

# 2.4/5.5 GHZ : WI-FI/BT/BLE Board Antenna



**PRO-IS-578**

Request Samples



Check Inventory



22.0 x 11.0 x 0.8mm  
RoHS/RoHS II Compliant  
MSL Level = 1

## Features

- Dual-Band coverage
- Thickness of 0.8 mm
- Linear Polarization
- Peak Gain of 2.5 dBi
- Efficiency > 33% (Lower band), >23% (Upper band)
- Easy integration using cable and connector
- Customizable cable and Connector options

## Applications

- Wi-Fi/BT/BLE applications
- IoT, M2M
- Industrial, Infrastructure IoT
- Smart Metering
- Consumer electronics
- Wireless modules
- Video and surveillance
- Broadband cellular connectivity

## Product Image



# 2.4/5.5 GHZ : WI-FI/BT/BLE Board Antenna



**PRO-IS-578**

Request Samples



Check Inventory



22.0 x 11.0 x 0.8mm  
RoHS/RoHS II Compliant  
MSL Level = 1

## Electrical Specification

Parameter	Specification		Unit
Operating Frequency	2400 ~ 2500	5150 ~ 5850	MHz
Return Loss	< -4.7	< -5.1	dB
Polarization	Linear		
Peak Gain	2.5	1.6	dBi
Efficiency	>33	>23	%
Impedance	50	50	$\Omega$

## Mechanical Specification

Parameter	Specification
Antenna Dimension	22 x 11.7 x 0.8 mm
Cable Type	Coaxial
Cable length	100 mm
Connector Type	MHF-4 (F)
Mounting Type	Adhesive

## Environmental Specification

Parameter	Specification
Operating Temperature	-40°C to +85°C
MSL Level	1
RoHS/RoHS II Compliant	Yes

# 2.4/5.5 GHZ : WI-FI/BT/BLE Board Antenna



**PRO-IS-578**

Request Samples



Check Inventory



22.0 x 11.0 x 0.8mm  
RoHS/RoHS II Compliant  
MSL Level = 1

## Product Dimensions

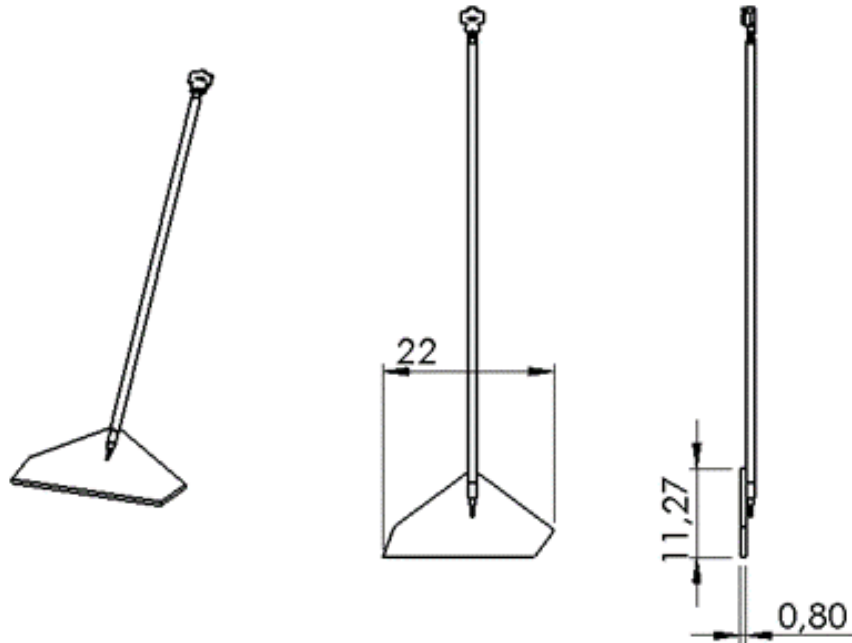

Unit: mm

## Measurement Setup

The antenna measurements were done on a standard measurement fixture - the antenna mounted in an ABS plastic box, 150x150x45 mm, connected to a PCB, 120x50 mm, with the cable fully extended.

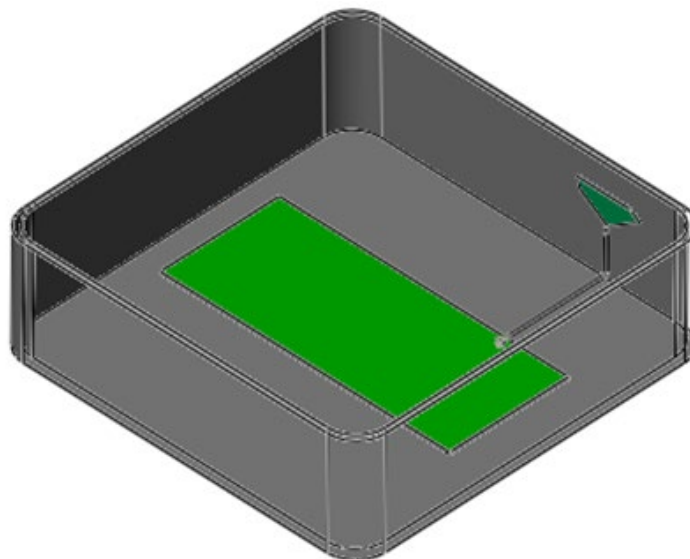

# 2.4/5.5 GHZ : WI-FI/BT/BLE Board Antenna



**PRO-IS-578**

Request Samples



Check Inventory



22.0 x 11.0 x 0.8mm  
RoHS/RoHS II Compliant  
MSL Level = 1

## Return Loss

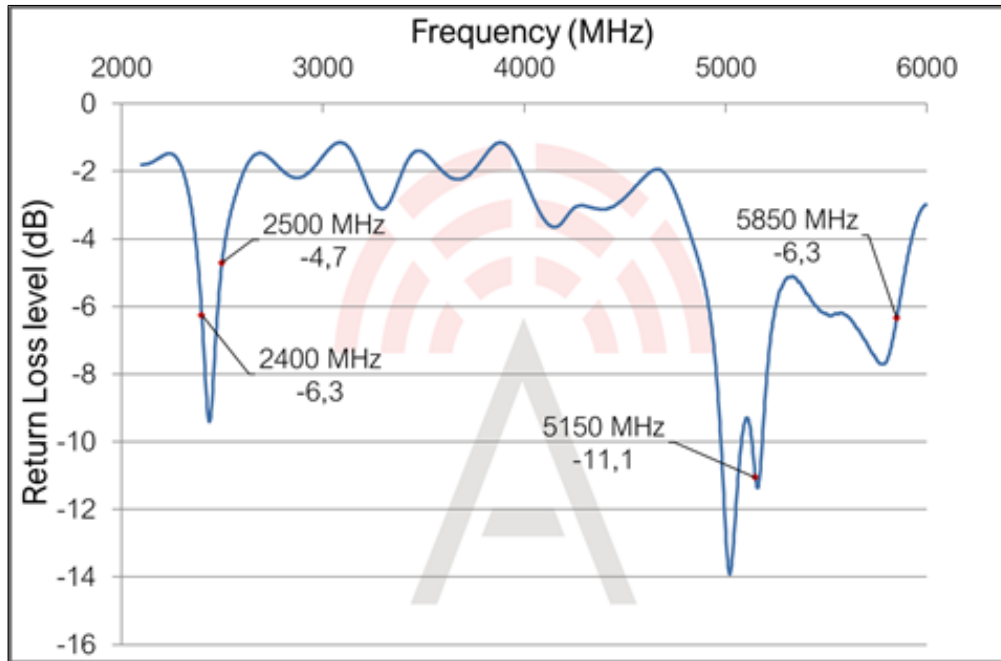

## Total Radiation Efficiency

## Maximum Radiation Gain

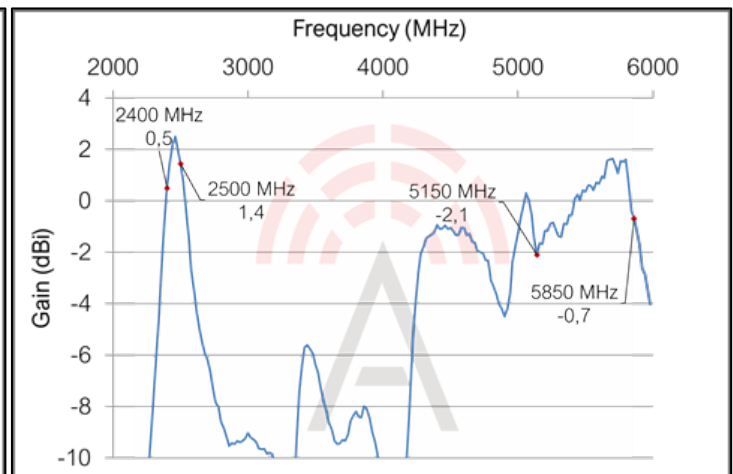
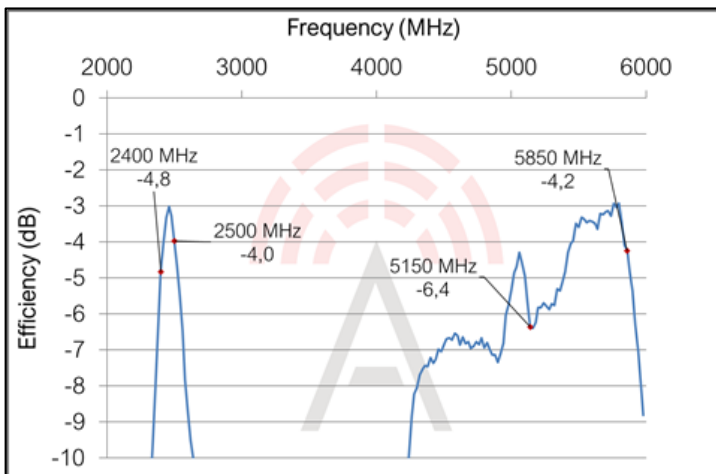

5101 Hidden Creek Ln Spicewood TX 78669  
Phone: 512-371-6159 | Fax: 512-351-8858  
For terms and conditions of sales, please visit:  
[www.abracon.com](http://www.abracon.com)

REVISED: 11-22-21

ABRACON IS  
ISO9001-2015  
CERTIFIED

# 2.4/5.5 GHZ : WI-FI/BT/BLE Board Antenna



**PRO-IS-578**

Request Samples



Check Inventory



22.0 x 11.0 x 0.8mm  
RoHS/RoHS II Compliant  
MSL Level = 1

## Radiation Characteristics - 2D Pattern (2.45 GHz)

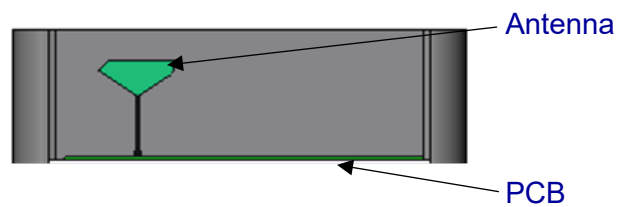
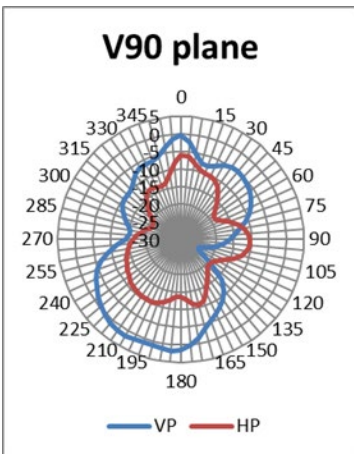
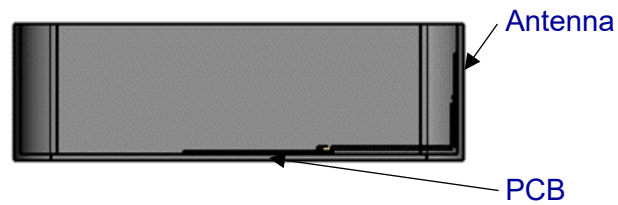
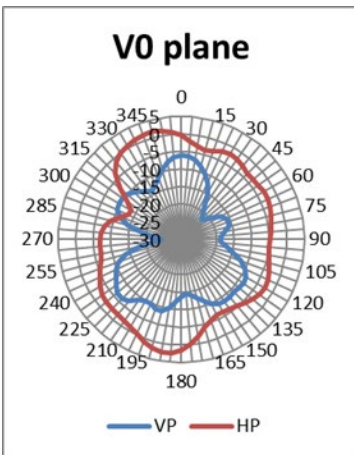
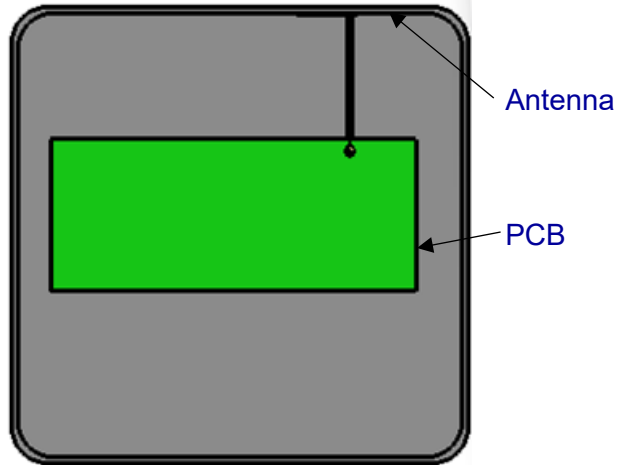
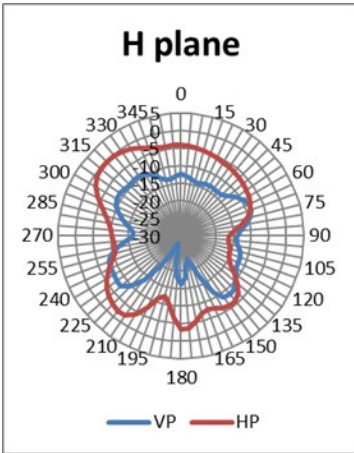

# 2.4/5.5 GHZ : WI-FI/BT/BLE Board Antenna



PRO-IS-578

Request Samples



Check Inventory



22.0 x 11.0 x 0.8mm  
RoHS/RoHS II Compliant  
MSL Level = 1

## Radiation Characteristics - 2D Pattern (5.15 GHz)

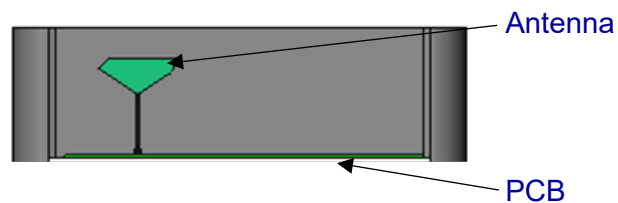
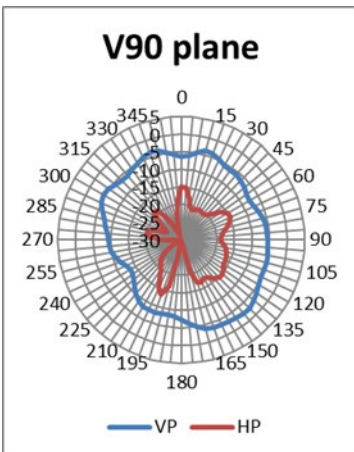
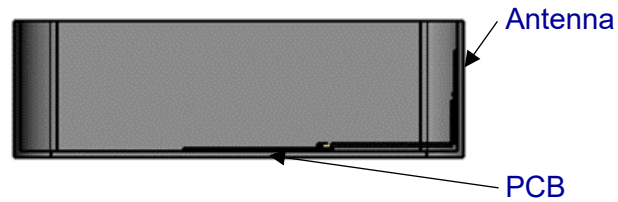
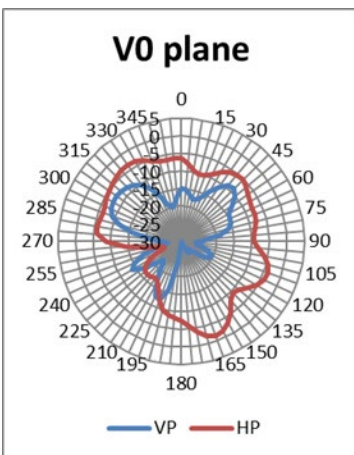
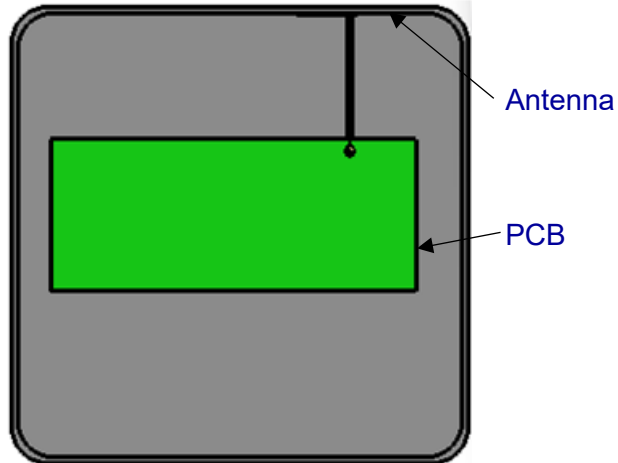
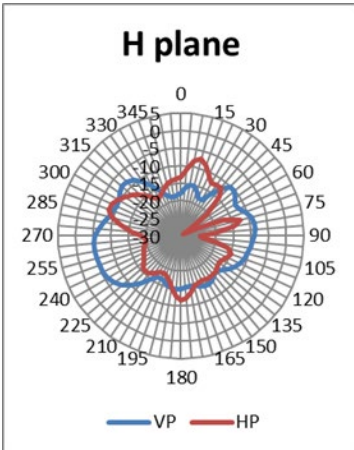

# 2.4/5.5 GHZ : WI-FI/BT/BLE Board Antenna



**PRO-IS-578**

Request Samples



Check Inventory



22.0 x 11.0 x 0.8mm  
RoHS/RoHS II Compliant  
MSL Level = 1

## Radiation Characteristics - 2D Pattern (5.85 GHz)

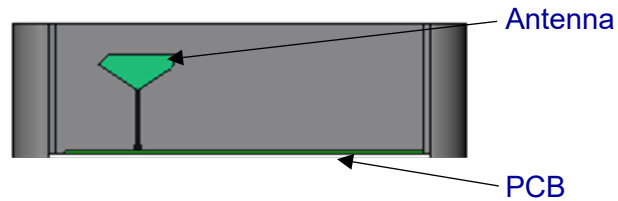
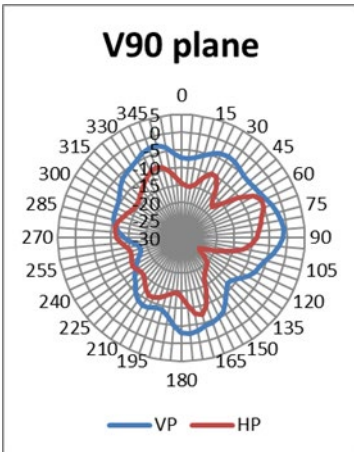
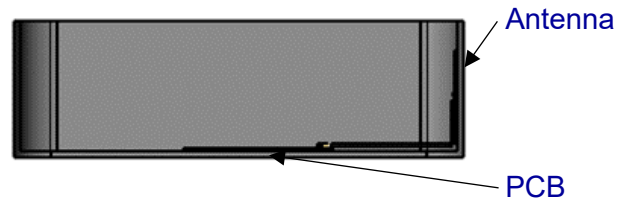
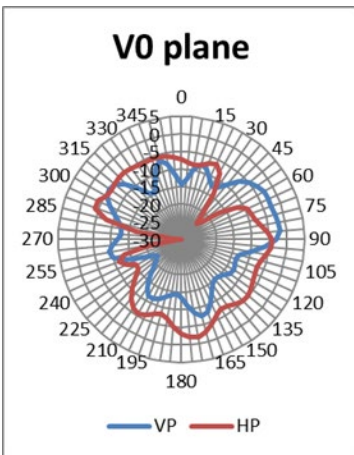
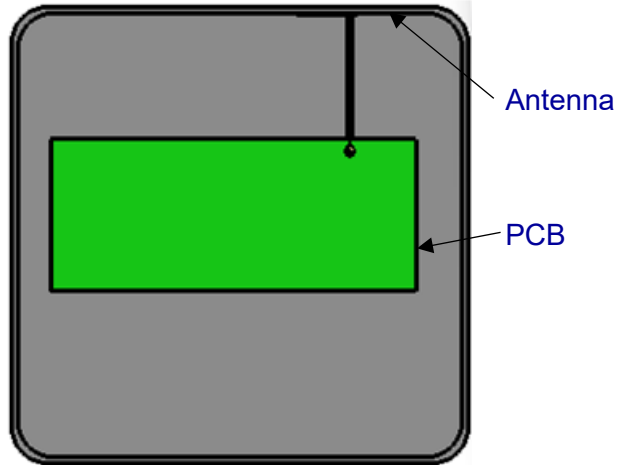
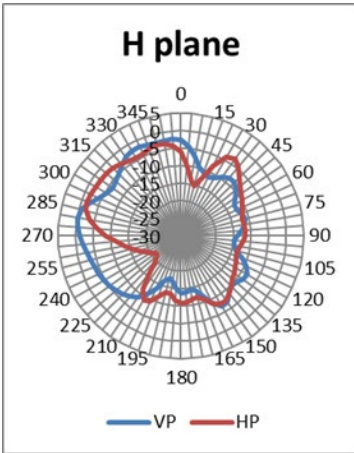

## 2.4/5.5 GHZ : WI-FI/BT/BLE Board Antenna



**PRO-IS-578**

Request Samples



Check Inventory



22.0 x 11.0 x 0.8mm  
RoHS/RoHS II Compliant  
MSL Level = 1

### Packaging Information

Pieces per bag: 100 pieces

**ATTENTION:** Abracon LLC's products are COTS – Commercial-Off-The-Shelf products; suitable for Commercial, Industrial and, where designated, Automotive Applications. Abracon's products are not specifically designed for Military, Aviation, Aerospace, Life-dependent Medical applications or any application requiring high reliability where component failure could result in loss of life and/or property. For applications requiring high reliability and/or presenting an extreme operating environment, written consent and authorization from Abracon LLC is required. Please contact Abracon LLC for more information.



5101 Hidden Creek Ln Spicewood TX 78669  
Phone: 512-371-6159 | Fax: 512-351-8858  
For terms and conditions of sales, please visit:  
[www.abracon.com](http://www.abracon.com)

**REVISED: 11-22-21**

ABRACON IS  
ISO9001-2015  
CERTIFIED