

2.4/5.5 GHz : Wi-Fi/BT/BLE Board Antenna



PRO-IS-432

Request Samples



Check Inventory



22.0 x 20.0 x 0.8mm
RoHS/RoHS II Compliant
MSL Level = 1

Features

- Compact 2.4/5.5 GHz square antenna
- Thickness of 0.8 mm
- Linear Polarization
- High Gain of 3.4 dBi
- Efficiency > 40%
- Easy integration using cable and connector
- Customizable cable and Connector options

Applications

- Wi-Fi/BT/BLE/ZigBee/ISM applications
- IoT/ M2M
- Wearables
- Automation/ Smart Home
- Healthcare Devices
- Hand-free/ PC Peripherals
- Video and surveillance

Product Image

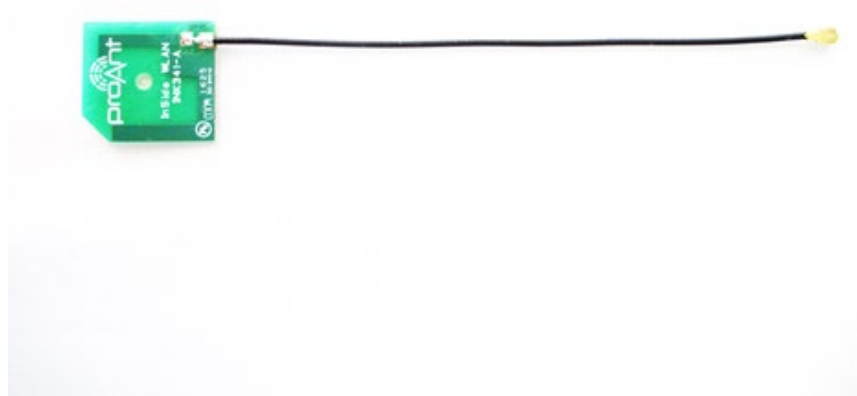

2.4/5.5 GHz : Wi-Fi/BT/BLE Board Antenna



PRO-IS-432

Request Samples



Check Inventory



22.0 x 20.0 x 0.8mm
RoHS/RoHS II Compliant
MSL Level = 1

Electrical Specification

Parameter	Specification		Unit
Operating Frequency	2400 ~ 2500	5150 ~ 5850	MHz
Return Loss	< -6.8	< -6.4	dB
Polarization	Linear		
Peak Gain	0.8	3.4	dBi
Efficiency	>54	>40	%
Impedance	50	50	Ω

Mechanical Specification

Parameter	Specification
Antenna Dimension	22 x 20 x 0.8 mm
Cable Type	Coaxial
Cable length	100 mm
Connector Type	MHF (F)
Mounting Type	Adhesive Tape

Environmental Specification

Parameter	Specification
Operating Temperature	-40°C to +85°C
MSL Level	1
RoHS/RoHS II Compliant	Yes



5101 Hidden Creek Ln Spicewood TX 78669
Phone: 512-371-6159 | Fax: 512-351-8858
For terms and conditions of sales, please visit:
www.abracon.com

REVISED: 11-22-21

ABRACON IS
ISO9001-2015
CERTIFIED

2.4/5.5 GHz : Wi-Fi/BT/BLE Board Antenna



PRO-IS-432

Request Samples



Check Inventory



22.0 x 20.0 x 0.8mm
RoHS/RoHS II Compliant
MSL Level = 1

Product Dimensions

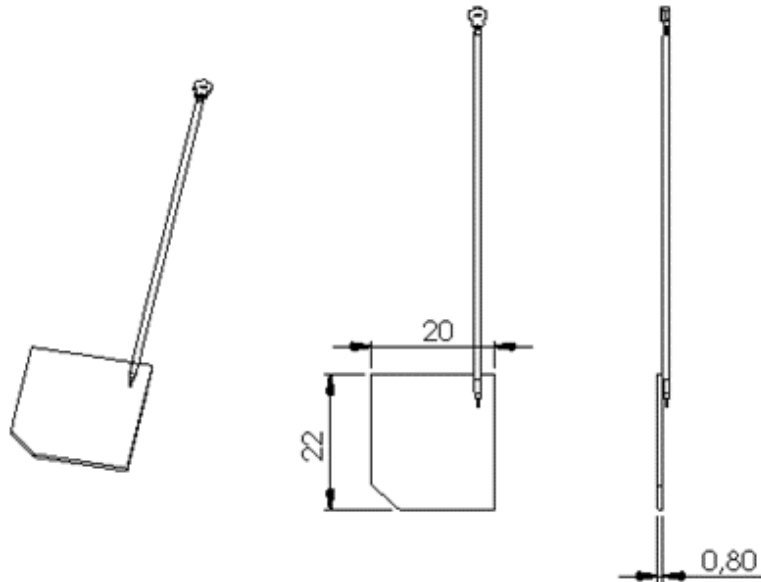

Unit: mm

Measurement Setup

The antenna measurements were done on a standard measurement fixture - the antenna mounted in an ABS plastic box, 150x150x45 mm, connected to a PCB, 120x50 mm, with the cable fully extended

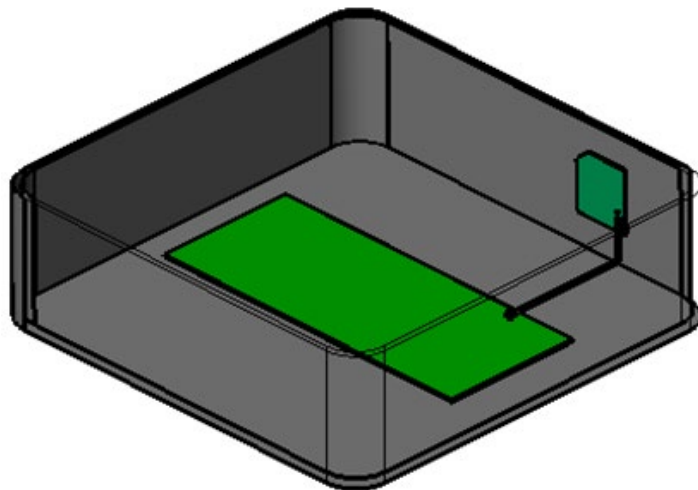

2.4/5.5 GHz : Wi-Fi/BT/BLE Board Antenna



PRO-IS-432

Request Samples



Check Inventory



22.0 x 20.0 x 0.8mm
RoHS/RoHS II Compliant
MSL Level = 1

Return Loss

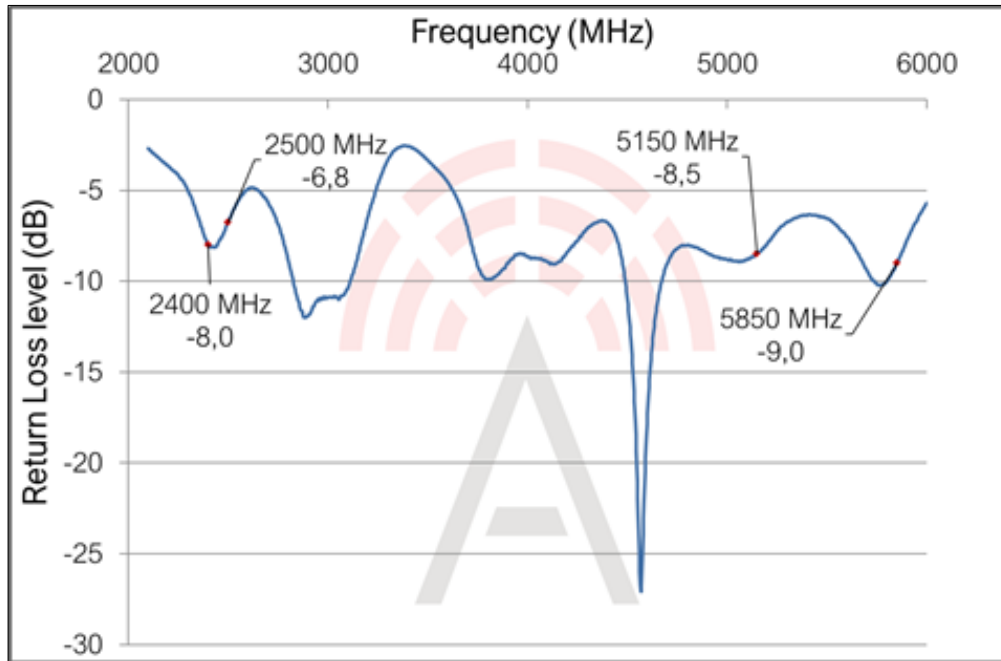

Total Radiation Efficiency

Maximum Radiation Gain

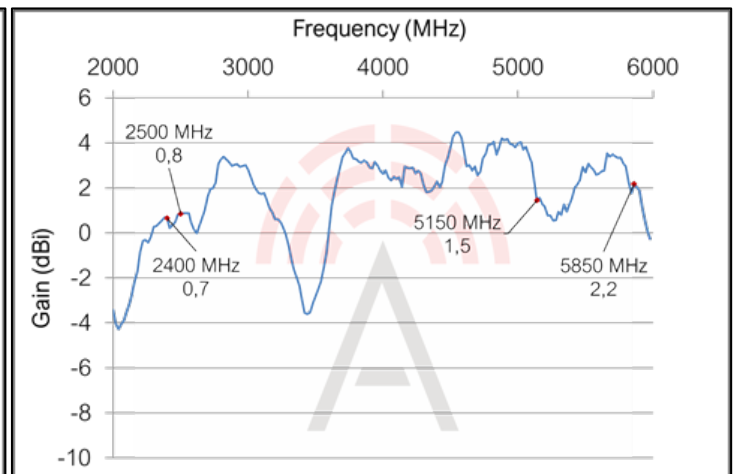
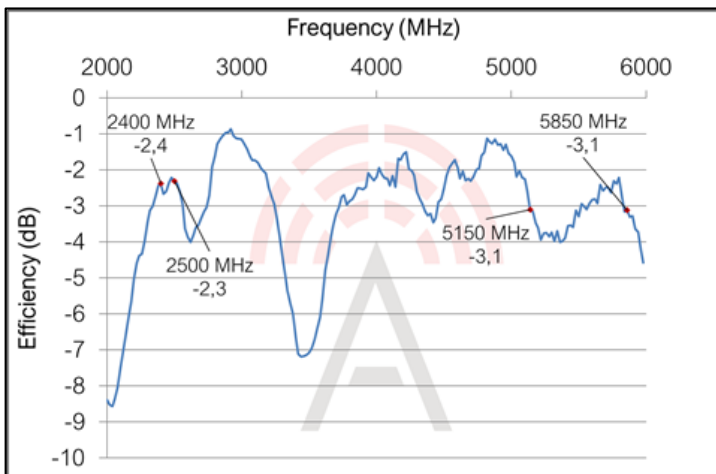

5101 Hidden Creek Ln Spicewood TX 78669
Phone: 512-371-6159 | Fax: 512-351-8858
For terms and conditions of sales, please visit:
www.abracon.com

REVISED: 11-22-21

ABRACON IS
ISO9001-2015
CERTIFIED

2.4/5.5 GHz : Wi-Fi/BT/BLE Board Antenna



PRO-IS-432

Request Samples



Check Inventory



22.0 x 20.0 x 0.8mm
RoHS/RoHS II Compliant
MSL Level = 1

Radiation Characteristics - 2D Pattern (2.45 GHz)

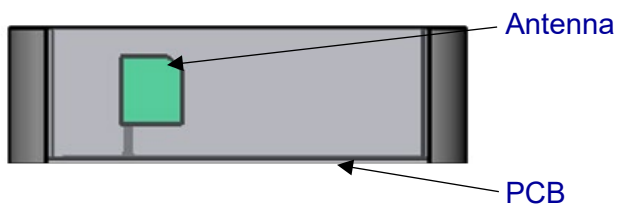
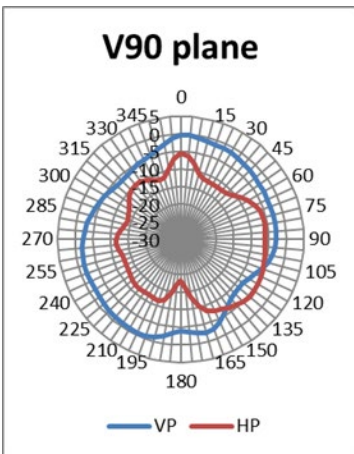
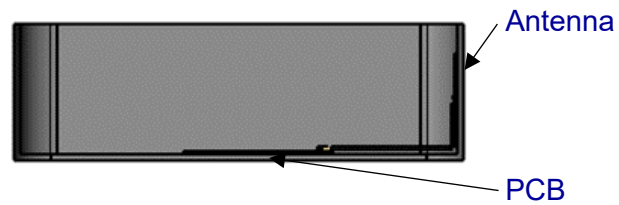
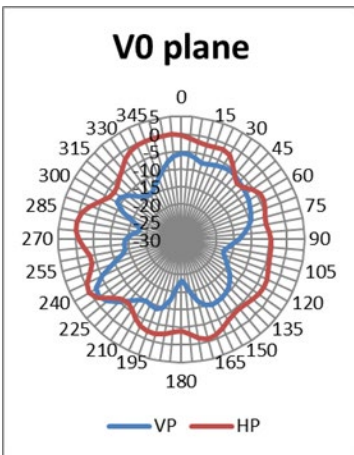
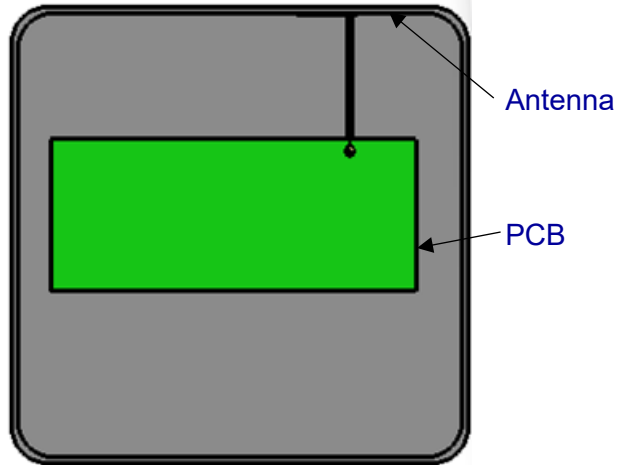
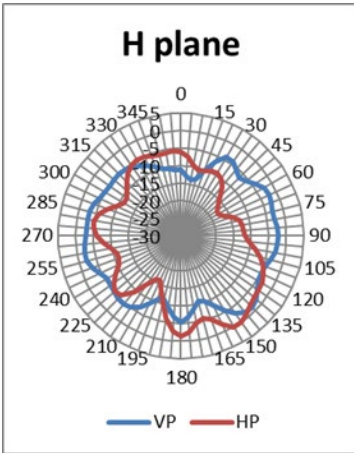

2.4/5.5 GHz : Wi-Fi/BT/BLE Board Antenna



PRO-IS-432

Request Samples



Check Inventory



22.0 x 20.0 x 0.8mm
RoHS/RoHS II Compliant
MSL Level = 1

Radiation Characteristics - 2D Pattern (5.15 GHz)

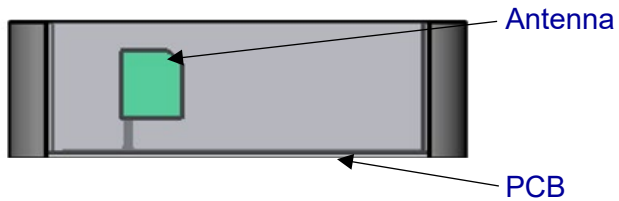
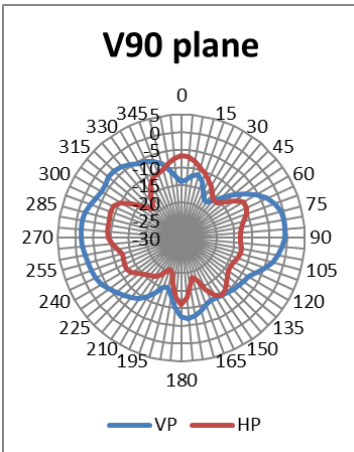
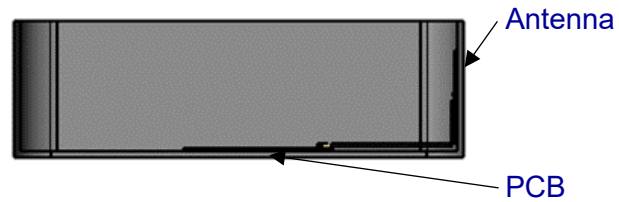
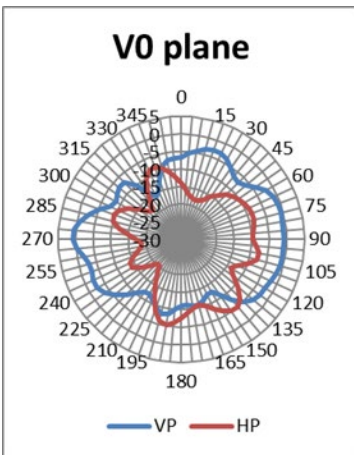
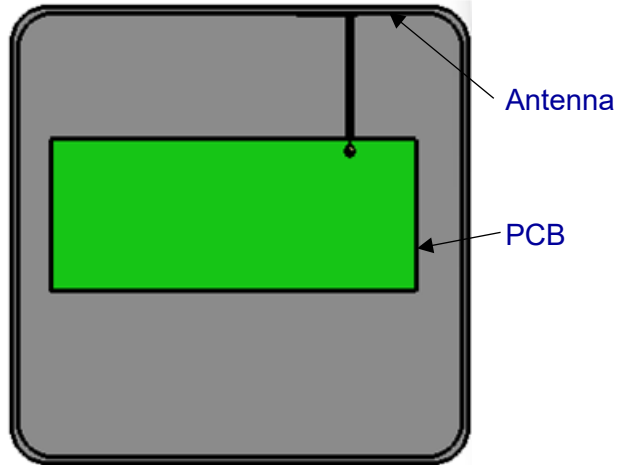
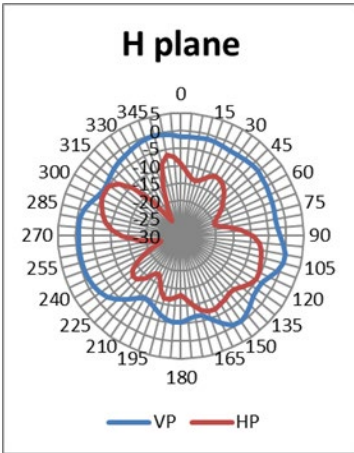

2.4/5.5 GHz : Wi-Fi/BT/BLE Board Antenna



PRO-IS-432

Request Samples



Check Inventory



22.0 x 20.0 x 0.8mm
RoHS/RoHS II Compliant
MSL Level = 1

Packaging Information

Pieces per bag: 100 pieces

ATTENTION: Abracon LLC's products are COTS – Commercial-Off-The-Shelf products; suitable for Commercial, Industrial and, where designated, Automotive Applications. Abracon's products are not specifically designed for Military, Aviation, Aerospace, Life-dependent Medical applications or any application requiring high reliability where component failure could result in loss of life and/or property. For applications requiring high reliability and/or presenting an extreme operating environment, written consent and authorization from Abracon LLC is required. Please contact Abracon LLC for more information.



5101 Hidden Creek Ln Spicewood TX 78669
Phone: 512-371-6159 | Fax: 512-351-8858
For terms and conditions of sales, please visit:
www.abracon.com

REVISED: 11-22-21

ABRACON IS
ISO9001-2015
CERTIFIED