

AVR-1F100705S

Request Samples



Check Inventory



10.0 x 6.8 x 5.0 mm
RoHS/RoHS II Compliant
 MSL Level = 1

Features

- Shielded construction
- Soft saturation
- High Power Density
- Low DCR, High Efficiency
- Perfect for multi-phased power circuitry.

Applications

- Desktop/ Server applications
- High current point-of-load (POL) converters
- Lighting
- Solar inverters and power
- Industrial and robotics
- Medium and high-power switch mode power supplies.

Electrical Specifications

Part Number	Inductance	Tolerance	DC Resistance	Saturation Current (Typ)			Temperature Rise Current
	0.1MHz/1.0V			@25°C	@100°C	@125°C	Min.
Units	nH	%	mΩ Max	A			A
Symbol	L		DCR	Isat			Irms
AVR-1F100705S70NK	70	±10%	0.1375	85	78	68	40
AVR-1F100705SR10K	100	±10%	0.1375	60	55	48	40
AVR-1F100705SR12K	120	±10%	0.1375	50	45	40	40
AVR-1F100705SR15K	150	±10%	0.1375	40	36	32	40
AVR-1F100705SR20K	200	±10%	0.1375	30	27	24	40
AVR-1F100705SR30K	300	±10%	0.1375	19	17	15	40

Test Conditions

Isat: DC current at which the inductance drops 30% from its value without current.

Irms: DC current that causes the temperature rise (ΔT , approximate 40 °C) from 20°C ambient

Operating Temperature: -40°C ~ +125°C (including self-temperature rise)

Storage Condition: -40°C ~ +85°C (with packaging) and R.H. <95% max

Operating Voltage: 40V (across inductor)

AVR-1F100705S Series is **RoHS Compliant and Pb free**

Part Identification

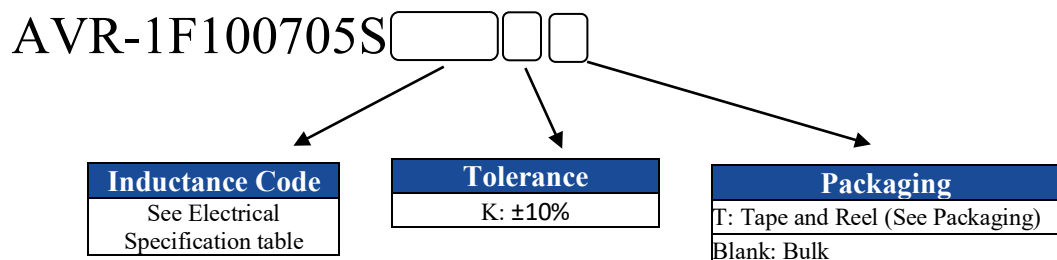

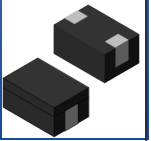

AVR-1F100705S

Request Samples



Check Inventory



10.0 x 6.8 x 5.0 mm
RoHS/RoHS II Compliant
MSL Level = 1

Mechanical Specifications

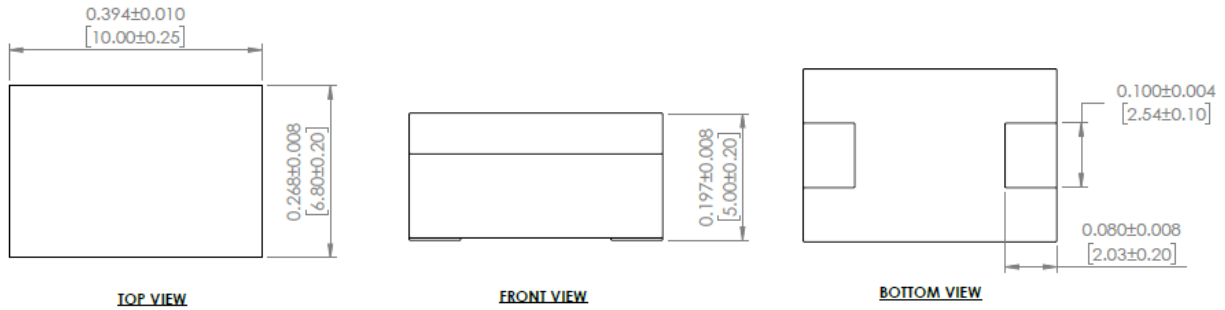

Dimensions: Inches [mm]

Recommended Land Pattern

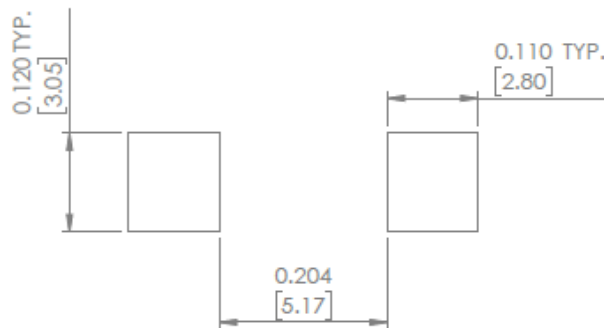

Dimensions: Inches [mm]

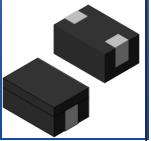

AVR-1F100705S

Request Samples



Check Inventory



10.0 x 6.8 x 5.0 mm
RoHS/RoHS II Compliant
MSL Level = 1

Reflow Profile

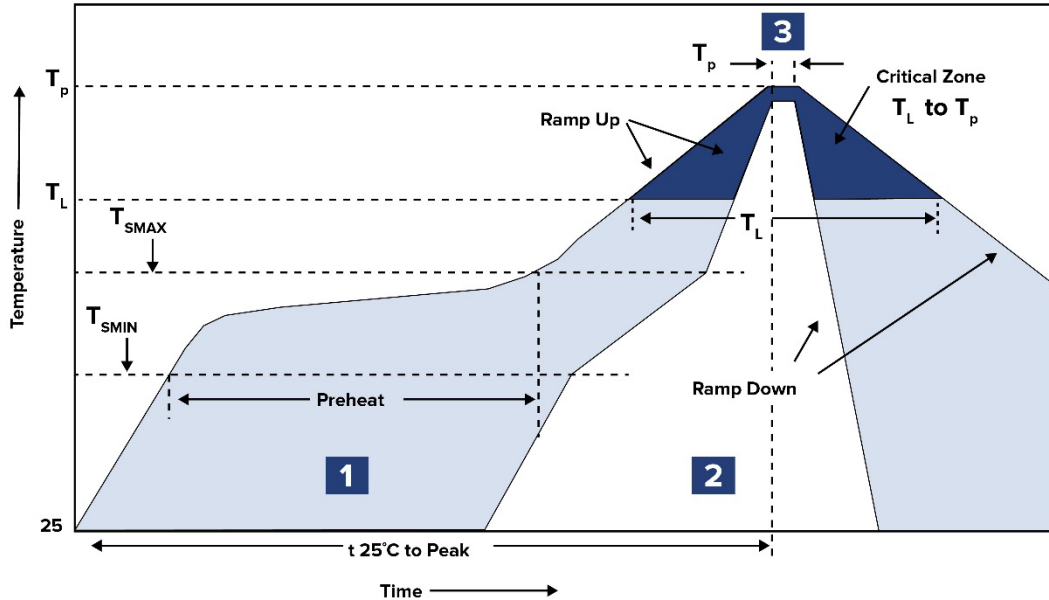

Zone	Description	Temperature	Times
1	Preheat	$T_{SMIN} \sim T_{SMAX}$ 150°C ~ 200°C	60 ~ 120 sec.
2	Reflow	T_L 217°C	60 ~ 150 sec.
3	Peak heat	T_P 260°C	5 sec. MAX

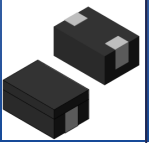

AVR-1F100705S

Request Samples



Check Inventory



10.0 x 6.8 x 5.0 mm
RoHS/RoHS II Compliant
MSL Level = 1

Packaging

Tape & Reel: 700 pcs/reel

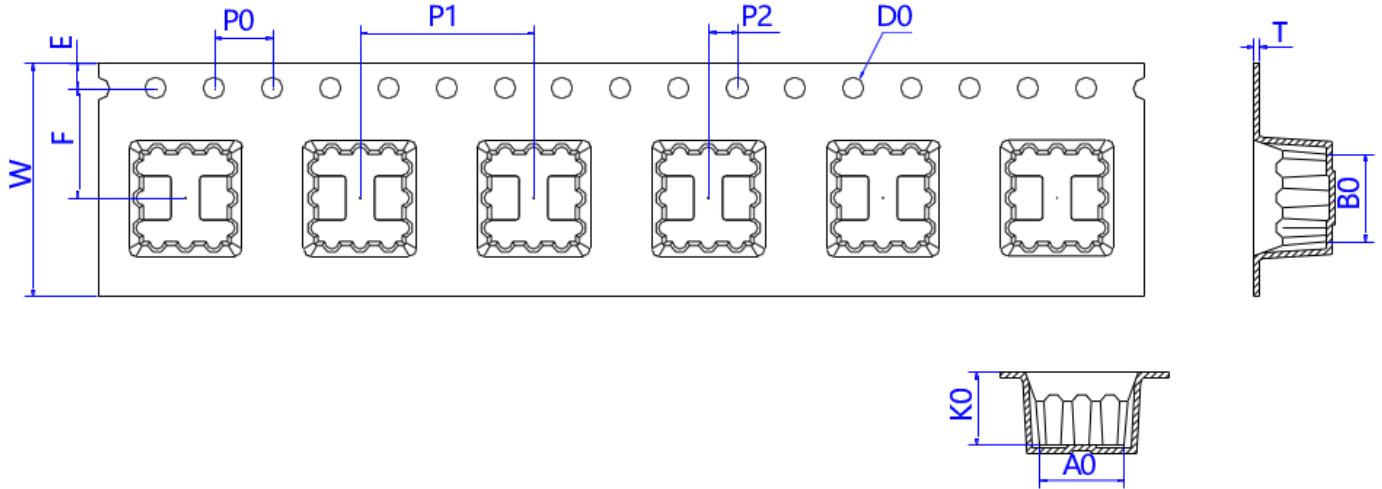

Series	W	E	F	P ₀	P ₁	P ₂	D ₀	A ₀	B ₀	T	K ₀
AVR-1F100705S	24.00 ± 0.30	1.75 ± 0.10	11.50 ± 0.10	4.0 ± 0.1	12.0 ± 0.1	2.0 ± 0.1	1.5 + 0.1/- 0.0	7.4 ± 0.10	11.4 ± 0.10	0.50 ± 0.03	5.7 ± 0.10

Dimensions: mm

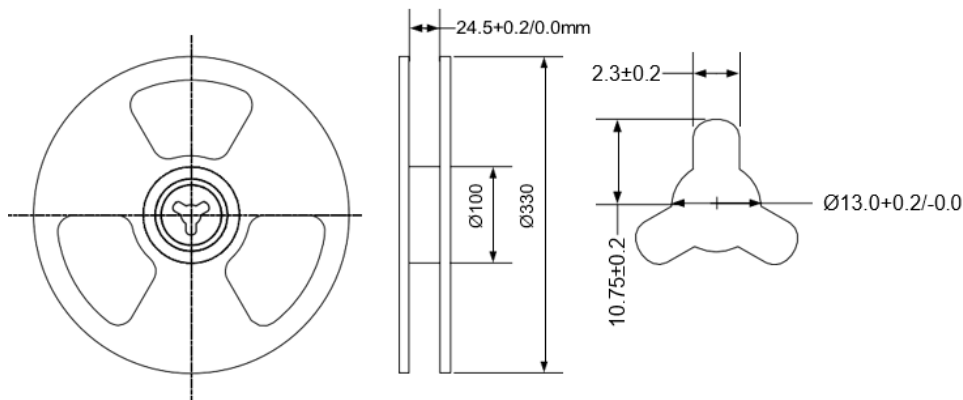

Dimensions: mm

ATTENTION: Abracon LLC's products are Commercial-Off-The-Shelf (COTS, which are designed, intended and validated for use in commercial, industrial and automotive applications. The customer is responsible for testing and verifying the performance of an Abracon solution to meet their system-level requirements.



5101 Hidden Creek Ln, Spicewood TX 78669
 Phone: 512-371-6159 Fax: 512-351-8858
 For terms and conditions of sales, please visit:
www.abracon.com

REVISION Initial Release :
12/2024

ABRACON IS
 ISO9001-2015
 CERTIFIED