

**AVR-1F060605S**

Request Samples



Check Inventory



5.5 x 5.7 x 4.6 mm  
**RoHS/RoHS II Compliant**  
 MSL Level = 1

## Features

- Shielded construction
- Soft saturation material
- High Power Density
- Low DCR, High Efficiency
- Perfect for Multi-Phased power circuitry

## Applications

- Desktop/ Server applications
- High current point-of-load (POL) converters
- Lighting
- Solar inverters and power
- Industrial and robotics
- Medium and high-power switch mode power supplies.

## Electrical Specifications

Part Number	Inductance	Tolerance	DC Resistance	Saturation Current (Typ)		Temperature Rise Current
	0.1MHz/1.0V		Max	@25°C	@100°C	Typ.
Units	nH	%	mΩ ±10%	A		A
Symbol	L		DCR	Isat		Irms
AVR-1F060605S55NL	55	±15%	0.20	63	46	34

### Test Conditions

**Isat:** DC current at which the inductance drops 30% from its value without current.

**Irms:** DC current that causes the temperature rise ( $\Delta T$ , approximate 40 °C) from 20°C ambient

**Operating Temperature:** -45°C ~ +125°C (including self-temperature rise)

**Storage Condition:** -40°C ~ +125°C (with packaging) and R.H. <95% max

**Operating Voltage:** 40V (across inductor)

AVR-1F060605S Series is **RoHS Compliant and Pb free**

## Part Identification

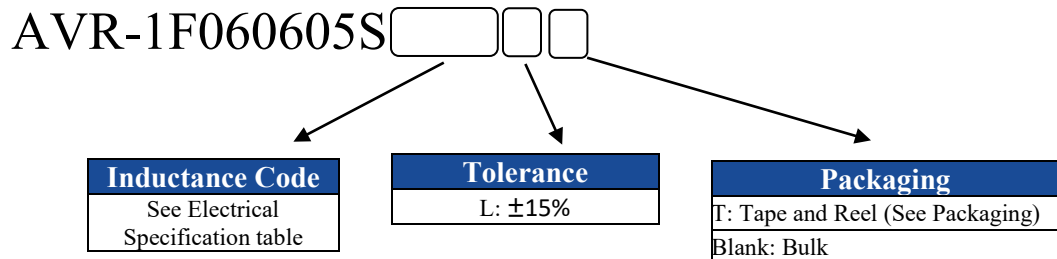

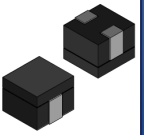

**AVR-1F060605S**

Request Samples



Check Inventory



**5.5 x 5.7 x 4.6 mm**  
**RoHS/RoHS II Compliant**  
**MSL Level = 1**

## Mechanical Specifications

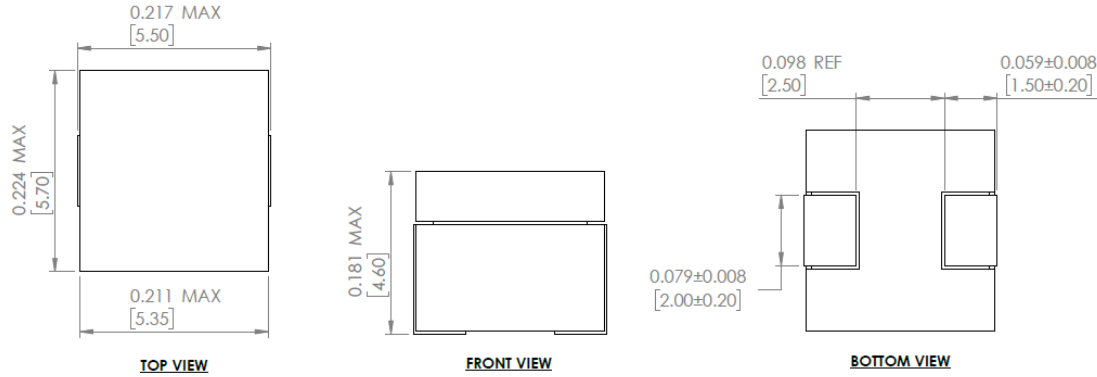

Dimensions: Inches [mm]

## Recommended Land Pattern

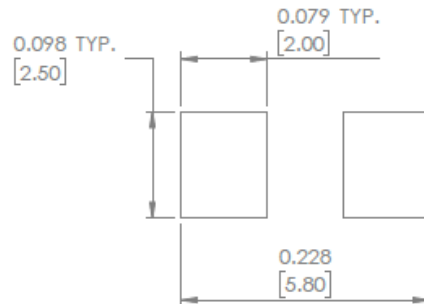

Dimensions: Inches [mm]

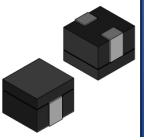

**AVR-1F060605S**

Request Samples



Check Inventory



5.5 x 5.7 x 4.6 mm  
**RoHS/RoHS II Compliant**  
 MSL Level = 1

## Reflow Profile

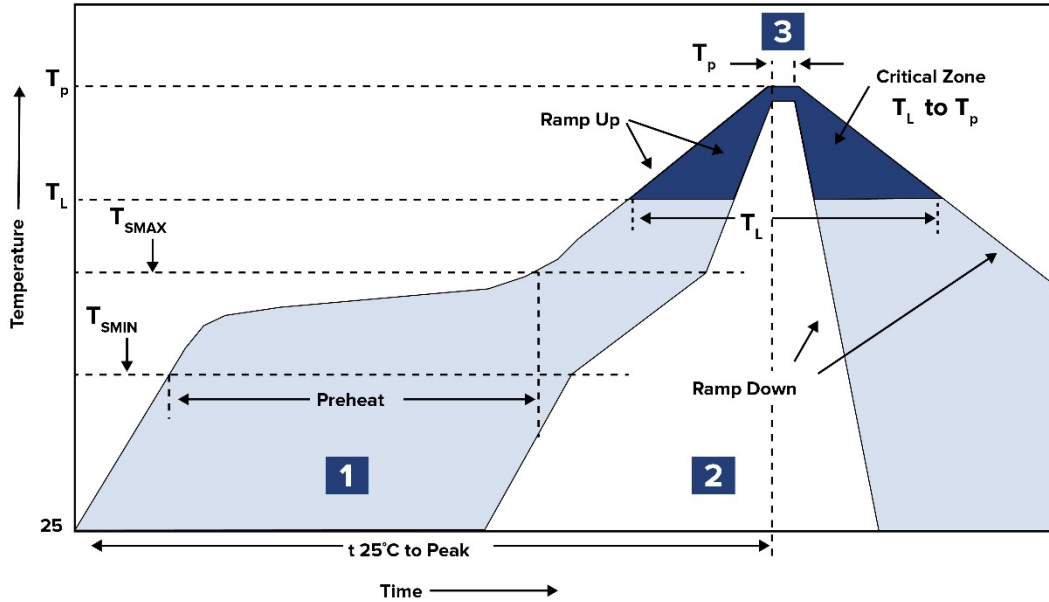

Zone	Description	Temperature	Times
1	Preheat	$T_{SMIN} \sim T_{SMAX}$ 150°C ~ 200°C	60 ~ 120 sec.
2	Reflow	$T_L$ 217°C	60 ~ 150 sec.
3	Peak heat	$T_P$ 260°C	5 sec. MAX

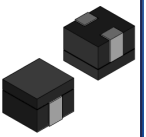

**AVR-1F060605S**

Request Samples



Check Inventory



5.5 x 5.7 x 4.6 mm  
**RoHS/RoHS II Compliant**  
 MSL Level = 1

## Packaging

**Tape & Reel: 1,000 pcs/reel**

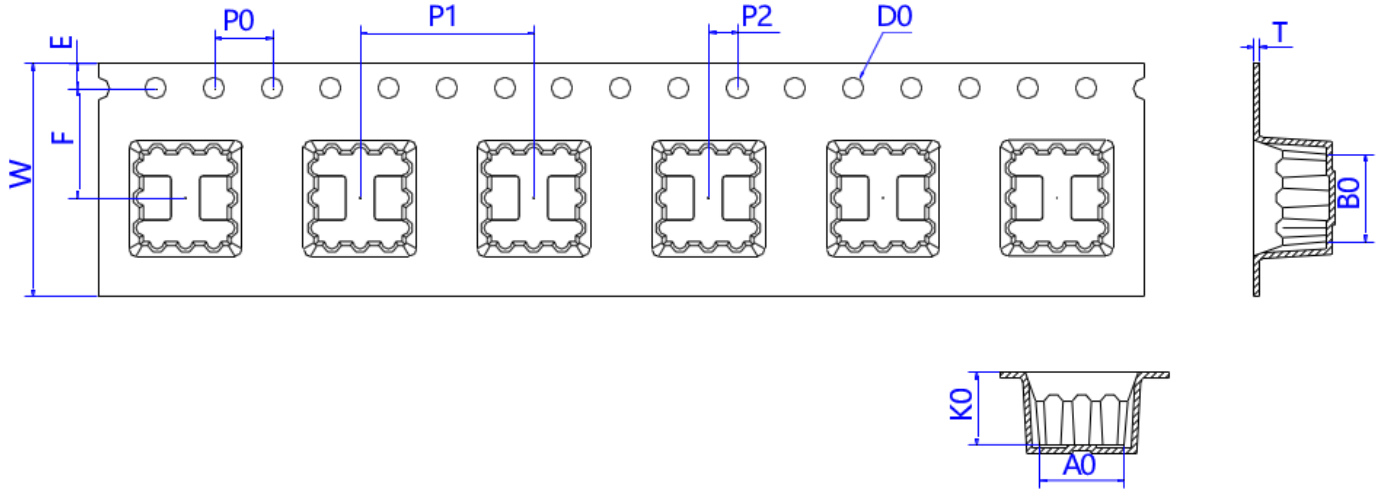

Series	W	E	F	P0	P1	P2	ΦD0	A <sub>0</sub>	B <sub>0</sub>	T	K <sub>0</sub>
AVR-1F060605S	16.00±0.30	1.75±0.10	7.50±0.10	4.00±0.10	12.00±0.10	2.00±0.10	1.50+0.10/-0.00	5.80±0.10	6.00±0.10	0.40±0.05	5.00±0.10

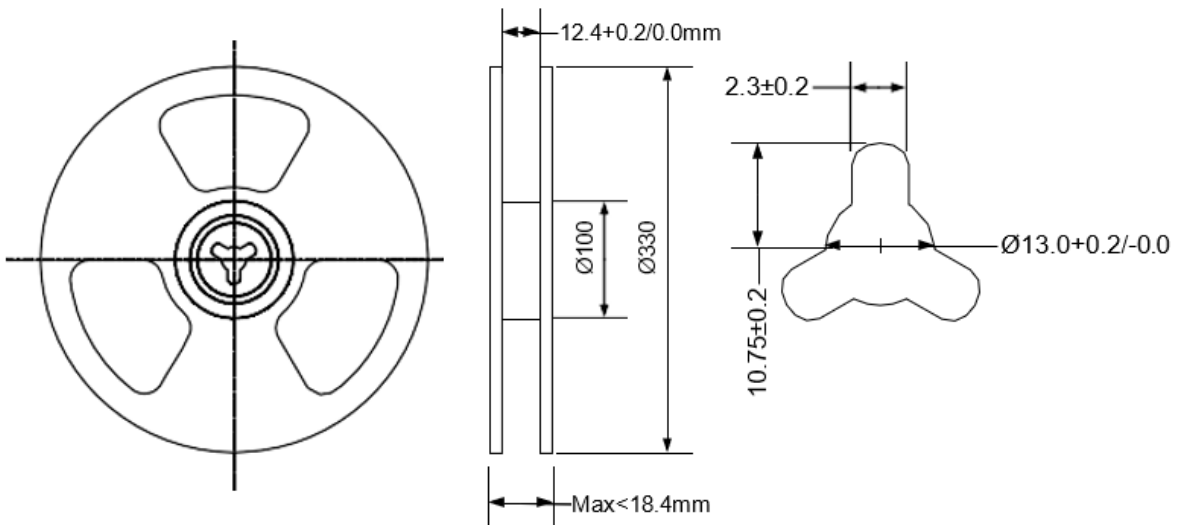

Dimensions: mm

**ATTENTION:** Abracon LLC's products are Commercial-Off-The-Shelf (COTS), which are designed, intended and validated for use in commercial, industrial and automotive applications. The customer is responsible for testing and verifying the performance of an Abracon solution to meet their system-level requirements.



5101 Hidden Creek Ln, Spicewood TX 78669  
 Phone: 512-371-6159 Fax: 512-351-8858  
 For terms and conditions of sales, please visit:  
[www.abracon.com](http://www.abracon.com)

**REVISION Initial Release :**  
 12/2/2024

ABRACON IS  
 ISO9001-2015  
 CERTIFIED