

AVR-1F040404S

Request Samples



Check Inventory



3.7 x 3.8 x 3.7~4.1 mm
RoHS/RoHS II Compliant
 MSL Level = 1

Features

- Shielded construction
- Soft saturation
- High Power Density
- Low DCR of 0.3mΩ, High Efficiency
- Perfect for multi-phased power circuitry

Applications

- Desktop/ Server applications
- High current point-of-load (POL) converters
- Lighting
- Solar inverters and power
- Industrial and robotics
- Medium and high-power switch mode power supplies.

Electrical Specifications

| Part Number | Inductance | Tolerance | DC Resistance | Saturation Current (Typ) | | Temperature Rise Current |
|-------------------|-------------|-----------|---------------|--------------------------|--------|--------------------------|
| | 0.1MHz/1.0V | | Max | @25°C | @100°C | Typ. |
| Units | nH | % | mΩ ±10% | A | | A |
| Symbol | L | | DCR | Isat | | Irms |
| AVR-1F040404S22NM | 22 | ±20% | 0.3 | 40 | 34 | 48 |
| AVR-1F040404S50NK | 50 | ±10% | | 35 | 30 | |
| AVR-1F040404S65NK | 65 | ±10% | | 30 | 23 | |
| AVR-1F040404SR10K | 100 | ±10% | | 17 | 15 | |

Test Conditions

Isat: DC current at which the inductance drops 30% from its value without current.

Irms: DC current that causes the temperature rise (ΔT , approximate 40 °C) from 20°C ambient

Operating Temperature: -45°C ~ +125°C (including self-temperature rise)

Storage Condition: -40°C ~ +125°C (with packaging) and R.H. <95% max

Operating Voltage: 40V (across inductor)

AVR-1F040404S Series is **RoHS Compliant and Pb free**

Part Identification

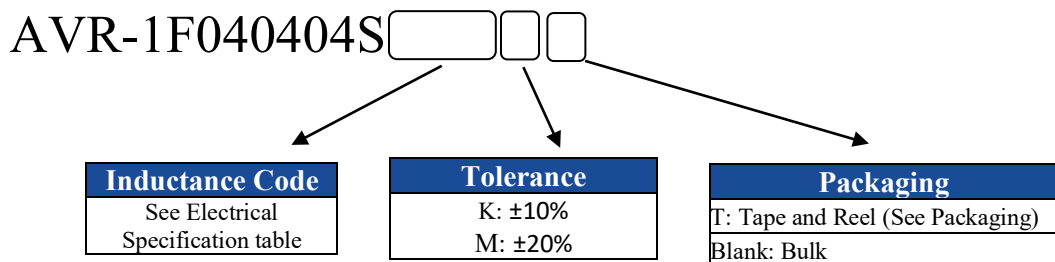

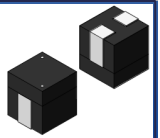

AVR-1F040404S

Request Samples



Check Inventory



3.7 x 3.8 x 3.7~4.1 mm
RoHS/RoHS II Compliant
 MSL Level = 1

Mechanical Specifications

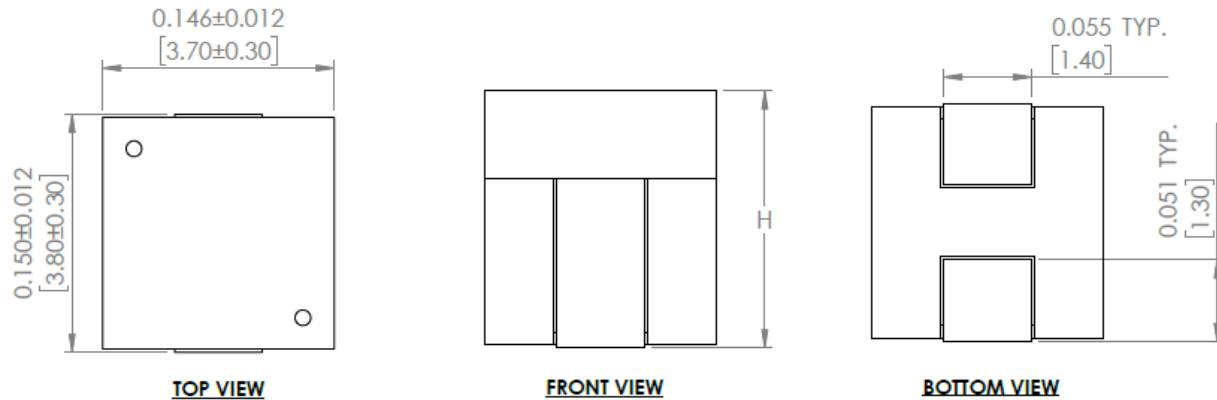

| Code | Series | Height,H |
|------|-------------------|---------------------------|
| H | AVR-1F040404S22NM | 0.161 [4.10] ±0.008[0.20] |
| | AVR-1F040404S50NK | 0.146 [3.70] ±0.012[0.30] |
| | AVR-1F040404S65NK | 0.146 [3.70] ±0.012[0.30] |
| | AVR-1F040404SR10K | 0.146 [3.70] ±0.012[0.30] |

Dimensions: Inches [mm]

Recommended Land Pattern

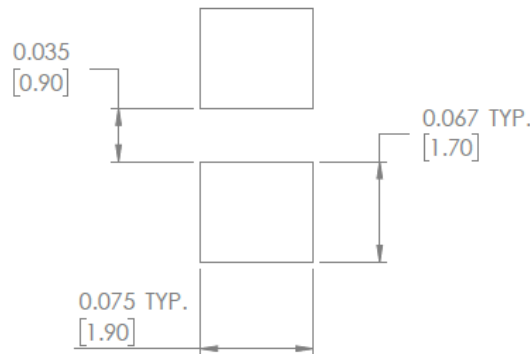

Dimensions: Inches [mm]

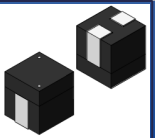

AVR-1F040404S

Request Samples



Check Inventory



3.7 x 3.8 x 3.7~4.1 mm
RoHS/RoHS II Compliant
 MSL Level = 1

Reflow Profile

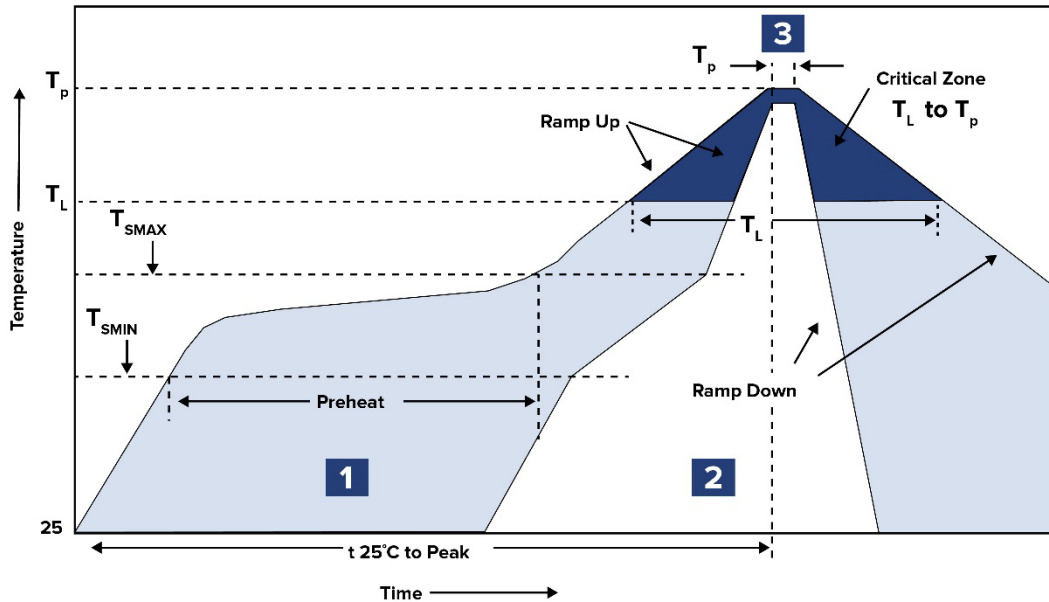

| Zone | Description | Temperature | Times |
|------|-------------|---|---------------|
| 1 | Preheat | $T_{SMIN} \sim T_{SMAX}$ 150°C ~ 200°C | 60 ~ 120 sec. |
| 2 | Reflow | T_L 217°C | 60 ~ 150 sec. |
| 3 | Peak heat | T_P 260°C | 5 sec. MAX |

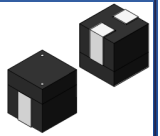

AVR-1F040404S

Request Samples



Check Inventory



3.7 x 3.8 x 3.7~4.1 mm
RoHS/RoHS II Compliant
 MSL Level = 1

Packaging

Tape & Reel: 1,500 pcs/reel

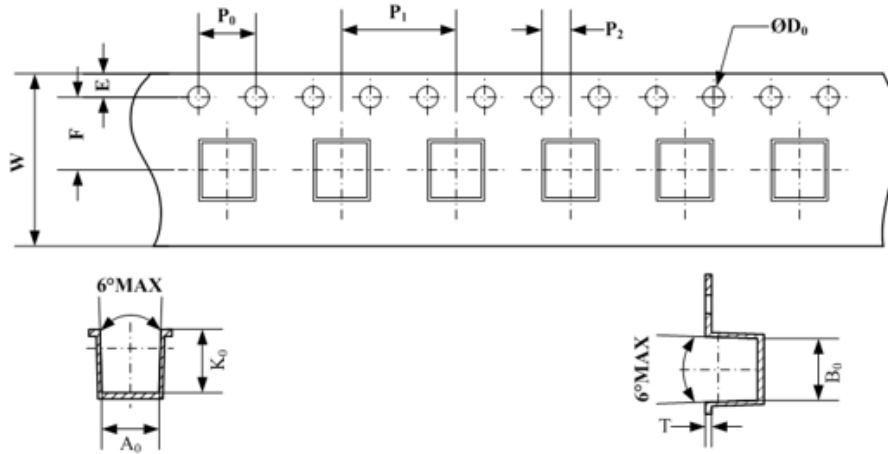

| Series | W | E | F | P ₀ | P ₁ | P ₂ | D ₀ | A ₀ | B ₀ | T | K ₀ |
|---------------|----------|----------|---------|----------------|----------------|----------------|----------------|----------------|----------------|-----------|----------------|
| AVR-1F040404S | 12.0±0.3 | 1.75±0.1 | 5.5±0.1 | 4.0±0.1 | 8.0±0.1 | 2.0±0.1 | 1.5+0.1/-0.0 | 4.2±0.1 | 4.4±0.1 | 0.40±0.05 | 4.2±0.1 |

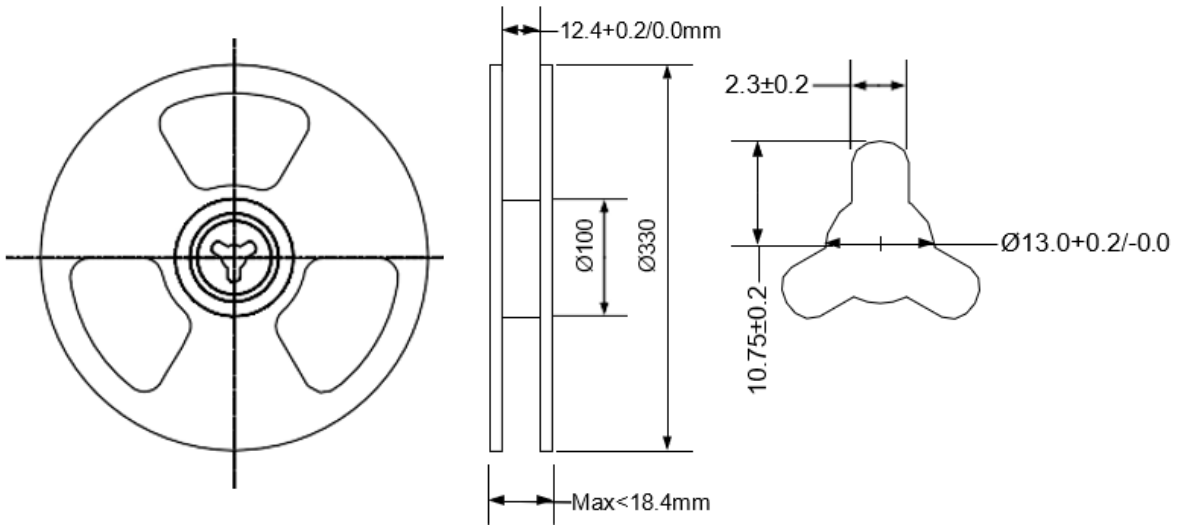

Dimensions: mm

ATTENTION: Abracon LLC's products are Commercial-Off-The-Shelf (COTS), which are designed, intended and validated for use in commercial, industrial and automotive applications. The customer is responsible for testing and verifying the performance of an Abracon solution to meet their system-level requirements.



5101 Hidden Creek Ln, Spicewood TX 78669
 Phone: 512-371-6159 Fax: 512-351-8858
 For terms and conditions of sales, please visit:
www.abracon.com

REVISION Initial Release :
 12/2/2024

ABRACON IS
 ISO9001-2015
 CERTIFIED