

32.768kHz CONTINUOUS VOLTAGE SMD CRYSTAL XO



ASEKDV

Request Samples



Check Inventory



ESD Sensitive



3.2 x 2.5 x 1.2 mm

RoHS/RoHS II Compliant

MSL Level = N/A

Features

- Continuous Vdd operation from 1.62 V ~ 3.63 V
- Optimized for low current consumption
- Output Enable/Start & Disable/Stop function
- Output waveform CMOS/LVCMOS compatible
- Hermetically seam-sealed ceramic package

Applications

- Portable & wearable electronics
- Internet of Things (IoT)
- Consumer electronics
- Industrial control & automation
- Mobile communication

Electrical Specifications

Parameters	Min.	Typ.	Max.	Units	Notes
Frequency		32.768		kHz	
Operating Temperature Range	-40.0		+85	°C	See options
Storage Temperature Range	-55.0		+125	°C	
Overall Frequency Stability [Note 1]	-25.0		+25	ppm	See options
Supply Voltage (Vdd)	+1.62		+3.63	V	
Tri-state function [Note 2]	“1” (VIH≥0.7*Vdd) or Open: Oscillation; “0” (VIL<0.3*Vdd): No Oscillation/Hi Z			V	
Output Load			15	pF	CMOS
Output Voltage	V _{OH}	0.9*Vdd		V	
	V _{OL}		0.1*Vdd		
Aging 1 year @25°C± 3°C	-3.0		+3.0	ppm	
Aging 5 years @25°C± 3°C	-5.0		+5.0	ppm	
Symmetry @ ½ Vdd	45	50	55	%	
Start-up Time			10	ms	
Rise and Fall Time (Tr/Tf) @10%Vdd-90%Vdd, 15pF load			30	ns	
Disable Current			5	µA	
Supply Current (Idd) @25°C± 3°C	Vdd = 3.3V	10	15	µA	No Load
	Vdd = 2.5V	9	14	µA	No Load
	Vdd = 1.8V	8	13	µA	No Load

Note 1: Overall frequency stability includes initial frequency tolerance @25°C± 3°C and stability over the operating temperature range.

Note 2: Do not leave pin 1 (INH) floating. If pin 1 (INH) is not utilized for toggling, it must be tied to Vdd (logic 1).

Part Identification

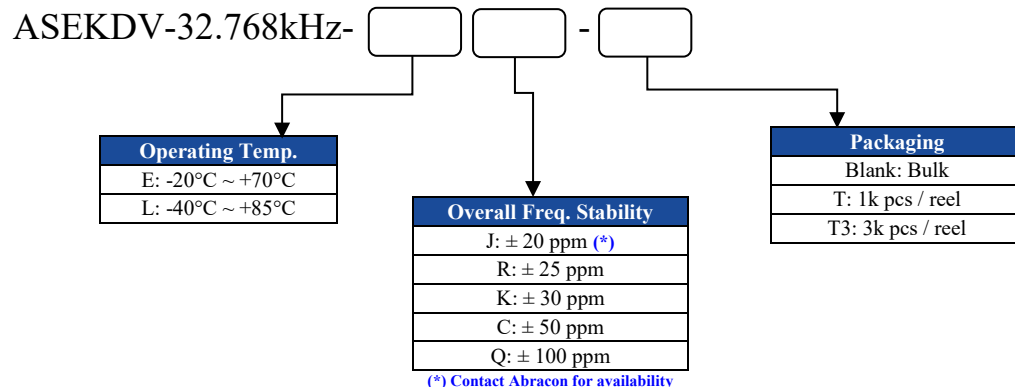

5101 Hidden Creek Ln Spicewood TX 78669
 Phone: 512-371-6159 | Fax: 512-351-8858
 For terms and conditions of sales, please visit:
www.abracon.com

REVISED: 11-11-20

ABRACON IS
 ISO9001-2015
 CERTIFIED

32.768kHz CONTINUOUS VOLTAGE SMD CRYSTAL XO



ASEKDV

Request Samples



Check Inventory



ESD Sensitive



3.2 x 2.5 x 1.2 mm
RoHS/RoHS II Compliant
MSL Level = N/A

Typical Current Consumption (I_{dd}) vs. Supply Voltage (V_{dd}) Characteristics [@ 25°C ± 3°C, No Load]

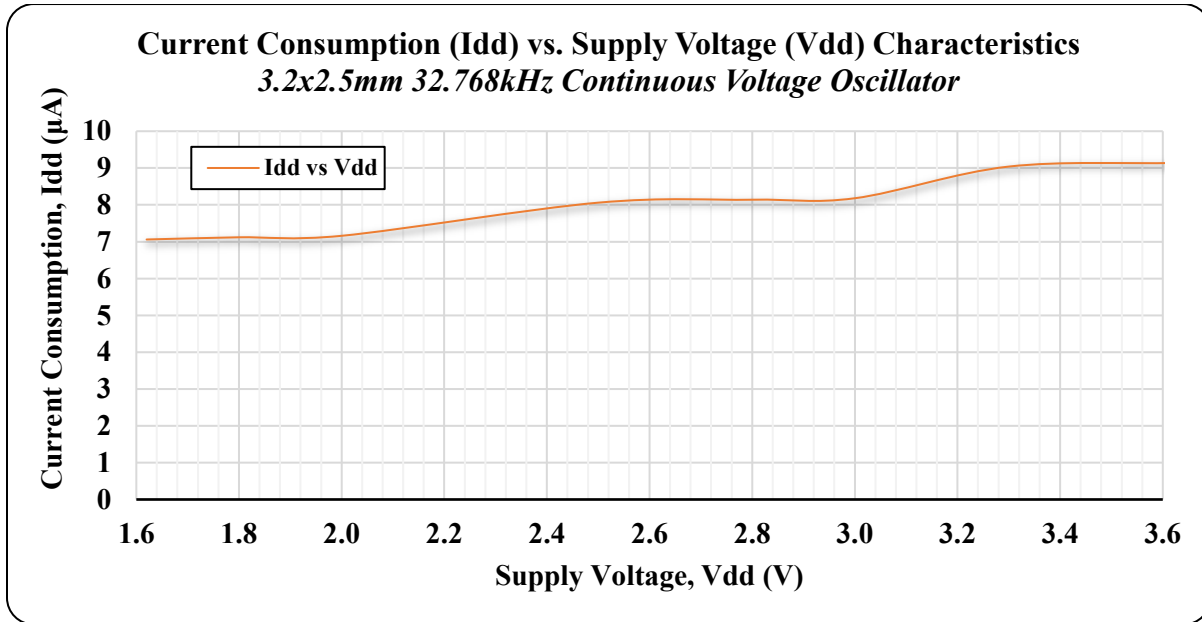

Typical Frequency vs. Supply Voltage (V_{dd}) Characteristics [@ 25°C ± 3°C, Normalized to V_{dd}=3.3Vdc]

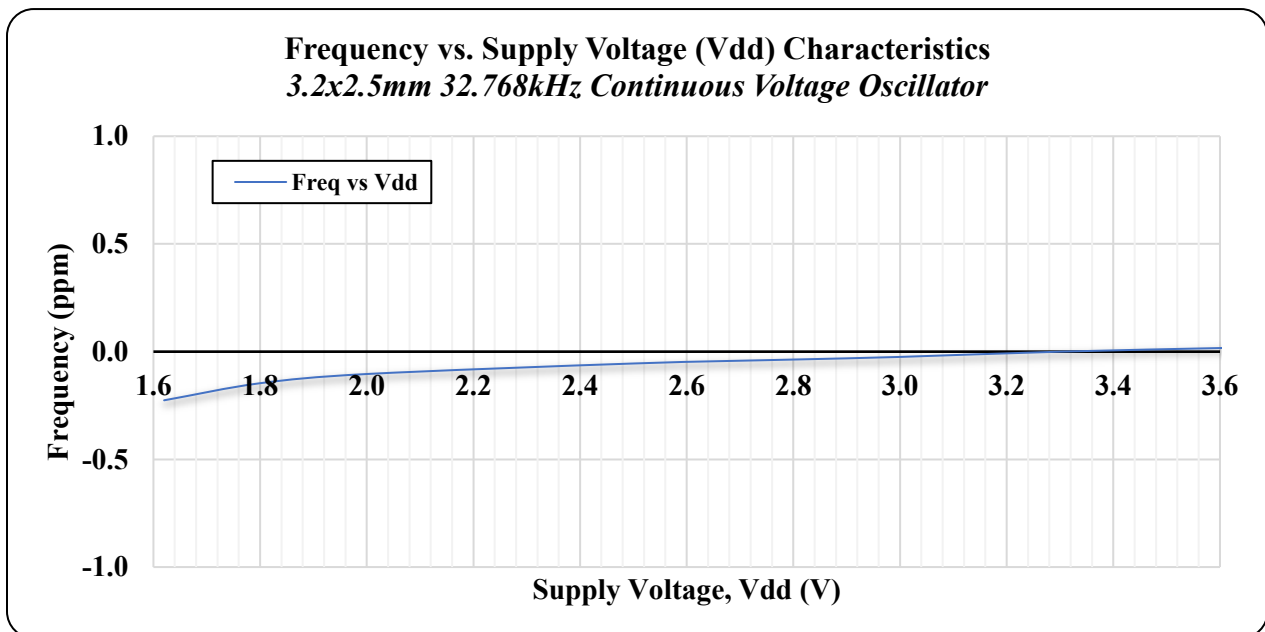

32.768kHz CONTINUOUS VOLTAGE SMD CRYSTAL XO



ASEKDV

Request Samples



Check Inventory



ESD Sensitive



3.2 x 2.5 x 1.2 mm
RoHS/RoHS II Compliant
MSL Level = N/A

Typical Frequency vs. Temperature Characteristics

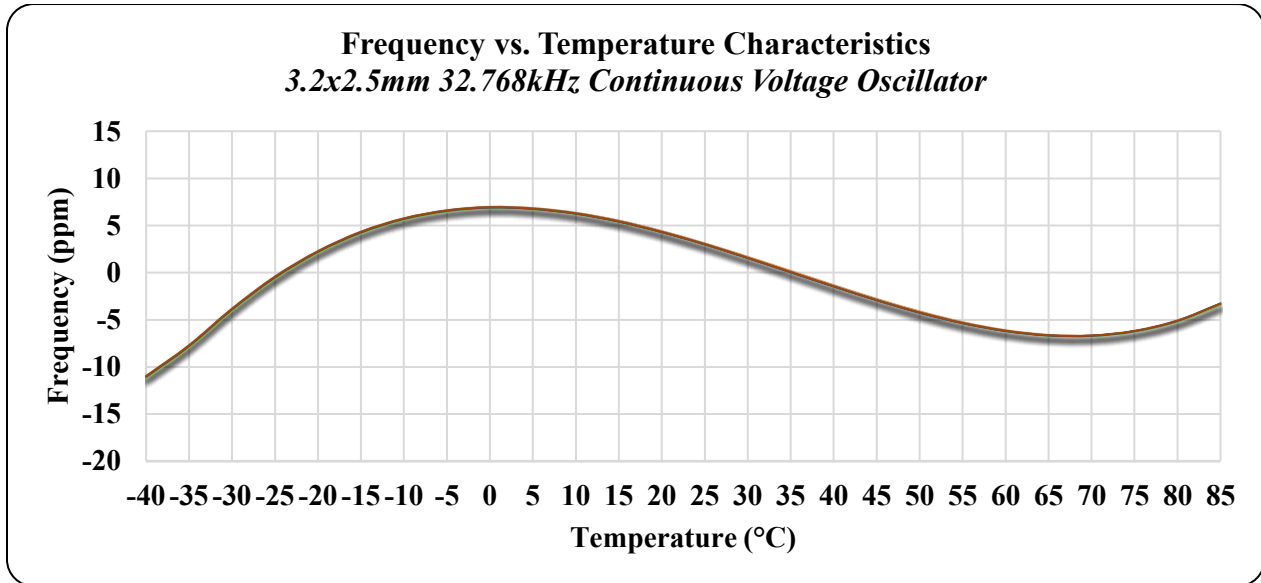

32.768kHz CONTINUOUS VOLTAGE SMD CRYSTAL XO



ASEKDV

Request Samples



Check Inventory



ESD Sensitive



3.2 x 2.5 x 1.2 mm
RoHS/RoHS II Compliant
 MSL Level = N/A

Mechanical Dimensions

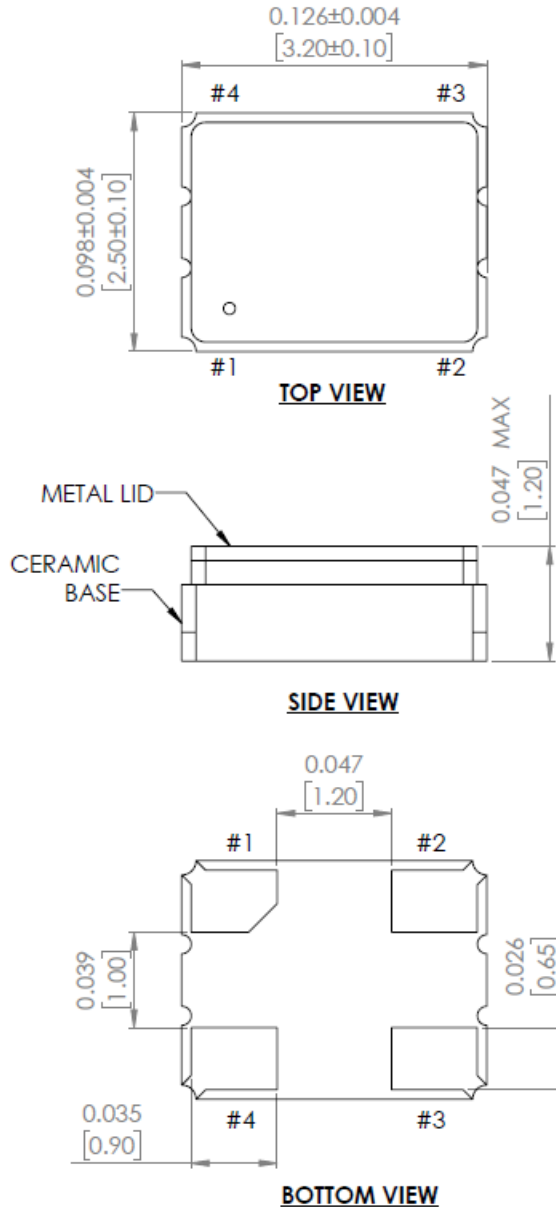

Recommended Land Pattern

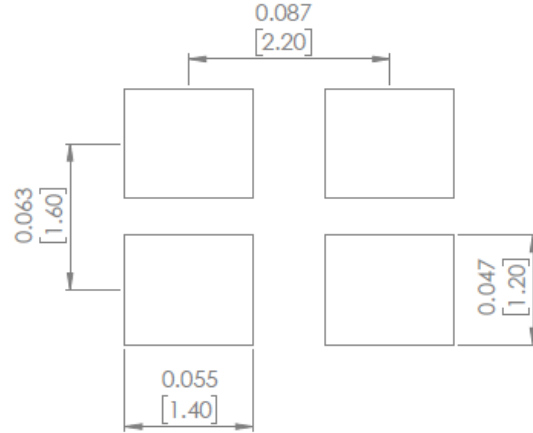

Pin #	Function
1	INH
2	GND
3	Output
4	Vdd

INH Function	
#1	#3 (Output)
Open	Active
"H" Level	Active
"L" Level	High Z (No Oscillation)

Note 3:

- Do not leave Pin 1 (INH) floating
- If Pin 1 (INH) is not utilized for toggling, it must be tied to Vdd (logic 1)

Note 4:

Recommended to use approximately 0.01µF bypass capacitor between PIN 2 and PIN 4

Dimensions: inches (mm)



5101 Hidden Creek Ln Spicewood TX 78669
 Phone: 512-371-6159 | Fax: 512-351-8858
 For terms and conditions of sales, please visit:
www.abracon.com

REVISED: 11-11-20

ABRACON IS
 ISO9001-2015
 CERTIFIED

32.768kHz CONTINUOUS VOLTAGE SMD CRYSTAL XO



ASEKDV

Request Samples



Check Inventory



ESD Sensitive



3.2 x 2.5 x 1.2 mm
RoHS/RoHS II Compliant
MSL Level = N/A

Reflow Profile [JDEC J-STD-020]

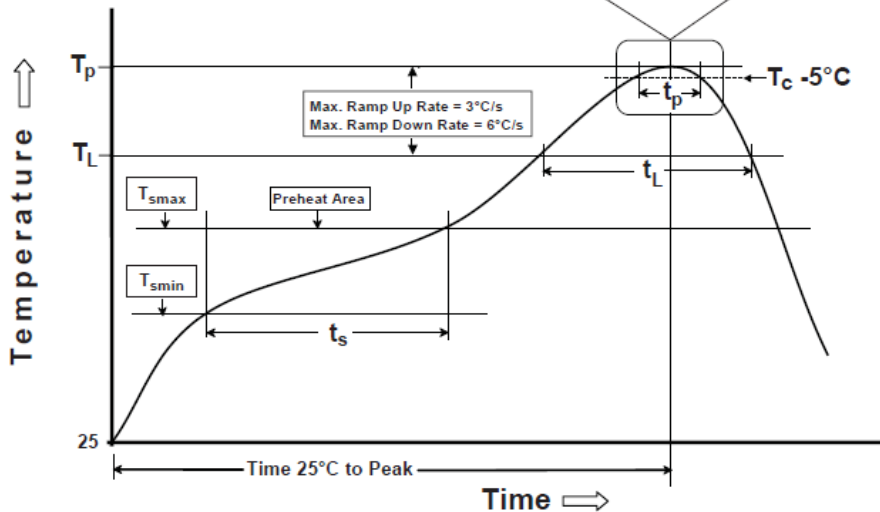
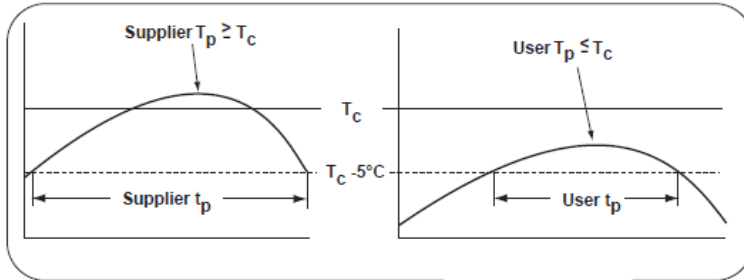

Table 1

SnPb Eutectic Process Classification Temperatures (T_c)

Package Thickness	Volume mm ³ <350	Volume mm ³ ≥350
<2.5 mm	235 °C	220 °C
≥2.5 mm	220 °C	220 °C

Table 2

Pb-Free Process Classification Temperatures (T_c)

Package Thickness	Volume mm ³ <350	Volume mm ³ 350-2000	Volume mm ³ >2000
<1.6 mm	260 °C	260 °C	260 °C
1.6 mm - 2.5 mm	260 °C	250 °C	245 °C
>2.5 mm	250 °C	245 °C	245 °C

Profile Feature	Sn-Pb Eutectic Assembly	Pb-Free Assembly
Preheat / soak		
Temperature minimum (T_{smin})	100°C	150°C
Temperature maximum (T_{smax})	150°C	200°C
Time (T_{smin} to T_{smax}) (t_s)	60 - 120 sec.	60 - 120 sec.
Average ramp-up rate (T_{smax} to T_p)	3°C/sec. max	3°C/sec. max
Liquidous temperature (T_L)	183°C	217°C
Time at liquidous (t_L)	60 - 150 sec.	60 - 150 sec.
Peak package body temperature (T_p)*	see Table 1	see Table 2
Time (t_p)** within 5°C of the specified classification temperature (T_c)	20 sec.	30 sec.
Ramp-down rate (T_p to T_{smax})	6°C/sec. max	6°C/sec. max
Time 25°C to peak temperature	6 min. max	8 min. max

*Tolerance for peak profile temperature (T_p) is defined as a supplier minimum and a user maximum.

**Tolerance for time at peak profile temperature (t_p) is defined as supplier minimum and a user maximum.



5101 Hidden Creek Ln Spicewood TX 78669
Phone: 512-371-6159 | Fax: 512-351-8858
For terms and conditions of sales, please visit:
www.abracon.com

REVISED: 11-11-20

ABRACON IS
ISO9001-2015
CERTIFIED

32.768kHz CONTINUOUS VOLTAGE SMD CRYSTAL XO



ASEKDV

Request Samples



Check Inventory



ESD Sensitive



3.2 x 2.5 x 1.2 mm
RoHS/RoHS II Compliant
MSL Level = N/A

Packaging

T: 1,000pcs/reel

T3: 3,000pcs/reel

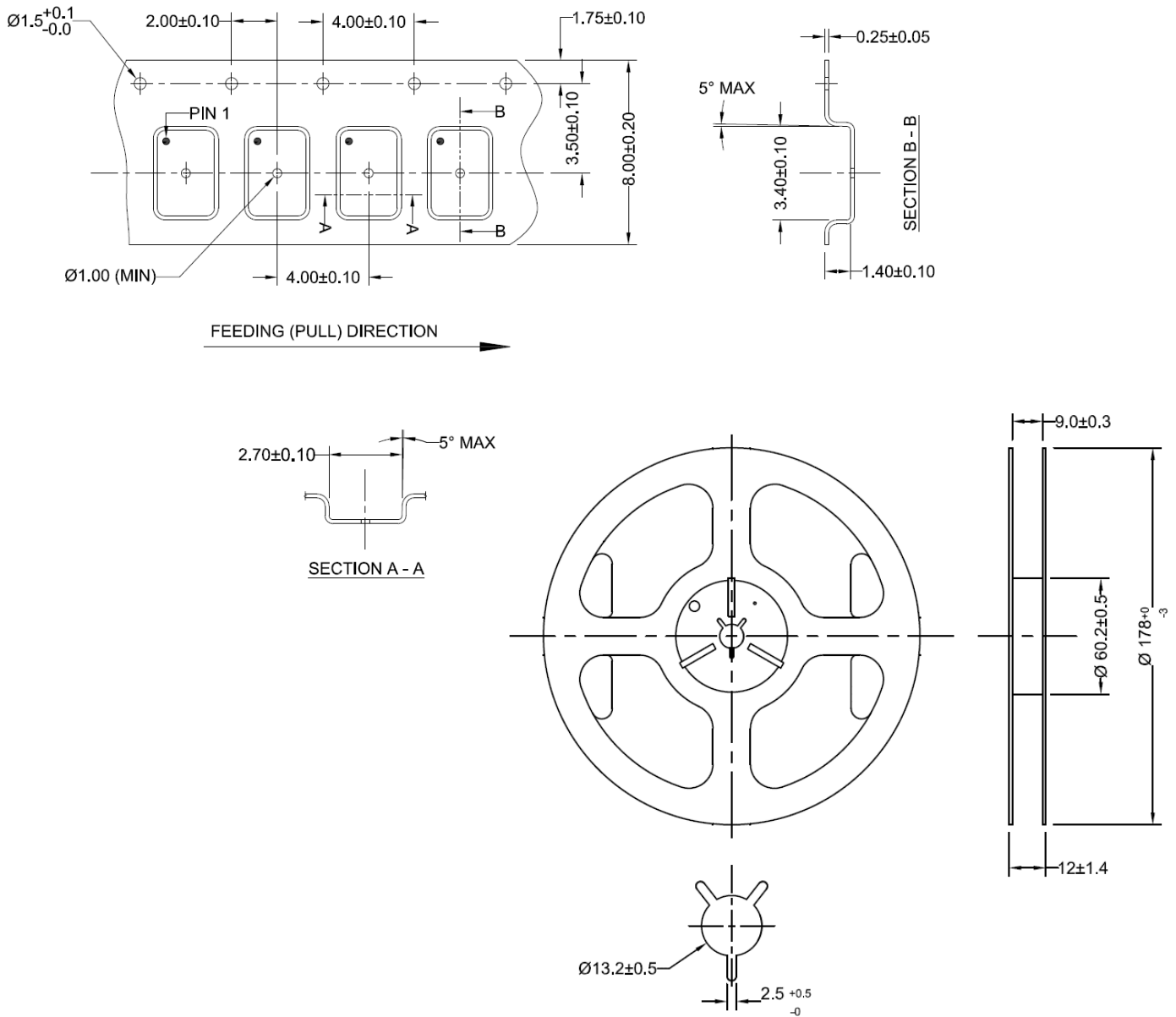

Dimensions: mm

ATTENTION: Abracon LLC's products are COTS – Commercial-Off-The-Shelf products; suitable for Commercial, Industrial and, where designated, Automotive Applications. Abracon's products are not specifically designed for Military, Aviation, Aerospace, Life-dependent Medical applications or any application requiring high reliability where component failure could result in loss of life and/or property. For applications requiring high reliability and/or presenting an extreme operating environment, written consent and authorization from Abracon LLC is required. Please contact Abracon LLC for more information.



5101 Hidden Creek Ln Spicewood TX 78669
Phone: 512-371-6159 | Fax: 512-351-8858
For terms and conditions of sales, please visit:
www.abracon.com

REVISED: 11-11-20

ABRACON IS
ISO9001-2015
CERTIFIED