

# Full-Band Internal Active High-Precision GNSS Antenna



**APXG6413GH-0600A**

Request Samples



Check Inventory



64 x 64 x 13.4 mm

RoHS/RoHS II Compliant

MSL Level = N/A

## Features

- Multiband Active GNSS  
GPS: L1/L2/L5  
GLONASS: G1/G2/G3  
Galileo: E1/E5a/E5b/E6  
Beidou: B1/B2/B3  
QZSS: L1/L2/L5/L6  
SBAS: L1/E1/B1, L5/B2a/E5a  
L-band correction service
- Active GNSS patch with LNA max gain of 33±2 dB
- Centimeter phase center repeatability
- Pre-filtered LNA to minimize de-sensing
- Strong anti-interference performance
- Low profile, light weight, low power Consumption

## Applications

- Autonomous driving and UAVs
- Precision land survey positioning
- Surveying and mapping systems
- Precision agriculture
- Tri-band RTK and PPP receivers
- Mission-critical GNSS timing
- Geofencing

## Product Image

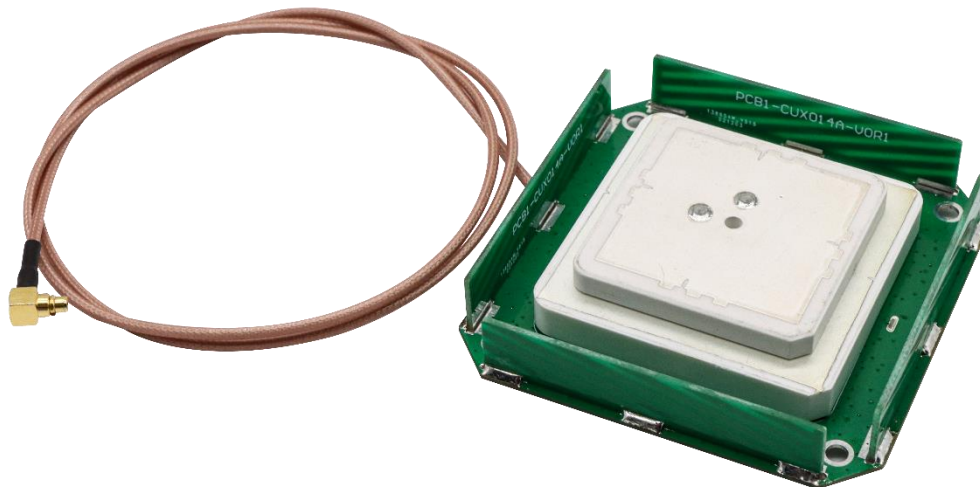

# Full-Band Internal Active High-Precision GNSS Antenna



**APXG6413GH-0600A**

Request Samples



Check Inventory



**64 x 64 x 13.4 mm**  
**RoHS/RoHS II Compliant**  
**MSL Level = N/A**

## GNSS Frequency Bands Covered

System	Band	Frequency Range	Band	Frequency Range	Band	Frequency Range	Band	Frequency Range
GPS	L1	1575.42MHz	L2	1227.6MHz	L5	1176.45MHz		
		■		■		■		
GLONASS	G1	1598.06-1609.31MHz	G2	1242.93-1251.68MHz	G3	1202.025MHz		
		■		■		■		
Galileo	E1	1575.42MHz	E5a	1176.45MHz	E5b	1201.5MHz	E6	1278.75MHz
		■		■		■	■	
BeiDou	B1	1561MHz	B2	1207.14MHz	B3	1268.52MHz		
		■		■		■		
QZSS	L1	1575.42MHz	L2	1227.6MHz	L5	1176.45MHz	L6	1278.75MHz
		■		■		■	■	
IRNSS/NAVIC					L5	1176.45MHz		
						■		
SBAS	L1/E1/B1	1575.42MHz			L5/B2a/E5a	1176.45MHz		
		■				■		

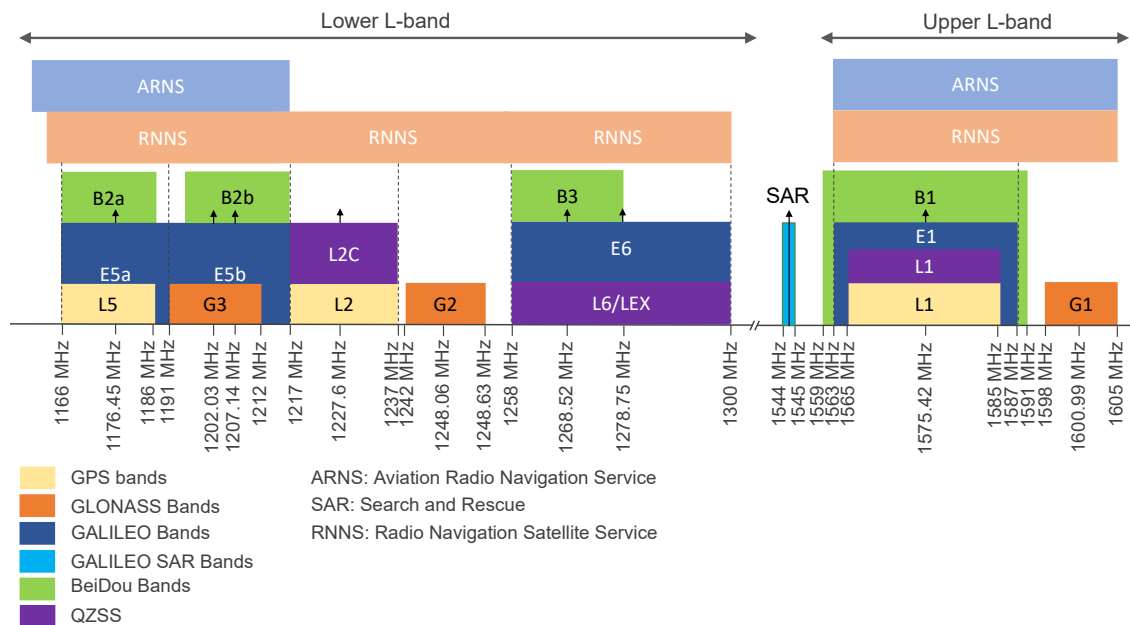

Frequency allocation: GNSS systems, upper L bands and lower L bands



5101 Hidden Creek Ln Spicewood TX 78669  
 Phone: 512-371-6159 | Fax: 512-351-8858  
 For terms and conditions of sales, please visit:  
[www.abracon.com](http://www.abracon.com)

**REVISED: 04-26-23**

ABRACON IS  
 ISO9001-2015  
 CERTIFIED

# Full-Band Internal Active High-Precision GNSS Antenna



**APXG6413GH-0600A**

Request Samples



Check Inventory



**64 x 64 x 13.4 mm**  
**RoHS/RoHS II Compliant**  
 MSL Level = N/A

## Electrical Specification

Parameters	Typ.	Units	Note
<b>Antenna</b>			
Frequency	GPS: L1/L2/L5 GLONASS: G1/G2/G3 Galileo: E1/E5a/E5b/E6 Beidou: B1/B2/B3 QZSS: L1/L2/L5/L6 IRNSS/NAVIC: L5 SBAS: L1/E1/B1 L5/B2a/E5a L band correction service		
Polarization	RHCP	-	(Right Hand Circular Polarization)
Nominal Impedance	50	$\Omega$	
Gain RHCP (maximum)	4.7	dBic (@Zenith)	1565–1585 MHz (L1)
	4.6		1212-1242MHz (L2)
	1.0		1166-1186MHz (L5)
	1.9		1257-1299MHz (L6)
Axial Ratio	$\leq 3$	dB	
Group delay variation	$\leq 5$	ns	
<b>LNA</b>			
Noise Figure	$\leq 2$	dB	
Gain	$33 \pm 2$	dB	
Output VSWR	$\leq 2.0$	-	
Operating Voltage	+3 to 5	V	
Current Consumption	$\leq 50$	mA	

The test data is based on a 120mm ground plane.



5101 Hidden Creek Ln Spicewood TX 78669  
 Phone: 512-371-6159 | Fax: 512-351-8858  
 For terms and conditions of sales, please visit:  
[www.abracon.com](http://www.abracon.com)

REVISED: 04-26-23

ABRACON IS  
 ISO9001-2015  
 CERTIFIED



**APXG6413GH-0600A**

Request Samples



Check Inventory



**64 x 64 x 13.4 mm**  
**RoHS/RoHS II Compliant**  
 MSL Level = N/A

## Mechanical Specifications

Parameter	Specification
Antenna Dimension	64 x 64 x 13.4 mm
Weight	≤ 90g
Mounting Type	Embedded Screw mount (4 x M2.5), adhesive available
RF Connector	MMCX-JW

## Environmental Specification

Parameter	Specification
Operating Temperature	-40°C to +85°C
Storage Temperature	-55°C to +85°C
RoHS Compliance	Yes
Relative Humidity	Up to 95%

# Full-Band Internal Active High-Precision GNSS Antenna



**APXG6413GH-0600A**

Request Samples



Check Inventory



**64 x 64 x 13.4 mm**  
**RoHS/RoHS II Compliant**  
MSL Level = N/A

## Product Dimension

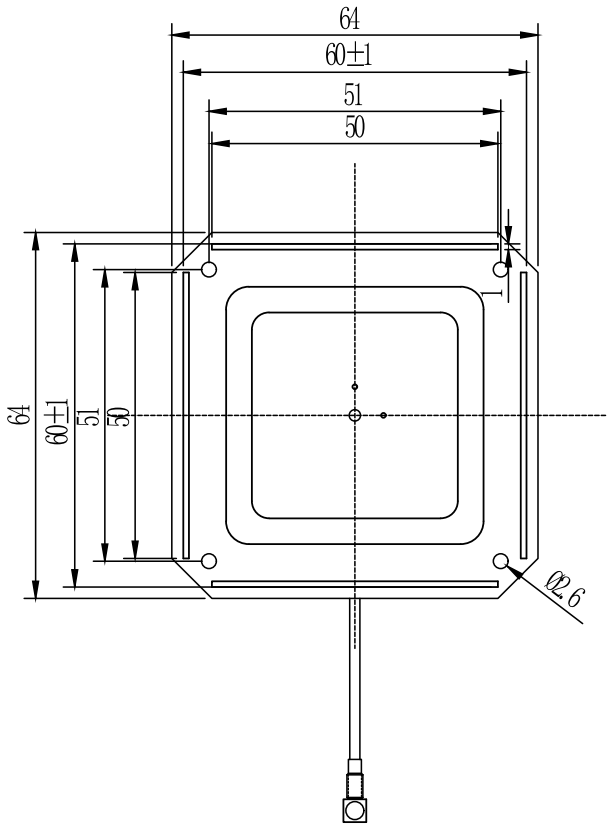

TOP VIEW

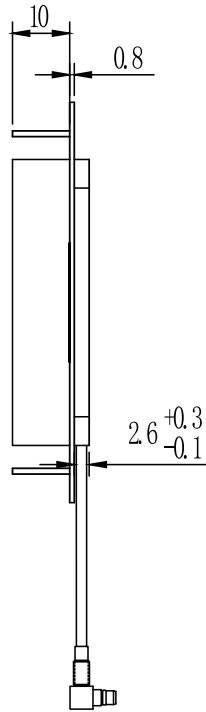

SIDE VIEW

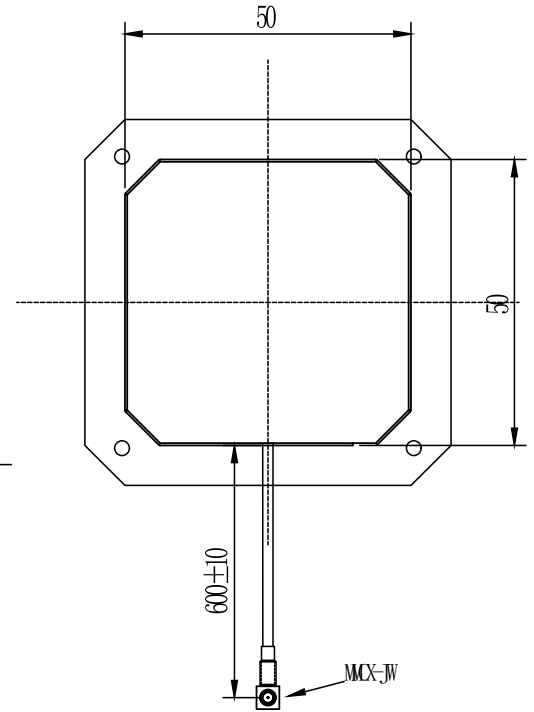

BOTTOM VIEW

Unit : mm



5101 Hidden Creek Ln Spicewood TX 78669  
Phone: 512-371-6159 | Fax: 512-351-8858  
For terms and conditions of sales, please visit:  
[www.abracon.com](http://www.abracon.com)

REVISED: 04-26-23

ABRACON IS  
ISO9001-2015  
CERTIFIED



**APXG6413GH-0600A**

Request Samples



Check Inventory



**64 x 64 x 13.4 mm**  
**RoHS/RoHS II Compliant**  
MSL Level = N/A

## Test Measurement – S-Parameter Characteristics

LNA output VSWR:

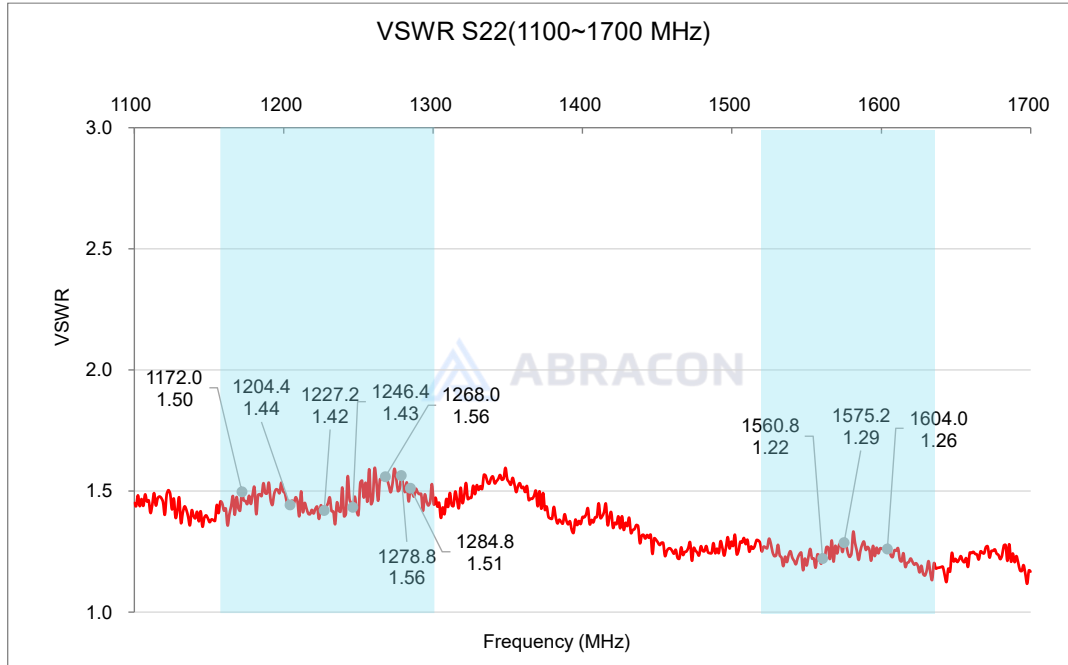

# Full-Band Internal Active High-Precision GNSS Antenna



**APXG6413GH-0600A**

Request Samples



Check Inventory



64 x 64 x 13.4 mm  
RoHS/RoHS II Compliant  
MSL Level = N/A

## Antenna Gain Test – Chamber Setup

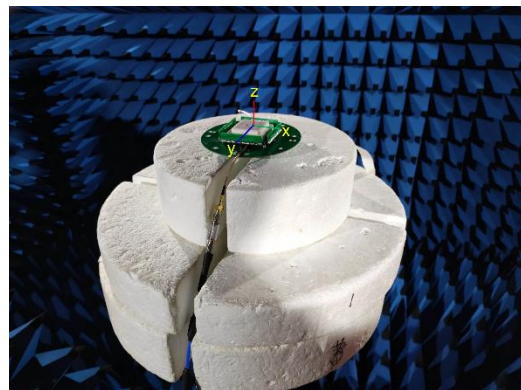
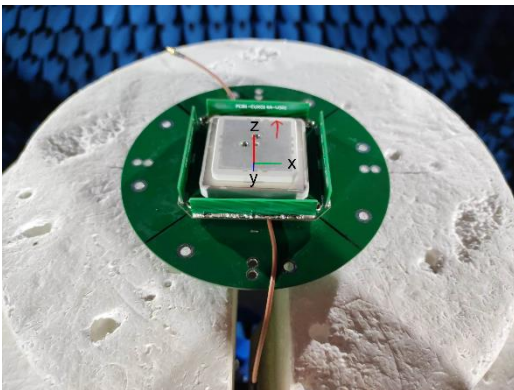
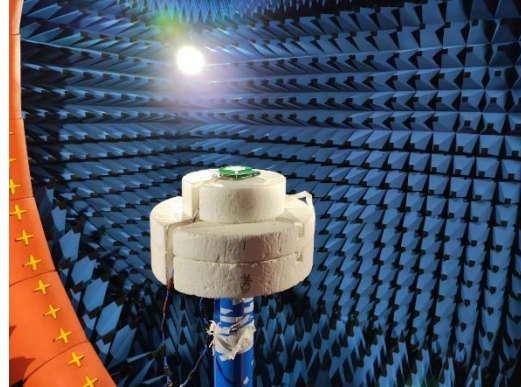
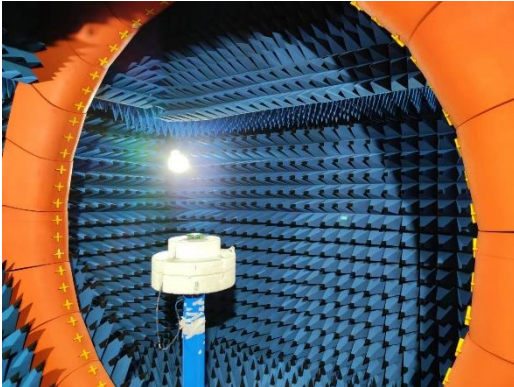

# Full-Band Internal Active High-Precision GNSS Antenna



**APXG6413GH-0600A**

Request Samples



Check Inventory



**64 x 64 x 13.4 mm**  
**RoHS/RoHS II Compliant**  
MSL Level = N/A

## Radiation Characteristics –Passive Gain

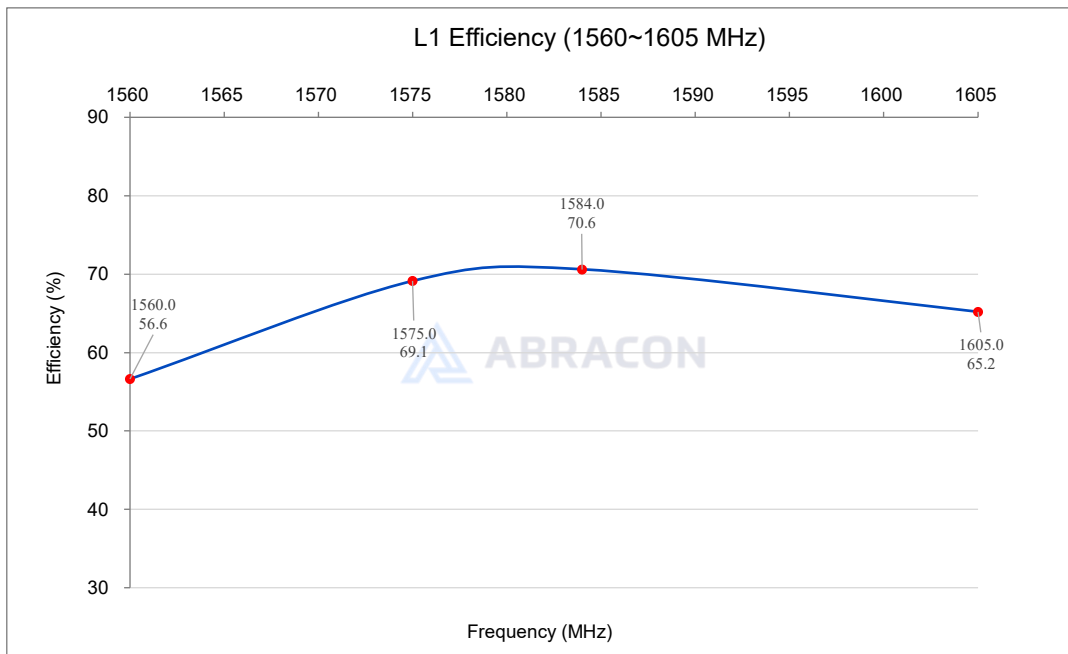
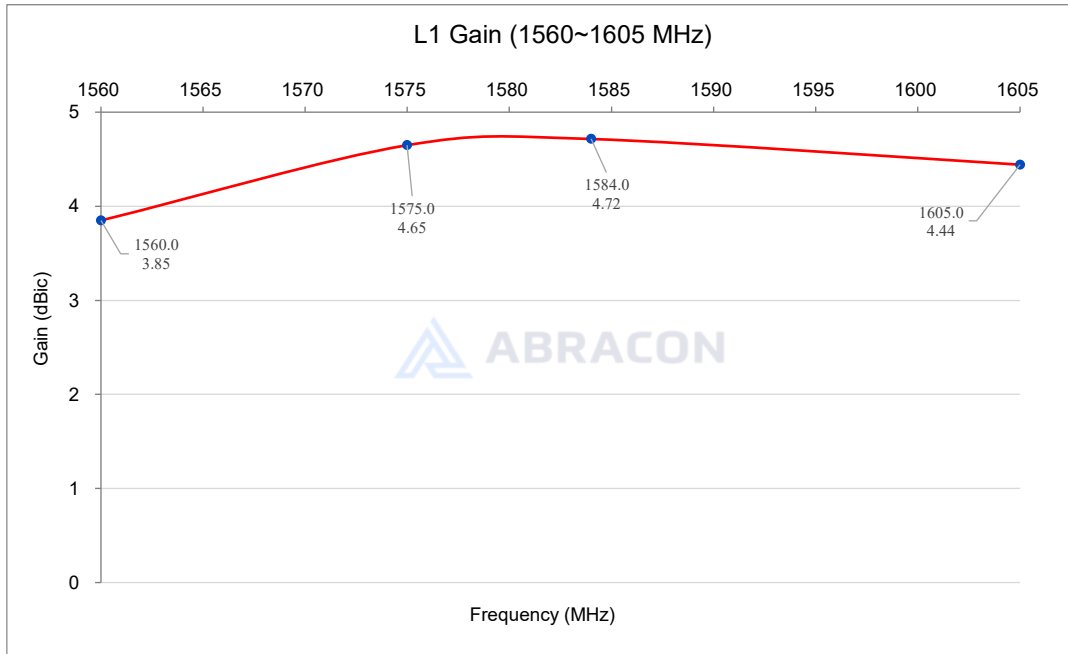

5101 Hidden Creek Ln Spicewood TX 78669  
Phone: 512-371-6159 | Fax: 512-351-8858  
For terms and conditions of sales, please visit:  
[www.abracon.com](http://www.abracon.com)

**REVISED: 04-26-23**

ABRACON IS  
ISO9001-2015  
CERTIFIED



# Full-Band Internal Active High-Precision GNSS Antenna



**APXG6413GH-0600A**

Request Samples



Check Inventory



**64 x 64 x 13.4 mm**  
**RoHS/RoHS II Compliant**  
**MSL Level = N/A**

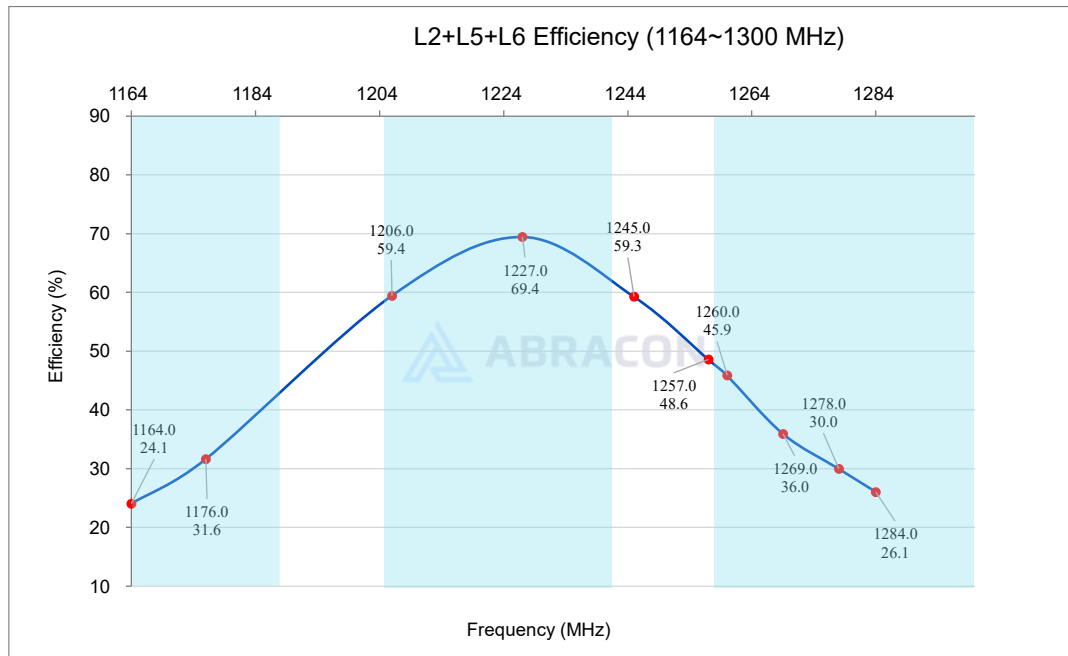
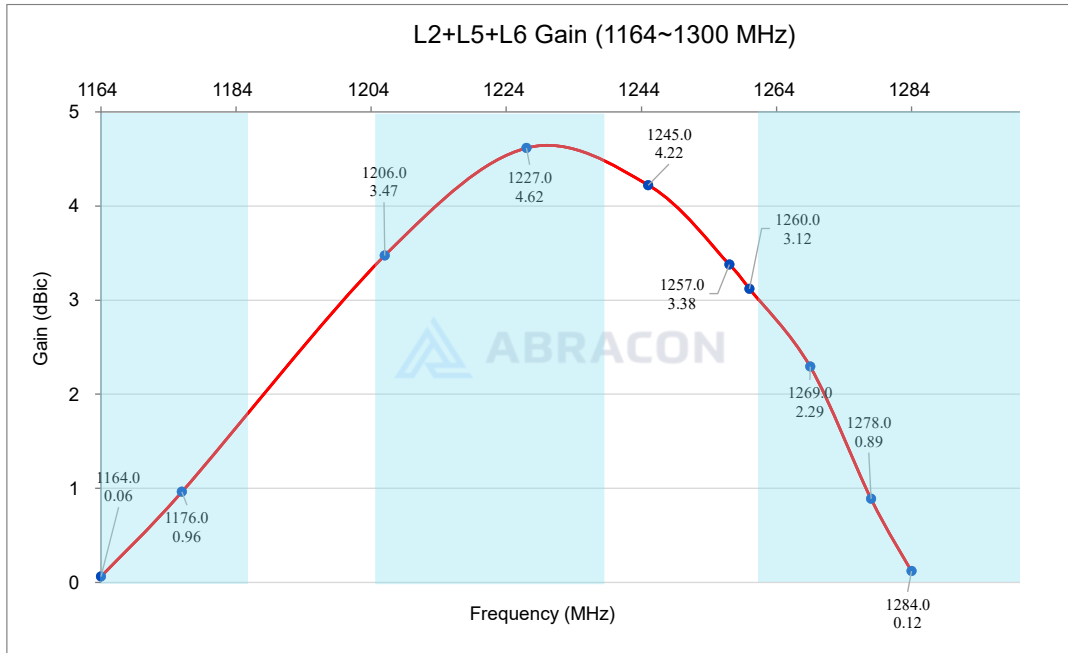

5101 Hidden Creek Ln Spicewood TX 78669  
 Phone: 512-371-6159 | Fax: 512-351-8858  
 For terms and conditions of sales, please visit:  
[www.abracon.com](http://www.abracon.com)

**REVISED: 04-26-23**

ABRACON IS  
 ISO9001-2015  
 CERTIFIED

# Full-Band Internal Active High-Precision GNSS Antenna



**APXG6413GH-0600A**

Request Samples



Check Inventory



**64 x 64 x 13.4 mm**  
**RoHS/RoHS II Compliant**  
 MSL Level = N/A

## L1 Band

Frequency (MHz)	Axial ratio (dB)	Gain (dBic)	Efficiency (%)
1560	0.64	3.85	56.62
1575	0.65	4.65	69.12
1584	0.53	4.72	70.61
1605	0.08	4.44	65.19

The test data is based on a 120mm ground plane.

## L2+L5+L6 Band

Frequency (MHz)	Axial ratio (dB)	Gain (dBic)	Efficiency (%)
1164	0.23	0.06	24.06
1176	0.47	0.96	31.64
1206	1.10	3.47	59.44
1227	1.29	4.62	69.44
1245	1.27	4.22	59.27
1257	1.25	3.38	48.58
1260	1.25	3.12	45.88
1269	1.23	2.29	35.96
1278	1.21	0.89	30.00
1284	1.19	0.12	26.06

The test data is based on a 120mm ground plane.

# Full-Band Internal Active High-Precision GNSS Antenna



**APXG6413GH-0600A**

Request Samples



Check Inventory



**64 x 64 x 13.4 mm**  
**RoHS/RoHS II Compliant**  
**MSL Level = N/A**

## Test Measurement – 2D radiation pattern

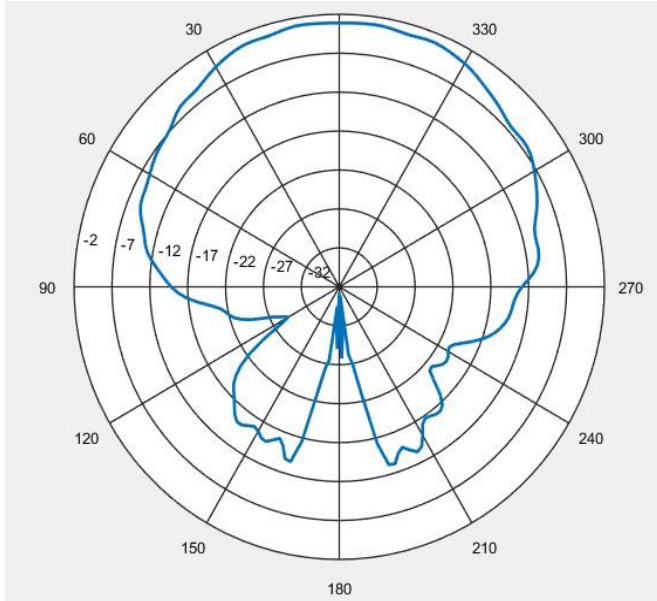

1164MHz

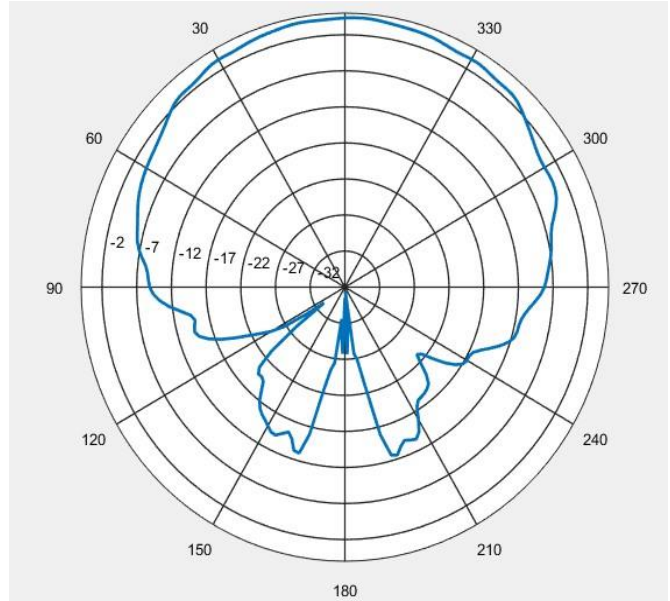

1176MHz

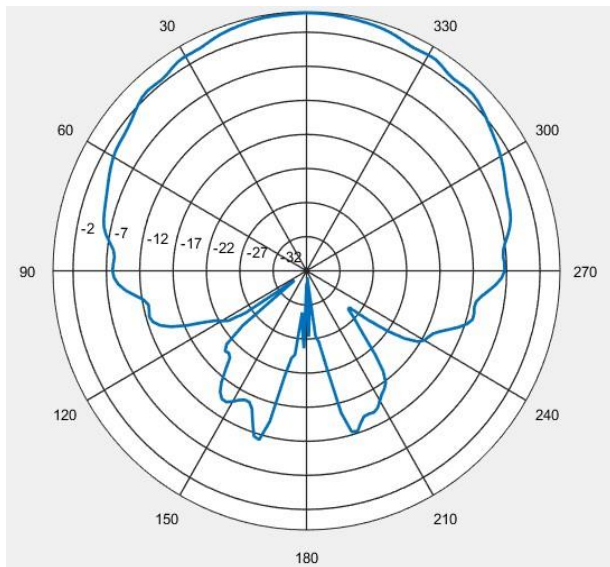

1207MHz

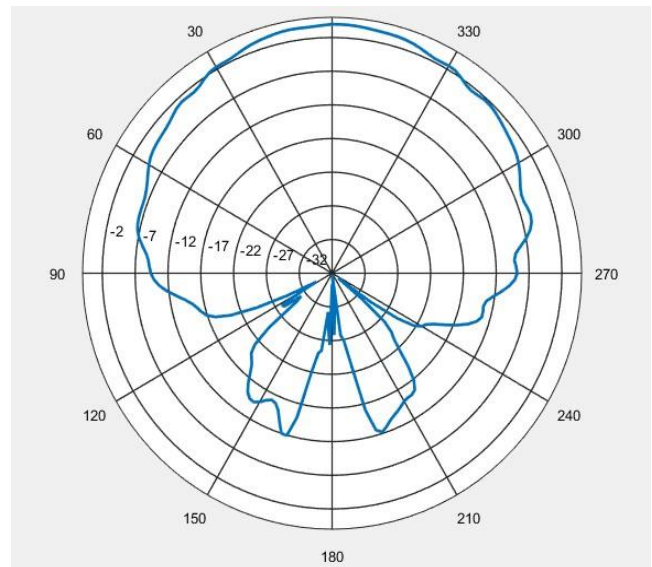

1227MHz



5101 Hidden Creek Ln Spicewood TX 78669  
Phone: 512-371-6159 | Fax: 512-351-8858  
For terms and conditions of sales, please visit:  
[www.abracon.com](http://www.abracon.com)

REVISED: 04-26-23

ABRACON IS  
ISO9001-2015  
CERTIFIED

# Full-Band Internal Active High-Precision GNSS Antenna



**APXG6413GH-0600A**

Request Samples



Check Inventory



**64 x 64 x 13.4 mm**  
**RoHS/RoHS II Compliant**  
**MSL Level = N/A**

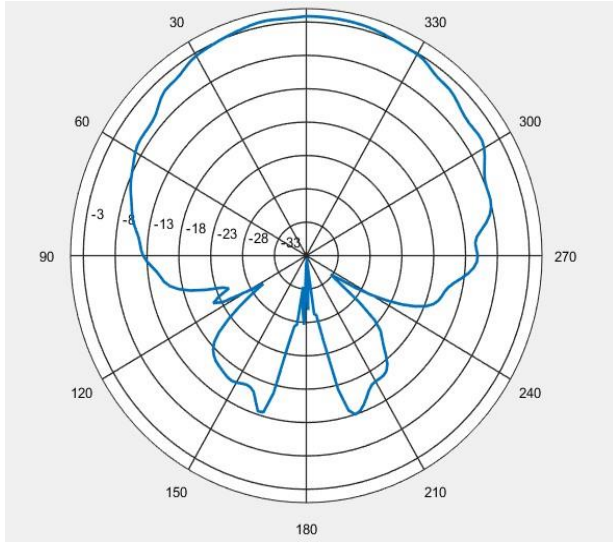

1246MHz

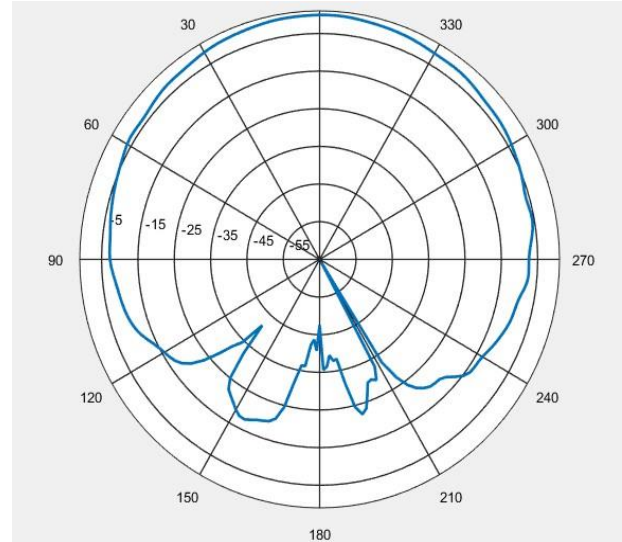

1258MHz

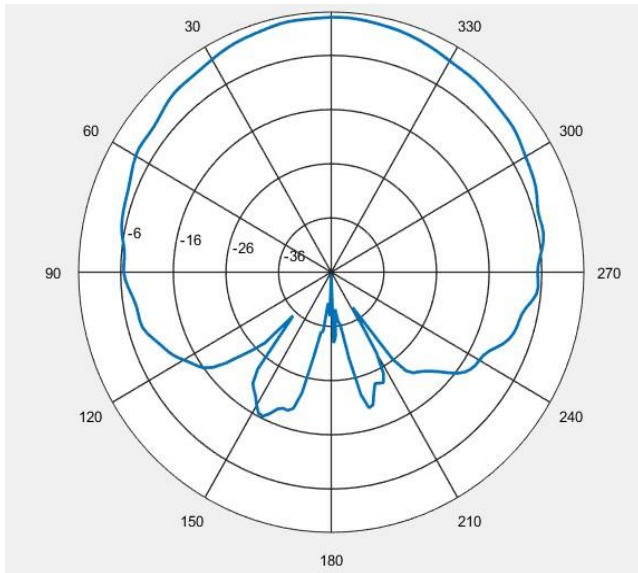

1561MHz

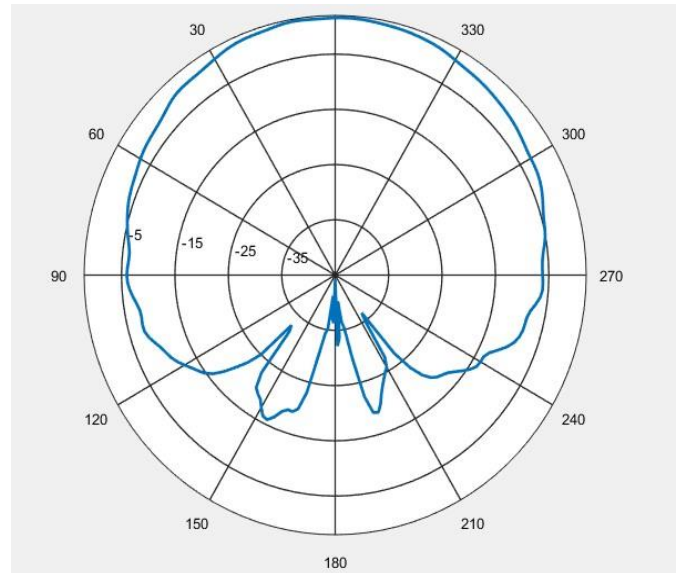

1575MHz



5101 Hidden Creek Ln Spicewood TX 78669  
Phone: 512-371-6159 | Fax: 512-351-8858  
For terms and conditions of sales, please visit:  
[www.abracon.com](http://www.abracon.com)

**REVISED: 04-26-23**

ABRACON IS  
ISO9001-2015  
CERTIFIED



**APXG6413GH-0600A**

Request Samples



Check Inventory



**64 x 64 x 13.4 mm**  
**RoHS/RoHS II Compliant**  
**MSL Level = N/A**

## Test Measurement – LNA Gain and Noise Figure

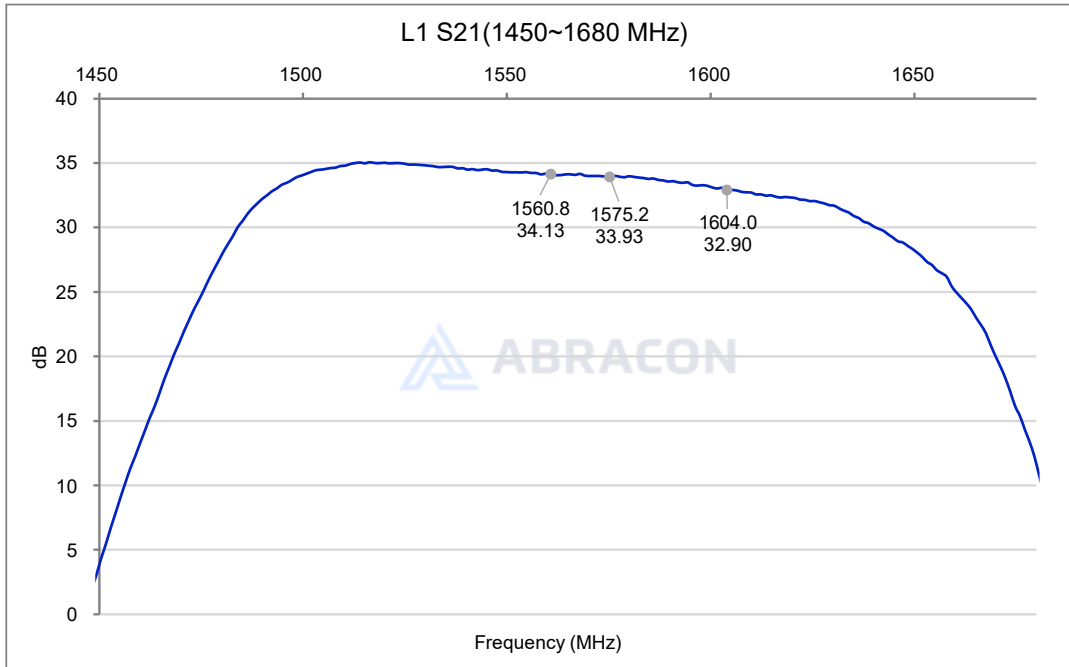

LNA gain (Band L1)

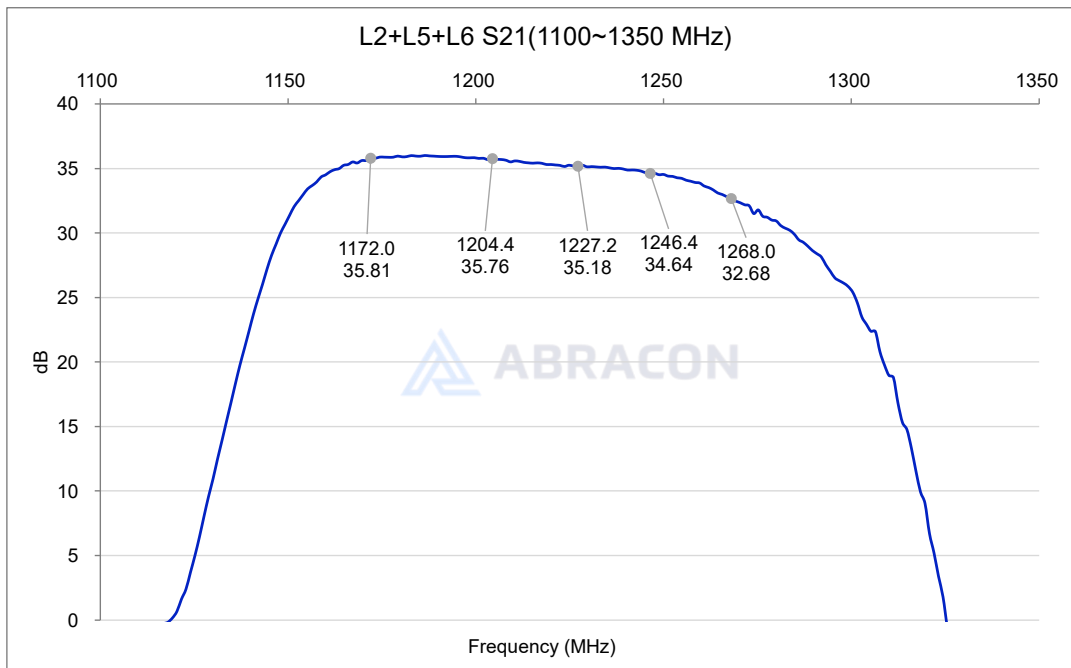

LNA gain (Band L2+L5+L6)

# Full-Band Internal Active High-Precision GNSS Antenna



**APXG6413GH-0600A**

Request Samples



Check Inventory



**64 x 64 x 13.4 mm**  
**RoHS/RoHS II Compliant**  
**MSL Level = N/A**

## Noise Figure

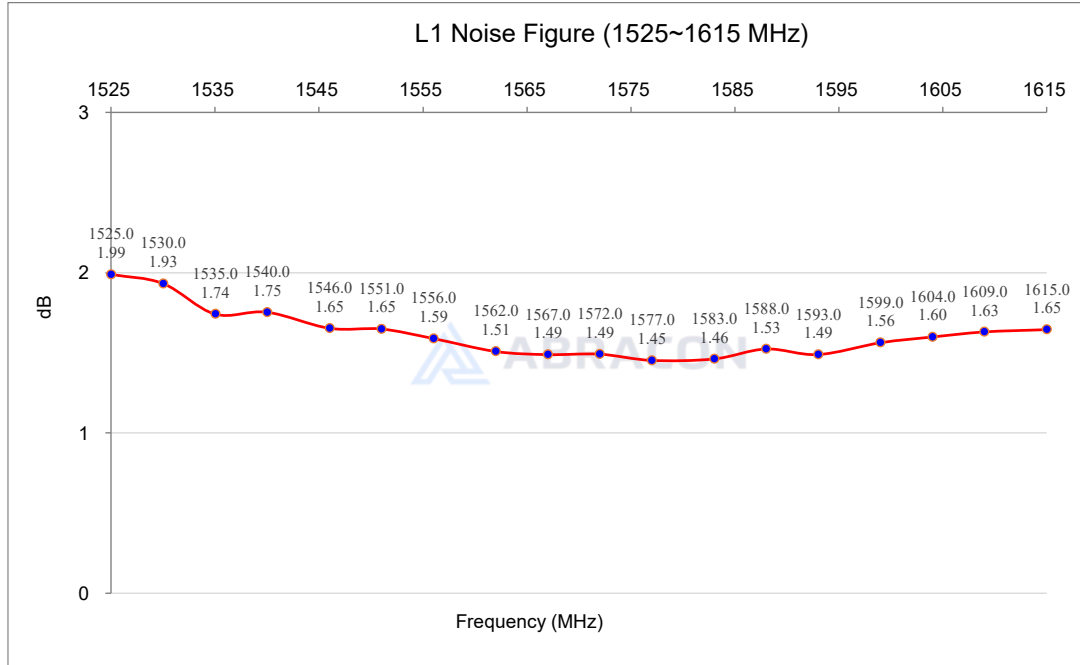

L1 Band

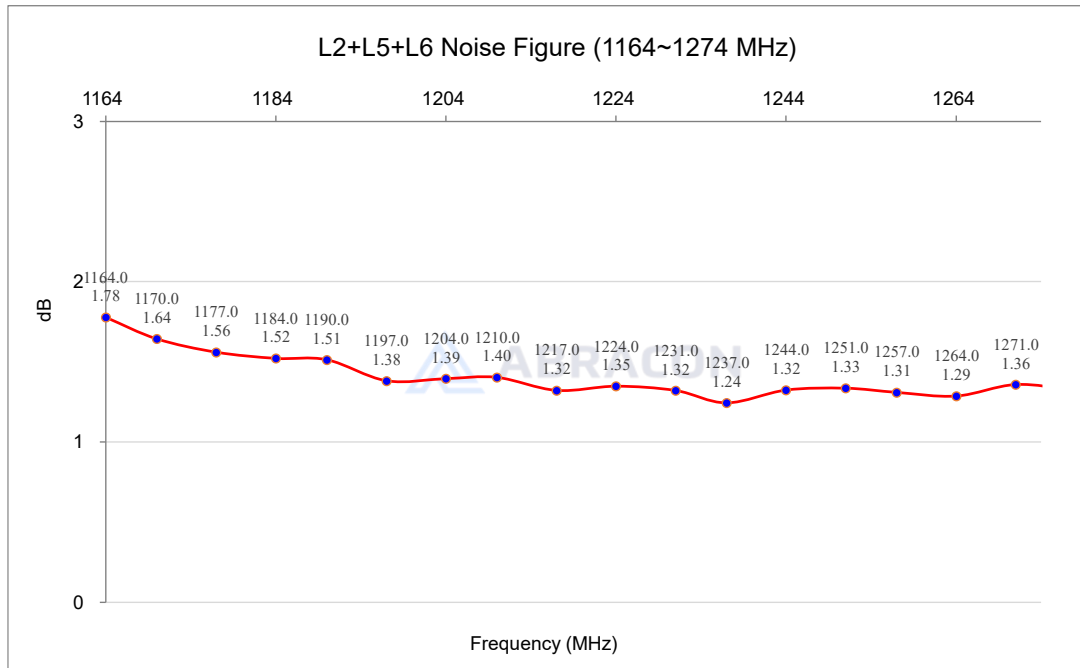

L2+L5+L6 Band



5101 Hidden Creek Ln Spicewood TX 78669  
 Phone: 512-371-6159 | Fax: 512-351-8858  
 For terms and conditions of sales, please visit:  
[www.abracon.com](http://www.abracon.com)

**REVISED: 04-26-23**

ABRACON IS  
 ISO9001-2015  
 CERTIFIED

# Full-Band Internal Active High-Precision GNSS Antenna



**APXG6413GH-0600A**

Request Samples



Check Inventory



64 x 64 x 13.4 mm  
RoHS/RoHS II Compliant  
MSL Level = N/A

## LNA Test Data

Frequency (MHz)	Circuit Gain (dB)	VSWR
1172	34.4	1.6
1204	34.5	1.6
1227	34.1	1.6
1246	33.7	1.6
1268	32.7	1.6
1561	34.2	1.2
1575	34.0	1.1
1604	33.1	1.1

The test data is based on a 120mm ground plane.

# Full-Band Internal Active High-Precision GNSS Antenna



**APXG6413GH-0600A**

Request Samples



Check Inventory



**64 x 64 x 13.4 mm**  
**RoHS/RoHS II Compliant**  
MSL Level = N/A

## Packaging Information

---

40pcs APXG6413GH antennas per tray

Dimensions: 610 x 560 x 100mm

120pcs APXG6413GH antennas per carton (3 trays)

Dimensions: L x W x H: 610 x 560 x 310mm

**ATTENTION:** Abracon LLC's products are COTS – Commercial-Off-The-Shelf products; suitable for Commercial, Industrial and, where designated, Automotive Applications. Abracon's products are not specifically designed for Military, Aviation, Aerospace, Life-dependent Medical applications or any application requiring high reliability where component failure could result in loss of life and/or property. For applications requiring high reliability and/or presenting an extreme operating environment, written consent and authorization from Abracon LLC is required. Please contact Abracon LLC for more information.



5101 Hidden Creek Ln Spicewood TX 78669  
Phone: 512-371-6159 | Fax: 512-351-8858  
For terms and conditions of sales, please visit:  
[www.abracon.com](http://www.abracon.com)

**REVISED: 04-26-23**

ABRACON IS  
ISO9001-2015  
CERTIFIED