



AN2I

Request Samples



Check Inventory



16 x 9 mm

RoHS/RoHS II Compliant

MSL Level = 1

Features

- Very Low Cost
- Low profile antenna integrated along PCB edge
- Robust performance even when employed in solutions requiring “potting/coating/over-mold”
- Patented Technology (License Agreement)
- Highly efficient > -1.5 dB (71%)
- Low Return Loss: < -6.4 dB

Applications

- 863 - 928 MHz LPWA/LoRA/SigFox/ISM
- IoT, M2M
- Remote Monitoring/ Technology
- Smart metering
- Smart Home
- Wireless Remote Control
- Industrial/Commercial equipment
- Consumer Tracking

Product Image

The Niche antenna (triangular) is implemented on an evaluation board in the image below.





AN2I

Request Samples



Check Inventory



16 x 9 mm

RoHS/RoHS II Compliant

MSL Level = 1

Electrical Specification

Parameter	Specification	Unit
Operating Frequency	863 - 928	MHz
Return Loss	< -6.4	dB
Polarization	Linear	-
Peak Gain	3.7	dBi
Efficiency	> -1.5 (71)	dB (%)
Impedance	50	Ω

Note: All measurements were conducted on the evaluation board in free space. Performance will vary depending on the ground plane, application, and environment.

Mechanical Specification

Parameter	Specification
Antenna Dimension	16 x 9 mm
Evaluation board Dimension	120 x 50 mm
Mounting Type	N/A: The antenna is implemented in the customer layout design under license agreement

Product Dimensions

The triangular Niche antenna cutout is 16 by 9 mm in size, see dimensions in millimeters below.

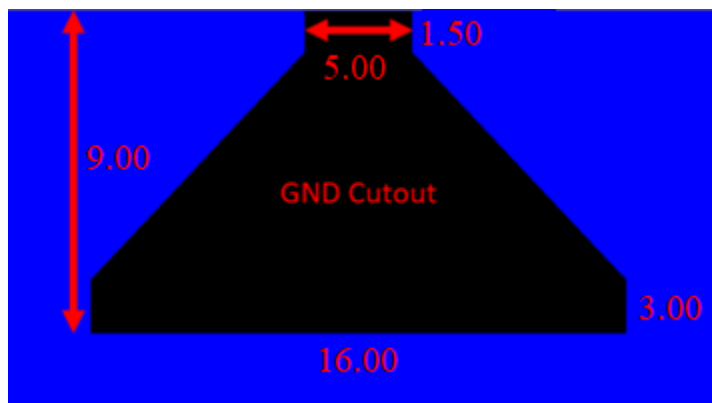
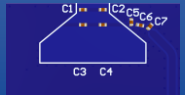

Image not to scale.

Licensing Information

The Niche concept is an Abracon patented technology that is sold through licensing. License agreement information, terms and conditions, and design advice are provided upon request. Please send all requests to niche@abracon.com



AN2I

Request Samples



Check Inventory



16 x 9 mm

RoHS/RoHS II Compliant

MSL Level = 1

Measurement Setup

The antenna measurements were all done in free space, with the Niche antenna implemented on its evaluation board that has a PCB size of 120 by 50 (X by Y) mm:

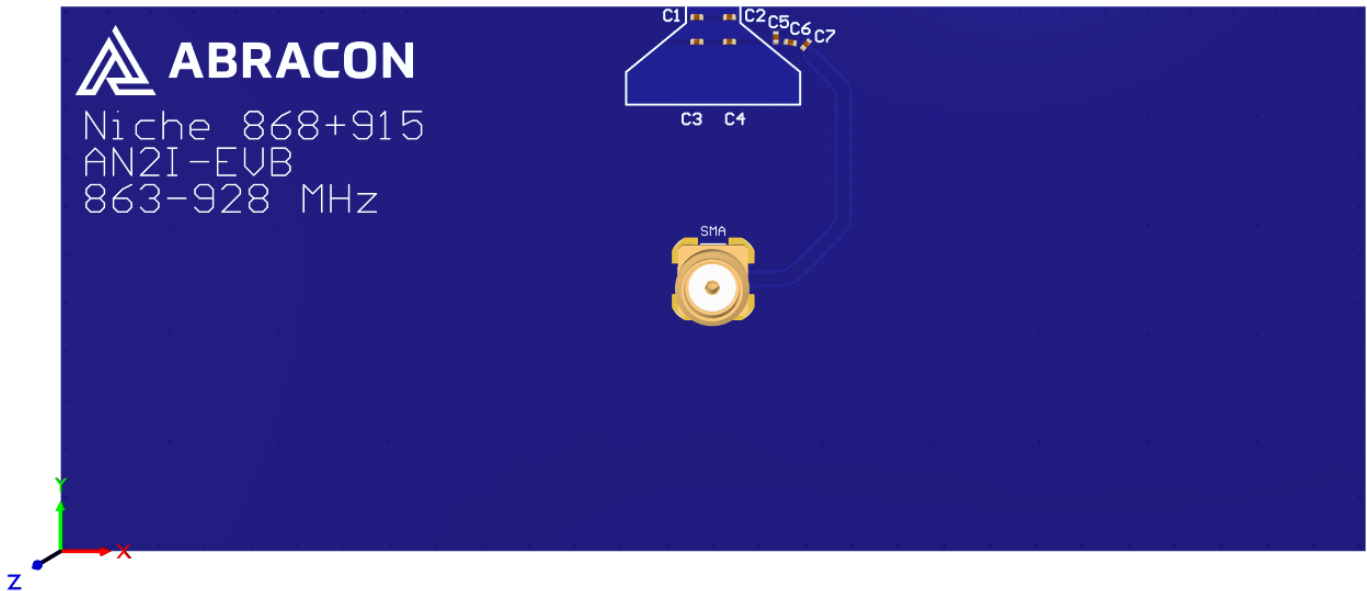

Reflection Characteristics – Return Loss

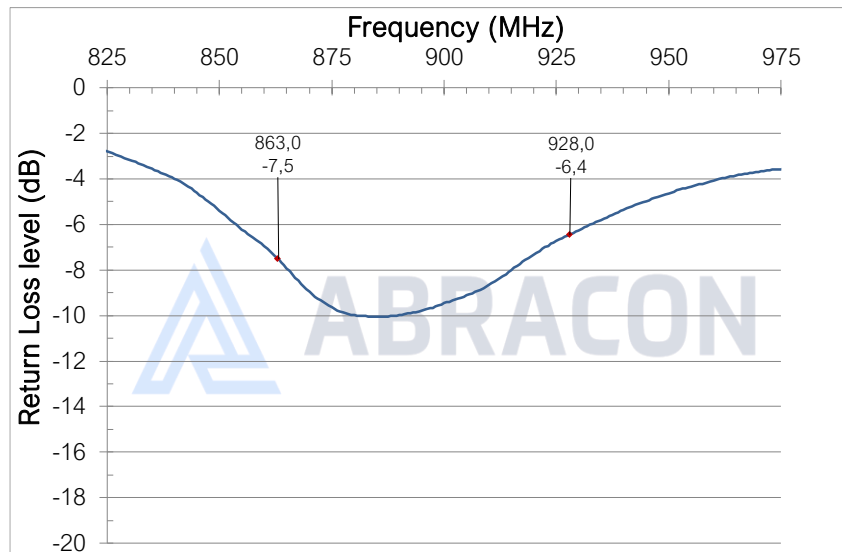



AN2I

Request Samples



Check Inventory



16 x 9 mm

RoHS/RoHS II Compliant

MSL Level = 1

Radiation Characteristics – Total Efficiency

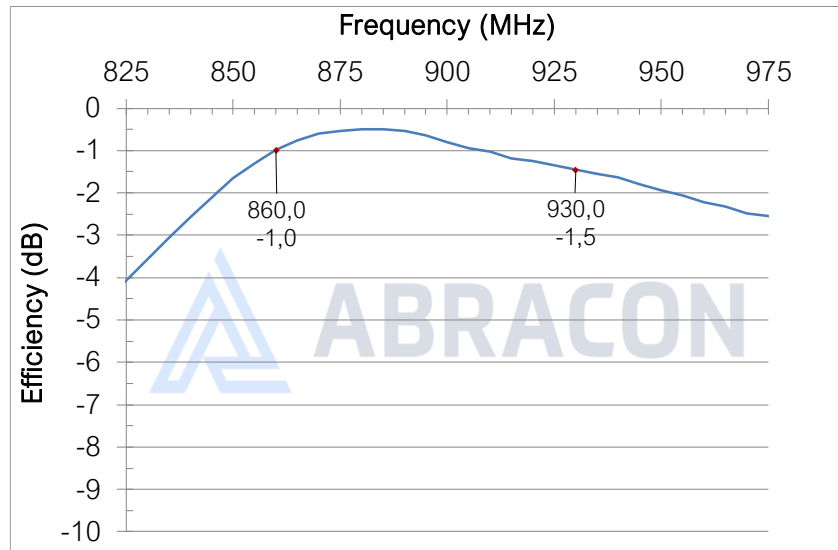

Radiation Characteristics – Maximum Gain

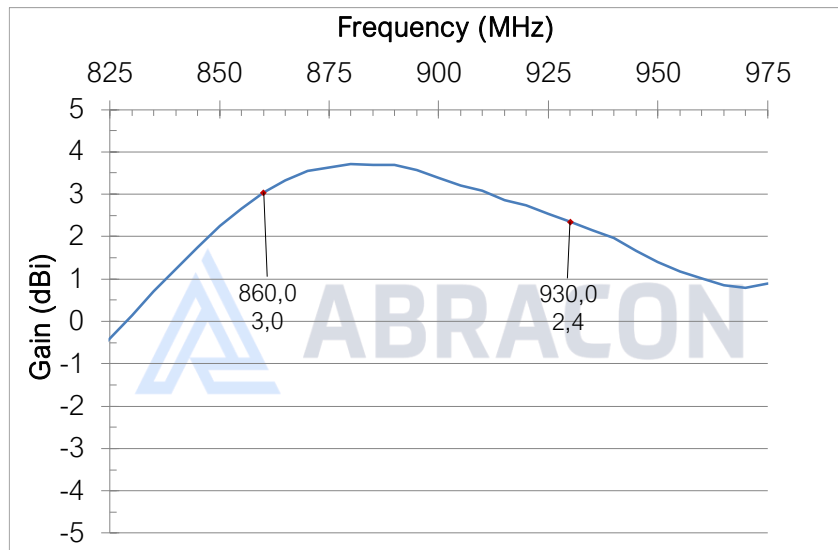



AN2I

Request Samples



Check Inventory



16 x 9 mm

RoHS/RoHS II Compliant

MSL Level = 1

Radiation Characteristics – 2D Pattern @ 870 MHz

XY-plane:

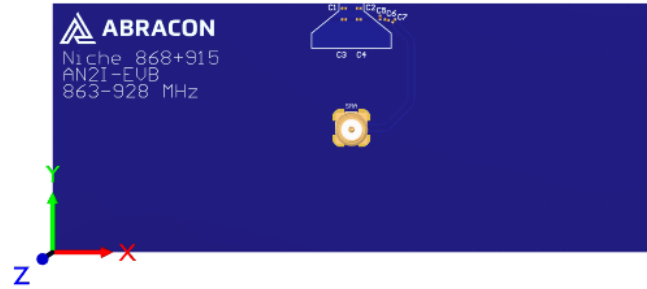
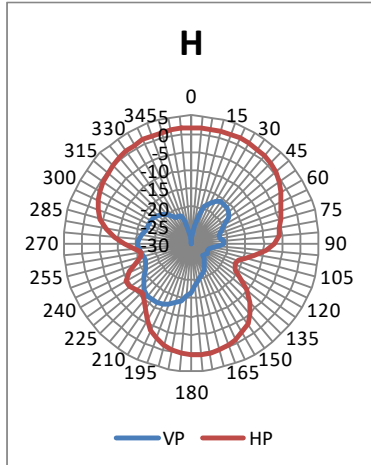

YZ-plane:

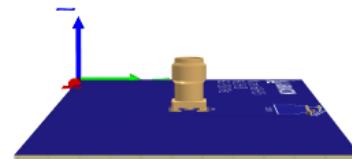
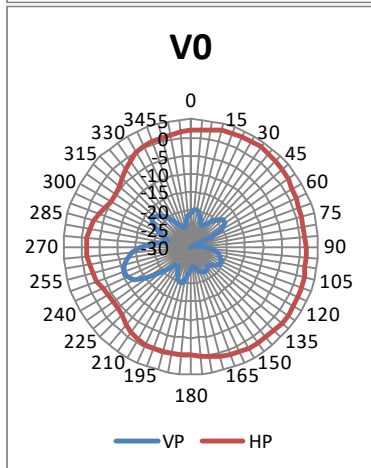

XZ-plane:

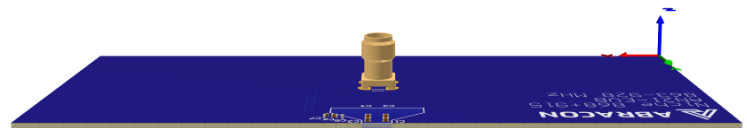
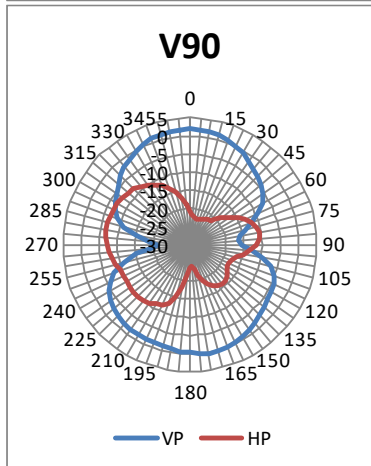

VP: Vertical Polarization
HP: Horizontal Polarization

Unit: dBi



AN2I

Request Samples



Check Inventory



16 x 9 mm

RoHS/RoHS II Compliant

MSL Level = 1

Radiation Characteristics – 2D Pattern @ 915 MHz

XY-plane:

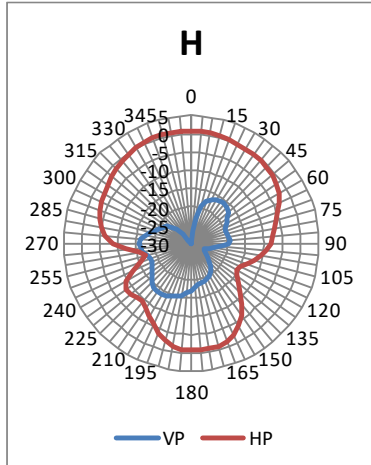

YZ-plane:

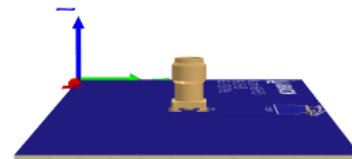
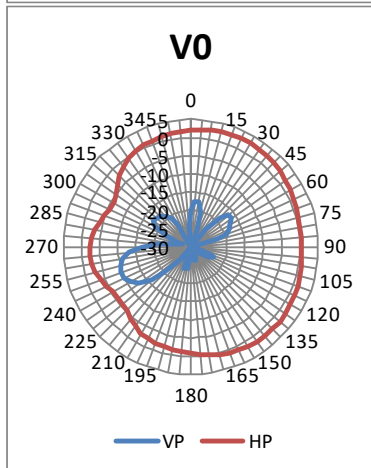

XZ-plane:

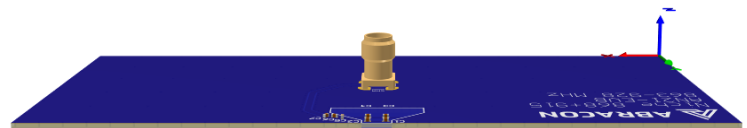
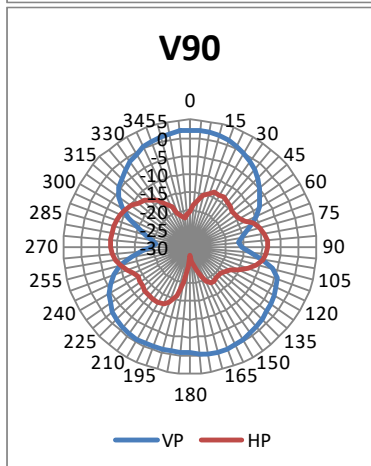

VP: Vertical Polarization
HP: Horizontal Polarization

Unit: dBi



AN2I

Request Samples



Check Inventory



16 x 9 mm

RoHS/RoHS II Compliant

MSL Level = 1

Evaluation Board Outline & Matching Circuit

The evaluation board is developed to showcase the performance of the Niche antenna on a typical PCB and to simplify antenna testing and evaluation. It has a size of 120 x 50 mm and includes an SMA connector. The performance will vary with different PCB sizes. Abracon can offer support to optimize the antenna for specific applications.

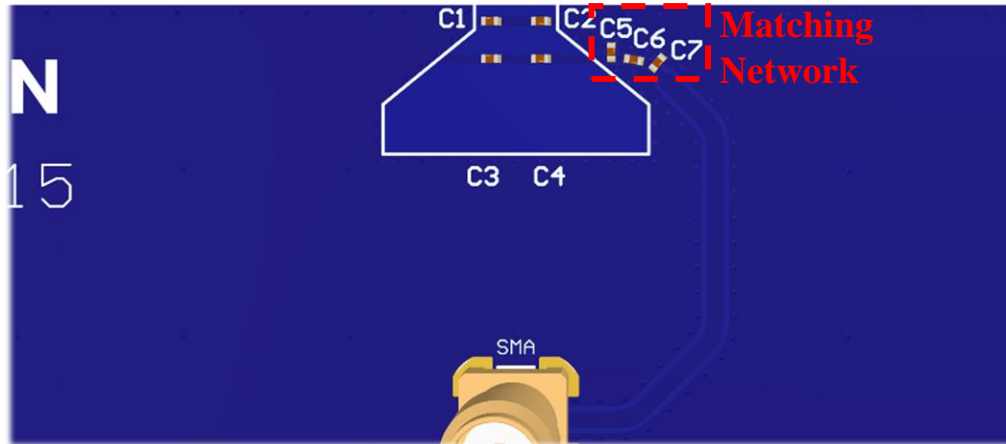

The evaluation board has a matching circuit implemented next to the antenna to enable optimization possibilities for the user. The component footprints are sized for 0402 (1005 metric) SMD components. Components C1-C4 are part of the antenna and will be disclosed upon design-in.

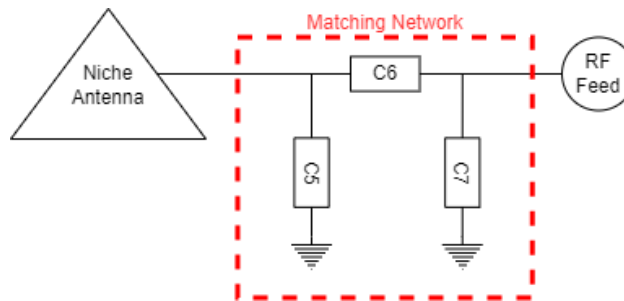

The standard tuning for the evaluation board is the following (can be replaced by equivalent):

- C5 = Not Mounted
- C6 = Zero Ohm (KOA Speer RK73Z1ETTP)
- C7 = Not Mounted

However, it is common that the resonant frequency will shift during implementation in an arbitrary device. Therefore, this matching may be changed with other values/components/brands for compensation of such effects. This is further described in the General Implementation Guidelines section below.



AN2I

Request Samples



Check Inventory



16 x 9 mm

RoHS/RoHS II Compliant

MSL Level = 1

General Implementation Guidelines for the Niche antenna

The antenna can be positioned in different ways, although there are some positions which are more beneficial. The left picture shows a typical PCB with examples on different antenna positions. The optimal position is option 1. Options 2 and 3 are also possible. The antenna must be placed along the PCB edge, i.e., it cannot be placed in the middle.

Antenna Positions:

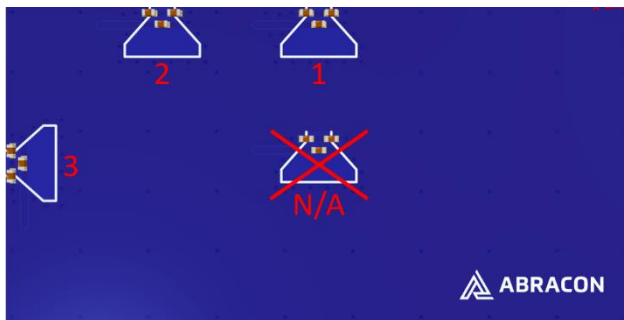

Triangular antenna cutout & via-structure:

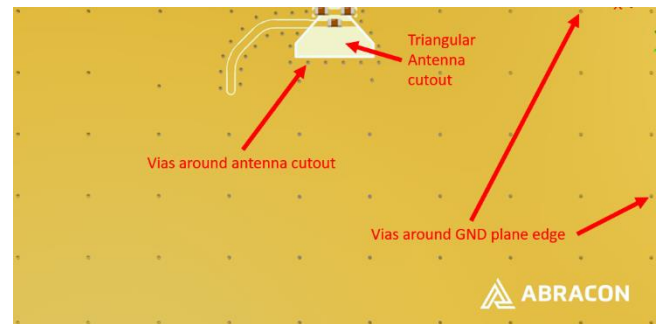

The triangular copper cutout needs to go through all the layers in the PCB stackup, meaning that there cannot be copper on any layer in this triangular area. It is also recommended to have a good via-structure around the antenna and the edge of the ground plane, see the right image above.

If other electrical components are positioned in the surrounding area of the antenna cutout, some impact on the antenna tuning and radiated performance may be expected. It is recommended that such components are distributed below a topographical slope that starts on PCB level at the antenna cutout, and slowly increases the height. In other words, small electrical components may be mounted close to the antenna if they do not enter the triangular copper cutout. This is a space-efficient solution which usually has low influence on the performance

It shall also be highlighted that plastic and metal parts in the near proximity of antennas may influence the antenna tuning and/or performance. This aspect should be noted as a general guideline for all antennas. The effects are difficult to estimate without detailed information, but it is common that a plastic housing above the antenna shifts the resonant frequency down. It is recommended to measure the antenna in the actual device after implementation and to implement a matching network on the antenna feed to adjust for the potential frequency shift.

The Niche antenna shows great performance when potted compared to other antenna solutions and has also shown good performance in proximity of metal and other harsh antenna environments.

ATTENTION: Abracon LLC's products are COTS – Commercial-Off-The-Shelf products; suitable for Commercial, Industrial and, where designated, Automotive Applications. Abracon's products are not specifically designed for Military, Aviation, Aerospace, Life-dependent Medical applications or any application requiring high reliability where component failure could result in loss of life and/or property. For applications requiring high reliability and/or presenting an extreme operating environment, written consent and authorization from Abracon LLC is required. Please contact Abracon LLC for more information.



5101 Hidden Creek Ln Spicewood TX 78669
 Phone: 512-371-6159 | Fax: 512-351-8858
 For terms and conditions of sales, please visit:
www.abracon.com

REVISED: 12-22-22

ABRACON IS
 ISO9001-2015
 CERTIFIED