

# Molded Inductor (Carbonyl)

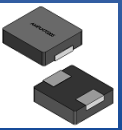

**AMPLH7025S**

Request Samples



Check Inventory



7.3 x 6.6 x 2.2 mm  
RoHS/RoHS II Compliant  
MSL Level = 1

## Features

- Shielded construction
- Soft saturation
- Low DCR, High Efficiency
- Designed for switching frequencies between 100KHz-2MHz

## Applications

- DC/DC Switching converters
- Power supplies for Notebooks, workstations, and Servers
- Low Profile applications
- High current, transient load applications

## Electrical Specifications

Part Number	Inductance	Tolerance	DC Resistance		Saturation Current	Temperature Rise Current
	0.1MHz/1.0V		Max.	Typ.	Typ.	Typ.
Units	$\mu\text{H}$	%	$\text{m}\Omega$		A	A
Symbol	L	M	DCR		Isat	Irms
AMPLH7025S-R20M	0.20	$\pm 20$	1.9	1.6	41.0	25.0
AMPLH7025S-R33M	0.33	$\pm 20$	2.4	2.0	33.0	21.0
AMPLH7025S-R47M	0.47	$\pm 20$	4.2	3.6	27.0	19.0
AMPLH7025S-R68M	0.68	$\pm 20$	4.6	4.0	23.0	17.0
AMPLH7025S-1R0M	1.00	$\pm 20$	6.8	5.9	17.0	15.0
AMPLH7025S-1R5M	1.50	$\pm 20$	10.1	8.7	15.0	13.0
AMPLH7025S-2R2M	2.20	$\pm 20$	14.7	12.8	12.0	10.0
AMPLH7025S-3R3M	3.30	$\pm 20$	27.6	24.0	9.0	8.0
AMPLH7025S-4R7M	4.70	$\pm 20$	36.8	32.0	8.0	7.0
AMPLH7025S-5R6M	5.60	$\pm 20$	40.2	35.0	7.5	6.5
AMPLH7025S-6R8M	6.80	$\pm 20$	50.6	44.0	7.0	6.0
AMPLH7025S-8R2M	8.20	$\pm 20$	53.0	46.0	6.0	5.5
AMPLH7025S-100M	10.00	$\pm 20$	73.6	64.0	5.5	5.0

## Test Conditions

**Isat:** DC current at which the inductance drops 30% from its initial value.

**Irms:** DC current that causes the temperature rise ( $\Delta T$ , approximate 40°C) from 25°C ambient.

**Operating Temperature:** -40°C ~ +125°C (including self-temperature rise)

**Storage Condition:** -40°C ~ +125°C (on board), -10°C ~ +40°C (with packaging) and R.H. 85% max.

**Operating Voltage:** 50V (across inductor)

**AMPLH7025S Series is RoHS Compliant and Pb free.**

**For saturation and temperature rise graphs, please visit [Abracon | Power Inductor Performance Analyzer \(PIPA\)](#)**



5101 Hidden Creek Ln, Spicewood TX 78669  
Phone: 512-371-6159 Fax: 512-351-8858  
For terms and conditions of sales, please visit:  
[www.abracon.com](http://www.abracon.com)

**REVISION Initial Release :**  
2/28/2024

ABRACON IS  
ISO9001-2015  
CERTIFIED

# Molded Inductor (Carbonyl)

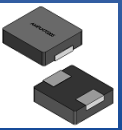

AMPLH7025S

Request Samples



Check Inventory



7.3 x 6.6 x 2.2 mm  
RoHS/RoHS II Compliant  
MSL Level = 1

## Part Identification

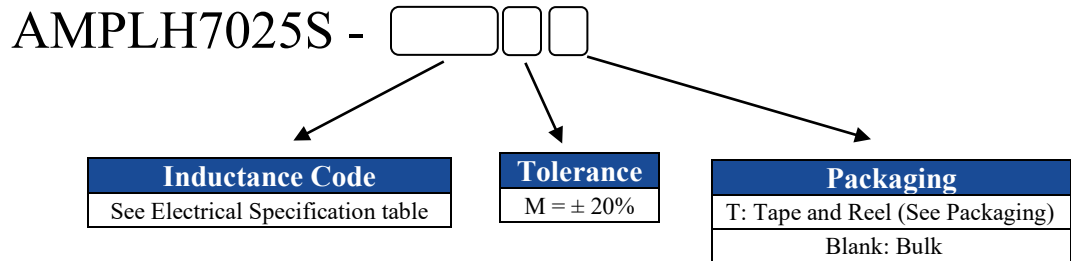

## Marking

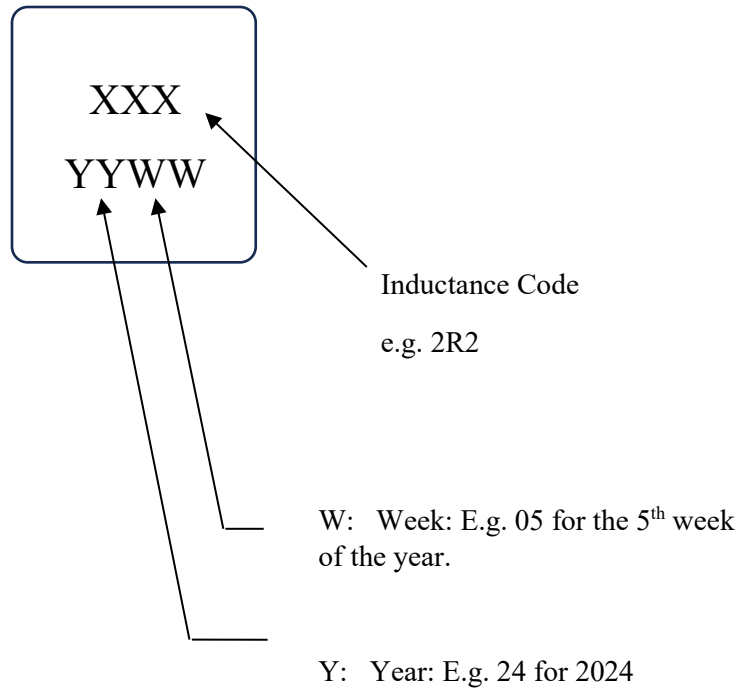

Marking Method = Ink Marking



5101 Hidden Creek Ln, Spicewood TX 78669  
Phone: 512-371-6159 Fax: 512-351-8858  
For terms and conditions of sales, please visit:  
[www.abracon.com](http://www.abracon.com)

REVISION Initial Release :  
2/28/2024

ABRACON IS  
ISO9001-2015  
CERTIFIED

# Molded Inductor (Carbonyl)

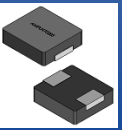

**AMPLH7025S**

Request Samples



Check Inventory



**7.3 x 6.6 x 2.2 mm**  
**RoHS/RoHS II Compliant**  
**MSL Level = 1**

## Mechanical Specifications

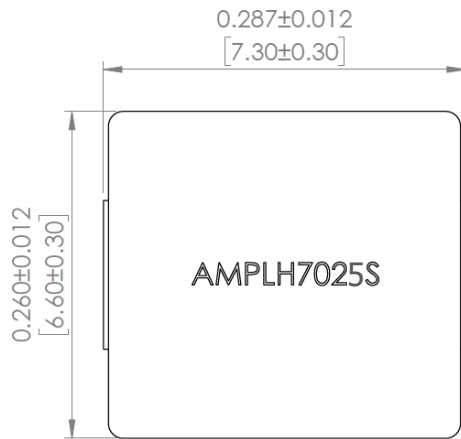

**TOP VIEW**

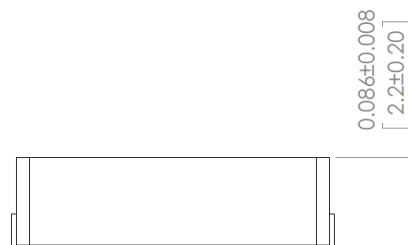

**FRONT VIEW**

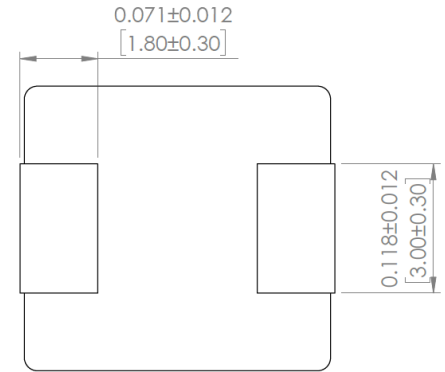

**BOTTOM VIEW**

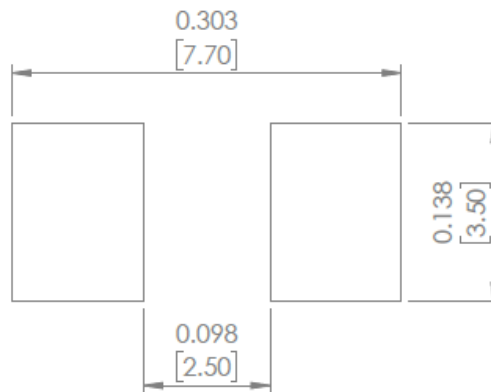

**RECOMMENDED LAND PATTERN**

Dimensions: Inches [mm]



5101 Hidden Creek Ln, Spicewood TX 78669  
Phone: 512-371-6159 Fax: 512-351-8858  
For terms and conditions of sales, please visit:  
[www.abracon.com](http://www.abracon.com)

**REVISION Initial Release :**  
**2/28/2024**

ABRACON IS  
ISO9001-2015  
CERTIFIED

# Molded Inductor (Carbonyl)



AMPLH7025S

Request Samples



Check Inventory



7.3 x 6.6 x 2.2 mm  
RoHS/RoHS II Compliant  
MSL Level = 1

## Materials

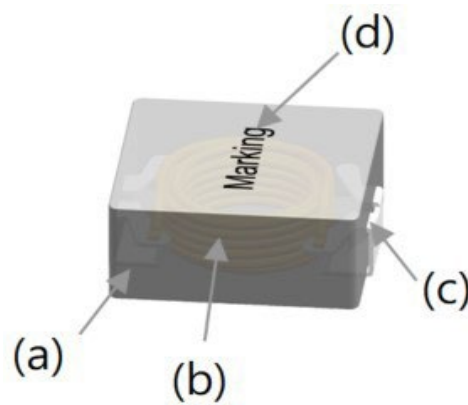

	Components	Material
a	Core	Alloy Powder
b	Wire	Polyester Wire
c	Electrode	Cu/Ni/Sn
d	Marking	Ink

# Molded Inductor (Carbonyl)

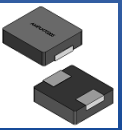

**AMPLH7025S**

Request Samples



Check Inventory



7.3 x 6.6 x 2.2 mm  
**RoHS/RoHS II Compliant**  
 MSL Level = 1

## Reflow Profile

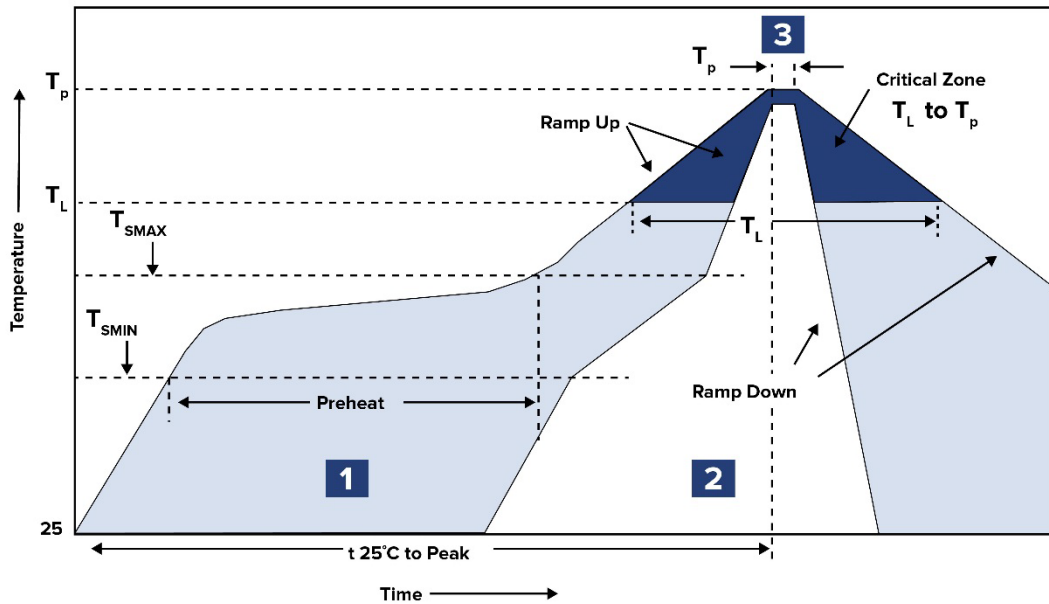

Zone	Description	Temperature	Times
1	Preheat	$T_{SMIN} \sim T_{SMAX}$ 150°C ~ 200°C	60 ~ 120 sec.
2	Reflow	$T_L$ $\geq 217^\circ\text{C}$	60 ~ 150 sec.
3	Peak heat	$T_p$ 260°C	30 sec. MAX

Time of 25°C to peak temperature: 8 mins Max  
 Ramp up rate: 3°C/Second max.  
 Ramp down rate: 6°C/Second max.

# Molded Inductor (Carbonyl)

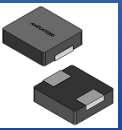

**AMPLH7025S**

Request Samples



Check Inventory



**7.3 x 6.6 x 2.2 mm**  
**RoHS/RoHS II Compliant**  
**MSL Level = 1**

## Packaging

**Tape & Reel: 1500 pcs/reel**

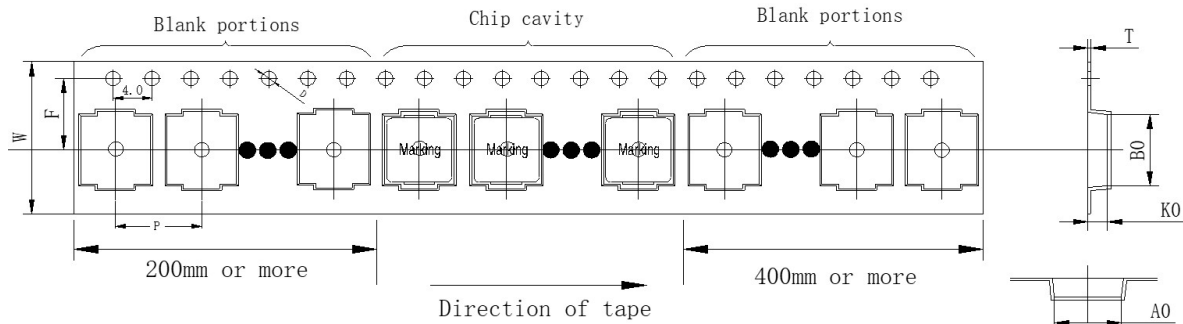

A0	B0	W	F	P	D	K0	T
7.10 Ref	8.10 Ref	16.00±0.30	7.50±0.10	12.00±0.10	1.50±0.10	2.70 Ref	0.35±0.05

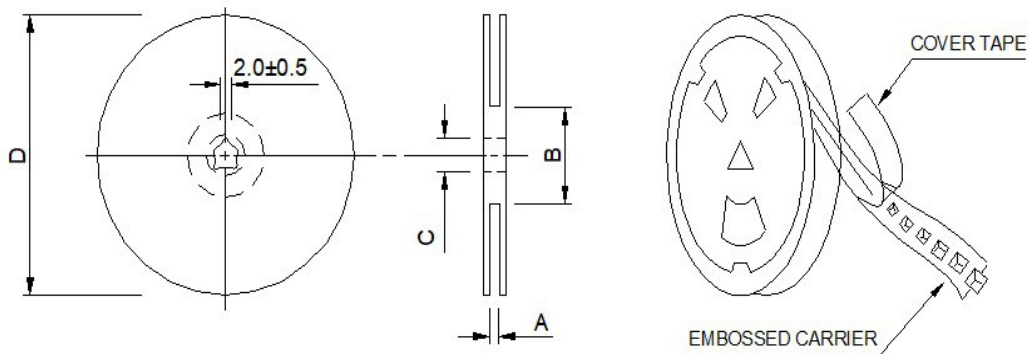

Type	A	B	C	D
13" x 16mm	16.4+2.0/-0.0	100.0±2.0	13.0+0.5/-0.2	330.0±0.3

**Dimensions: mm**

**ATTENTION:** Abracon LLC's products are COTS – Commercial-Off-The-Shelf products; suitable for Commercial, Industrial and, where designated, Automotive Applications. Abracon's products are not specifically designed for Military, Aviation, Aerospace, Life-dependent Medical applications or any application requiring high reliability where component failure could result in loss of life and/or property. For applications requiring high reliability and/or presenting an extreme operating environment, written consent and authorization from Abracon LLC is required. Please contact Abracon LLC for more information.



5101 Hidden Creek Ln, Spicewood TX 78669  
 Phone: 512-371-6159 Fax: 512-351-8858  
 For terms and conditions of sales, please visit:  
[www.abracon.com](http://www.abracon.com)

**REVISION Initial Release :**  
**2/28/2024**

ABRACON IS  
 ISO9001-2015  
 CERTIFIED