

4.5 – 6.0 GHz Low Noise Amplifier



ALND-WB-0011

Request Samples



Check Inventory



5.0 x 5.0 x 1.2 mm
RoHS Compliant

Features

- Frequency Range: 4.5 - 6.0 GHz
- 20 dB Nominal Gain
- Noise Figure: 1.7 dB (Typ)
- Input Return Loss: 8 dB (Typ)
- Output Return Loss: 15 dB (Typ)
- Output P1dB ~ 13 dBm @ 4V Operation.
- Self-bias 2V operation
- DC Decoupled Input and Output
- 32 Lead 5x5 mm QFN Package

Applications

- Electronic Warfare (EW)
- C Band Radar
- Phased Arrays
- Space
- Satellite Communications (Satcom)
- Test Equipment and Sensors

Product Image

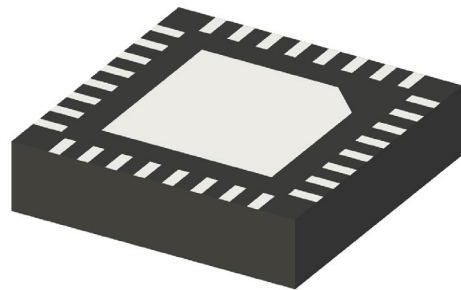
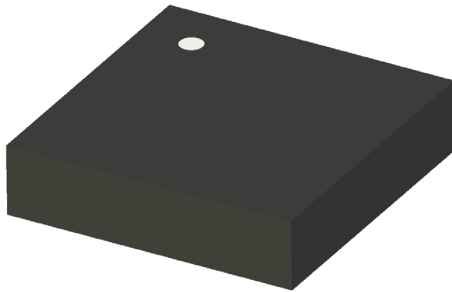

4.5 – 6.0 GHz Low Noise Amplifier



ALND-WB-0011

Request Samples



Check Inventory



5.0 x 5.0 x 1.2 mm
RoHS Compliant

Pin Configuration

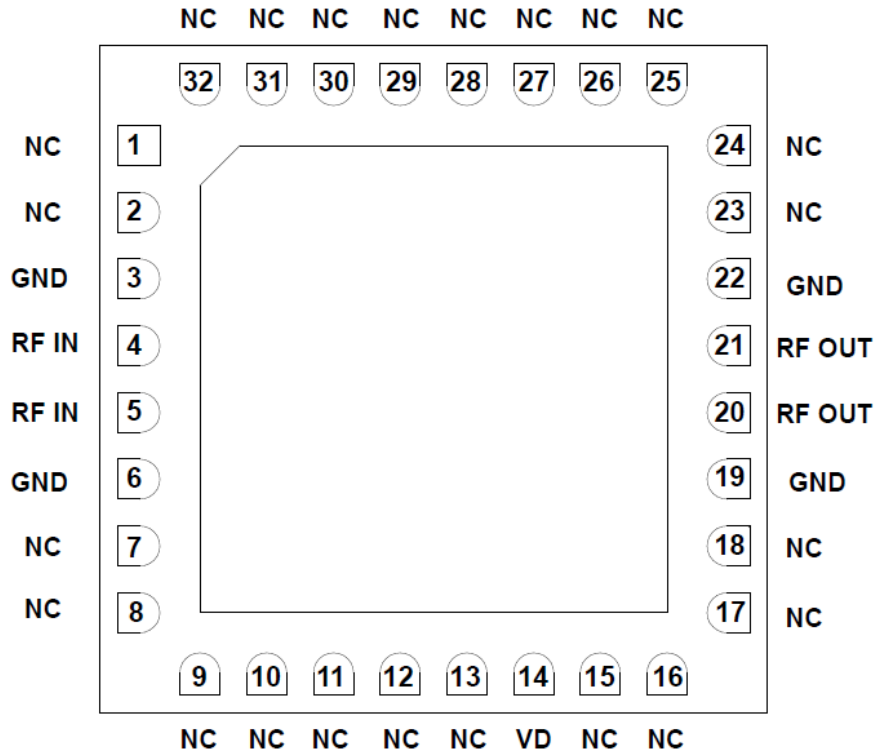

Absolute Maximum Ratings

Parameter	Absolute Maximum	Units
Positive DC voltage	+6	V
RF input power	+20	dBm
Supply Current	100	mA
Operating Temperature	-55 to +85	°C
Storage Temperature	-65 to +150	°C

1. Operation beyond these limits may cause permanent damage to the component.

4.5 – 6.0 GHz Low Noise Amplifier



ALND-WB-0011

Request Samples



Check Inventory



5.0 x 5.0 x 1.2 mm
RoHS Compliant

Electrical Specifications

Parameters Description	Unit	Minimum	Typical	Maximum
Frequency Range	GHz	4.5	-	6.0
Gain	dB	-	20	-
Gain Flatness	dB	-	±0.5	-
Noise Figure	dB	1.4	1.7	1.9
Input Return Loss	dB	6	8	-
Output Return Loss	dB	12	15	-
Output Power (P1 dB)	dBm	-	7/13	-
Supply Voltage	V	-	2	-
Supply Current	mA	-	40	-

@Ta = 25°C, Zo = 50Ω; Vd = +2V, Total Current = 40mA

NOTES:

1. Electrical specifications are measured in a test fixture.
2. 13 dBm P1dB can be achieved by operating drain supply voltage is at 4V @55 mA.

4.5 – 6.0 GHz Low Noise Amplifier



ALND-WB-0011

Request Samples



Check Inventory



5.0 x 5.0 x 1.2 mm
RoHS Compliant

Ordering Information

Part Number	Description
ALND-WB-0011	4.5 – 6.0 GHz Low Noise Amplifier Packing: Bulk

4.5 – 6.0 GHz Low Noise Amplifier



ALND-WB-0011

Request Samples



Check Inventory



5.0 x 5.0 x 1.2 mm
RoHS Compliant

Product Dimensions

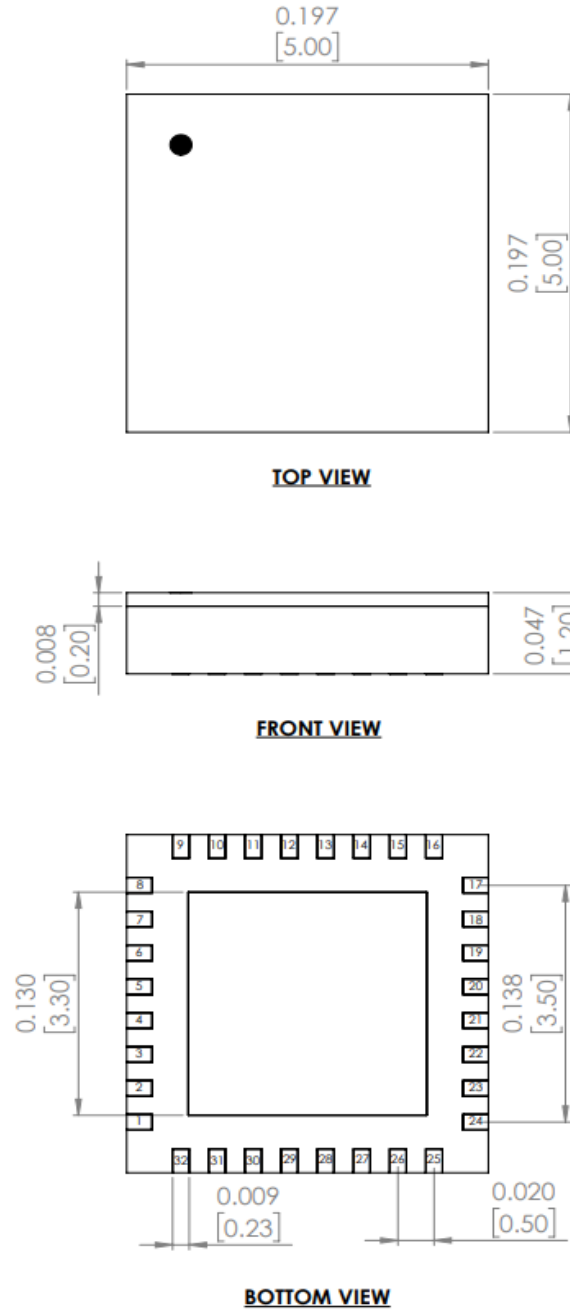

Unit: inches[mm]

4.5 – 6.0 GHz Low Noise Amplifier



ALND-WB-0011

Request Samples

Check Inventory

5.0 x 5.0 x 1.2 mm
RoHS Compliant

Test Fixture Data

Gain

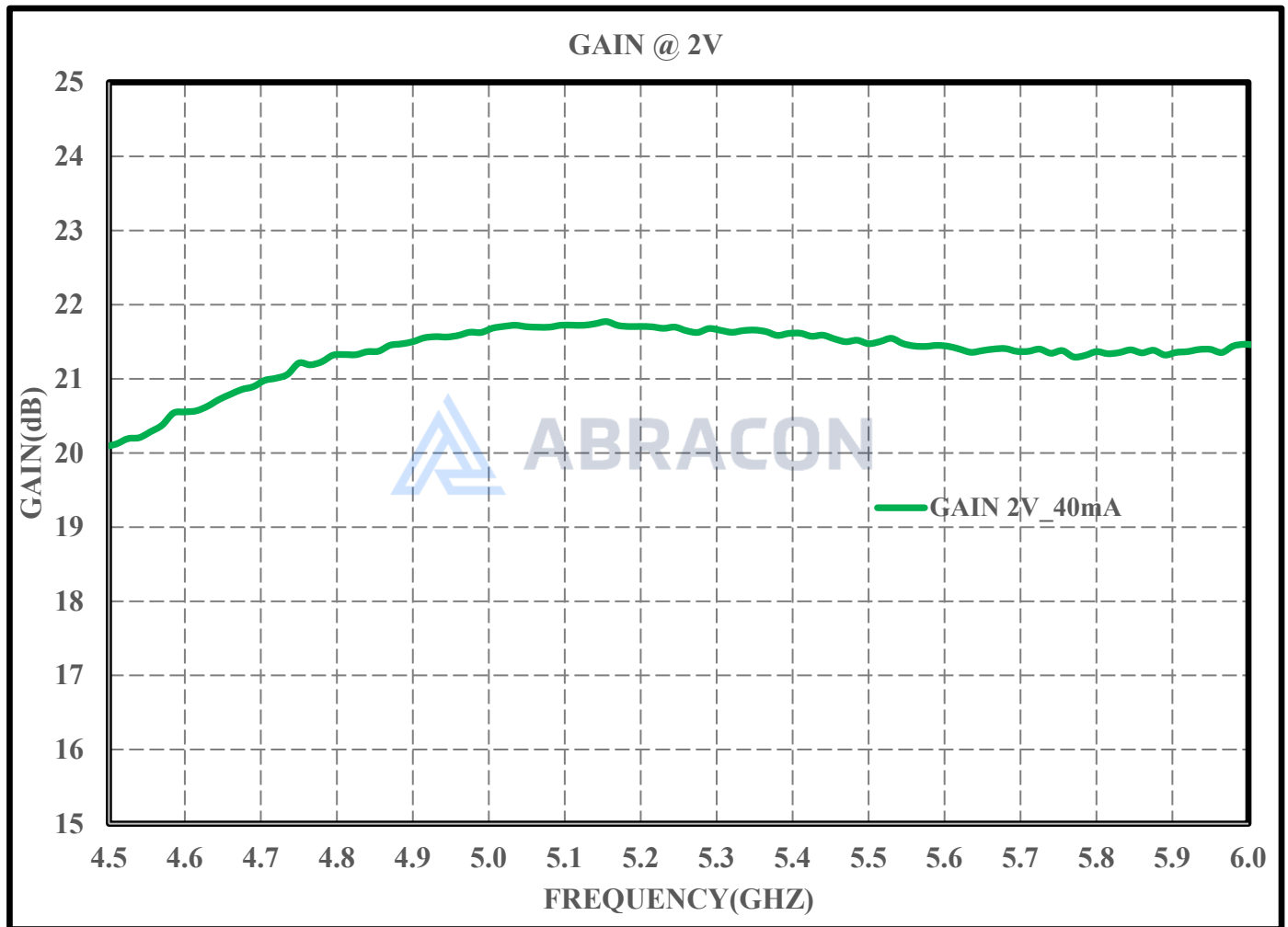

Vd = +2V, Total Current = 40mA, Ta = 25°C, Zo = 50 Ω

4.5 – 6.0 GHz Low Noise Amplifier



ALND-WB-0011

Request Samples



Check Inventory



5.0 x 5.0 x 1.2 mm
RoHS Compliant

Input Return Loss

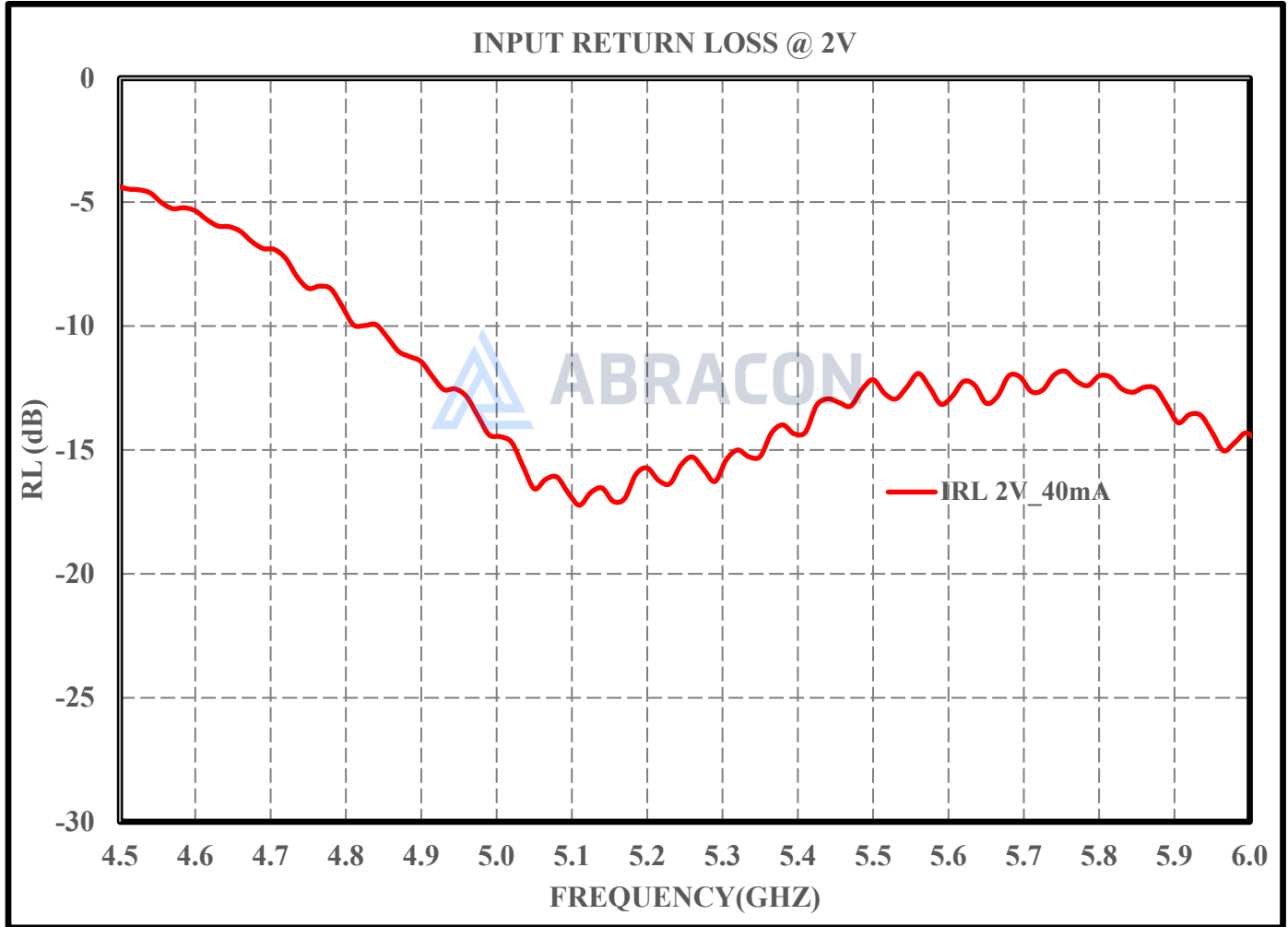

4.5 – 6.0 GHz Low Noise Amplifier



ALND-WB-0011

Request Samples



Check Inventory



5.0 x 5.0 x 1.2 mm
RoHS Compliant

Output Return loss

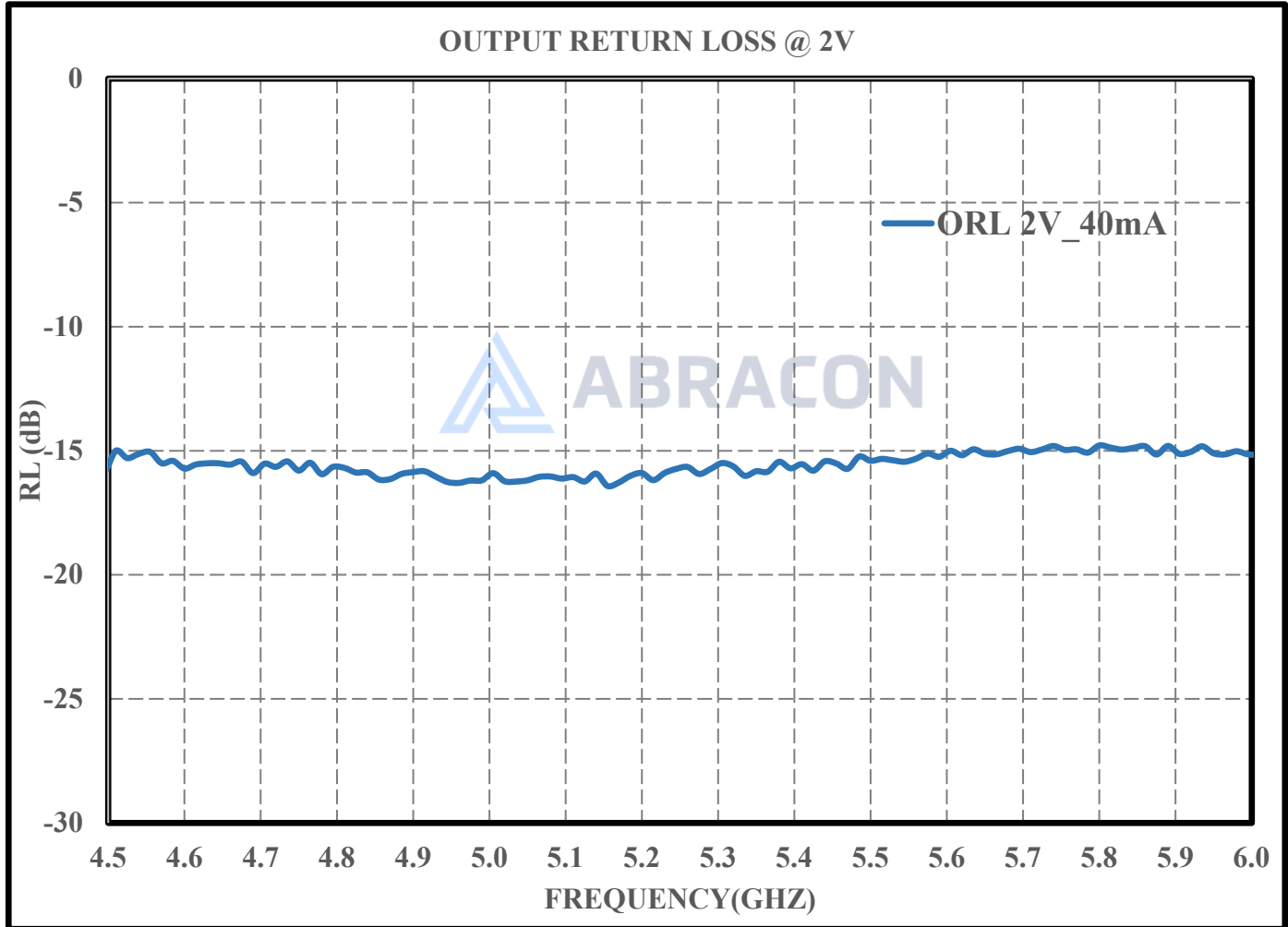

4.5 – 6.0 GHz Low Noise Amplifier



ALND-WB-0011

Request Samples



Check Inventory



5.0 x 5.0 x 1.2 mm
RoHS Compliant

Isolation

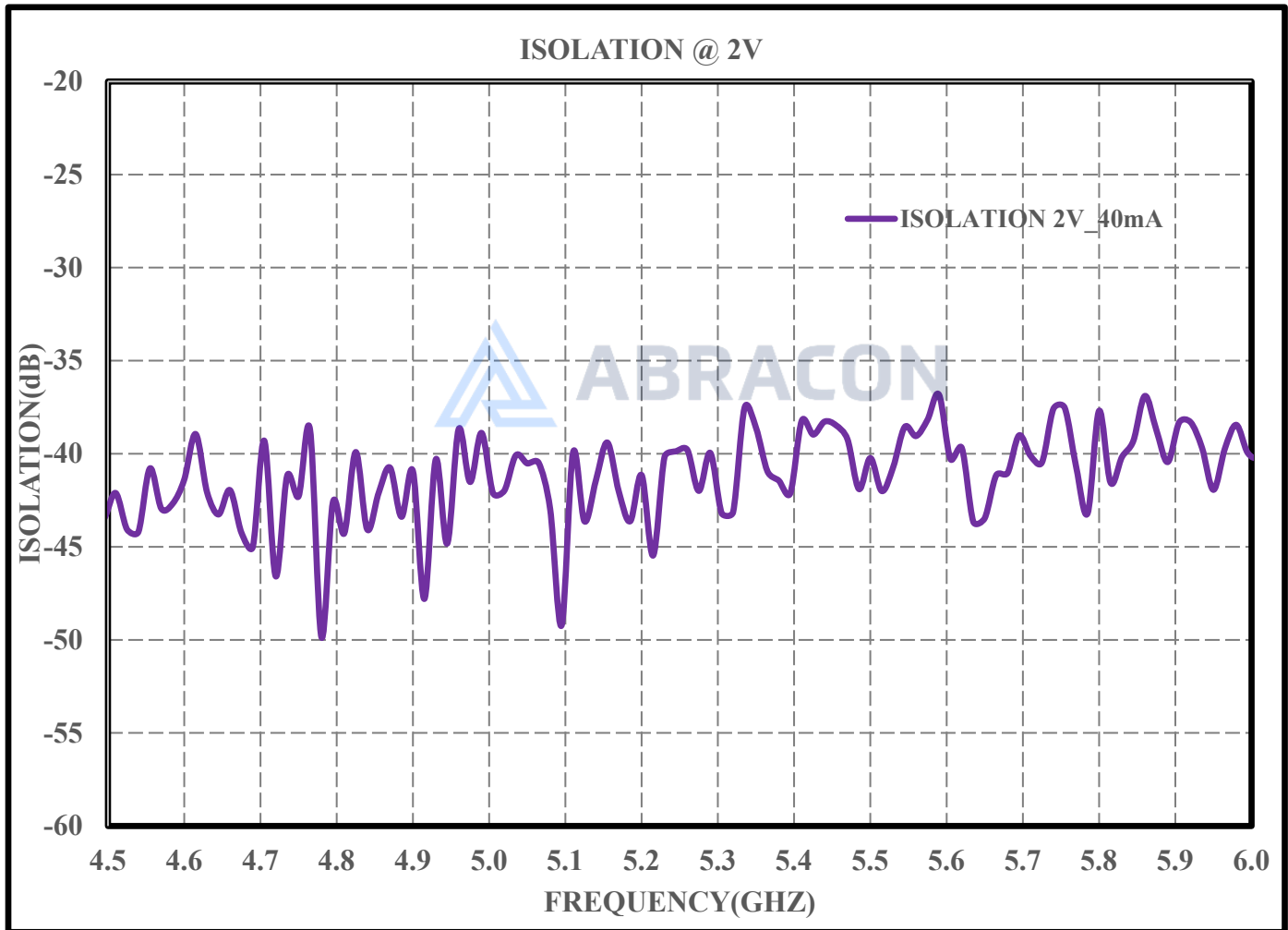

4.5 – 6.0 GHz Low Noise Amplifier



ALND-WB-0011

Request Samples

Check Inventory

5.0 x 5.0 x 1.2 mm
RoHS Compliant

Noise Figure

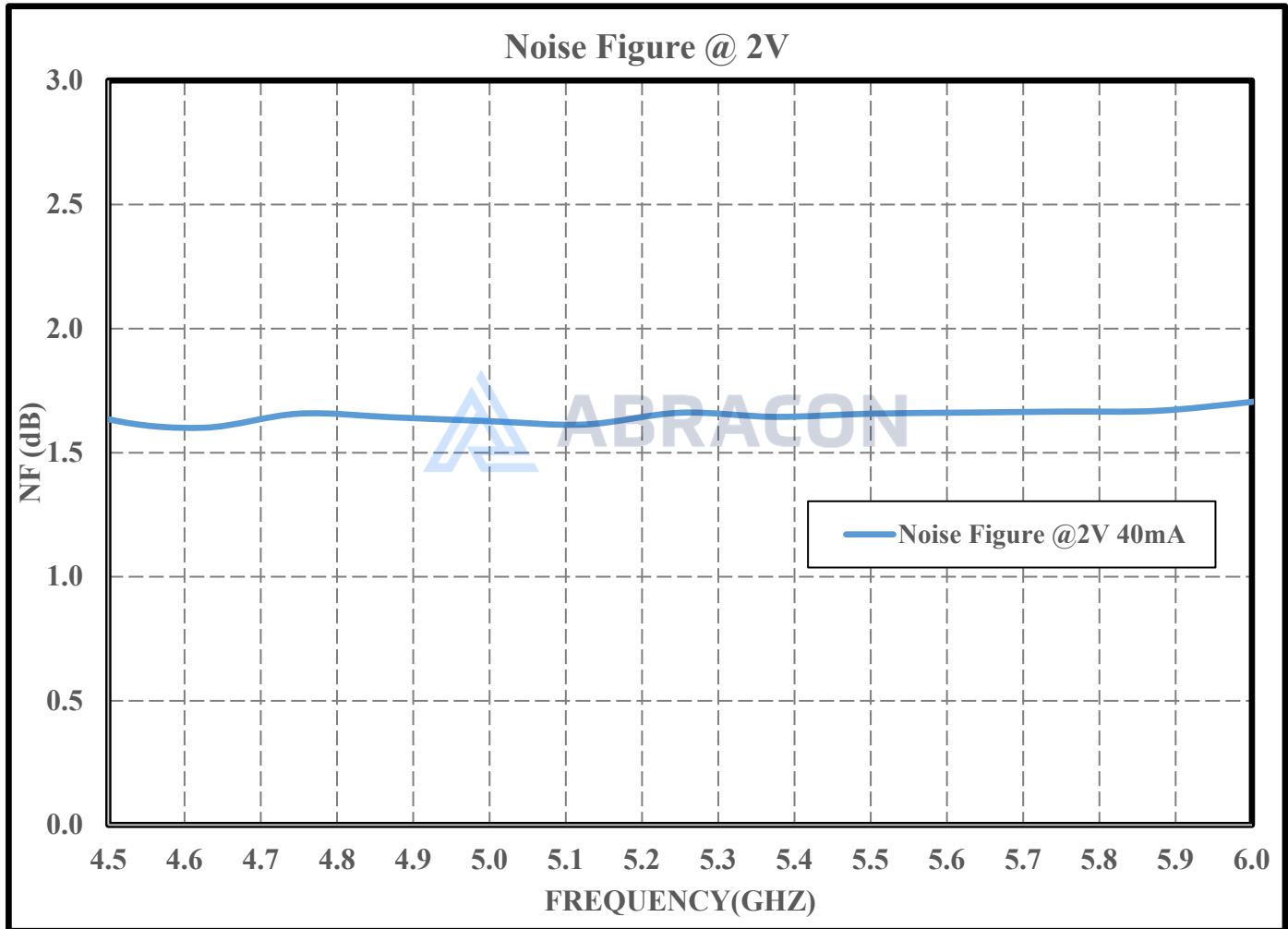

4.5 – 6.0 GHz Low Noise Amplifier



ALND-WB-0011

Request Samples



Check Inventory



5.0 x 5.0 x 1.2 mm
RoHS Compliant

P1dB

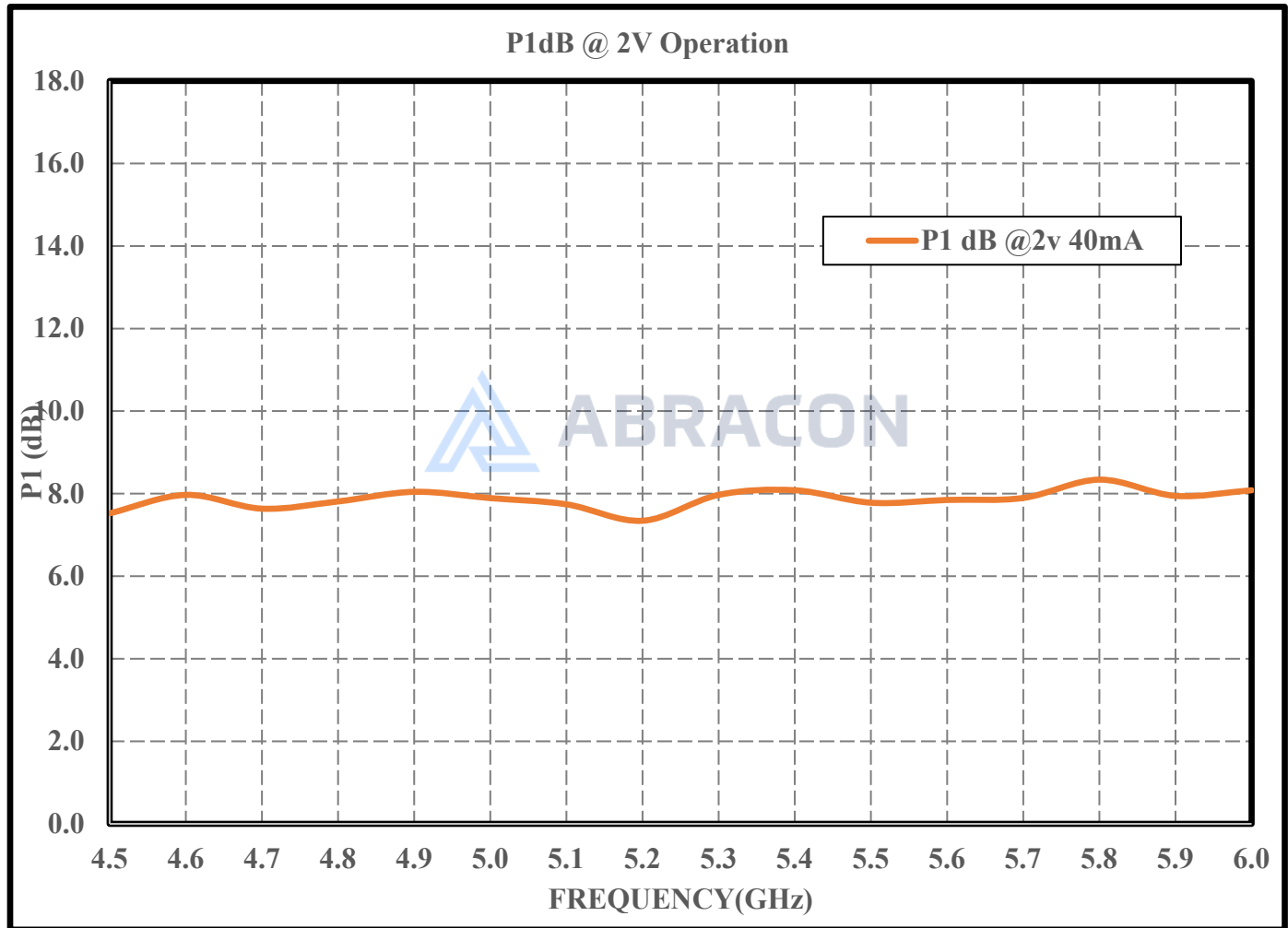

4.5 – 6.0 GHz Low Noise Amplifier



ALND-WB-0011

Request Samples



Check Inventory



5.0 x 5.0 x 1.2 mm
RoHS Compliant

OIP3

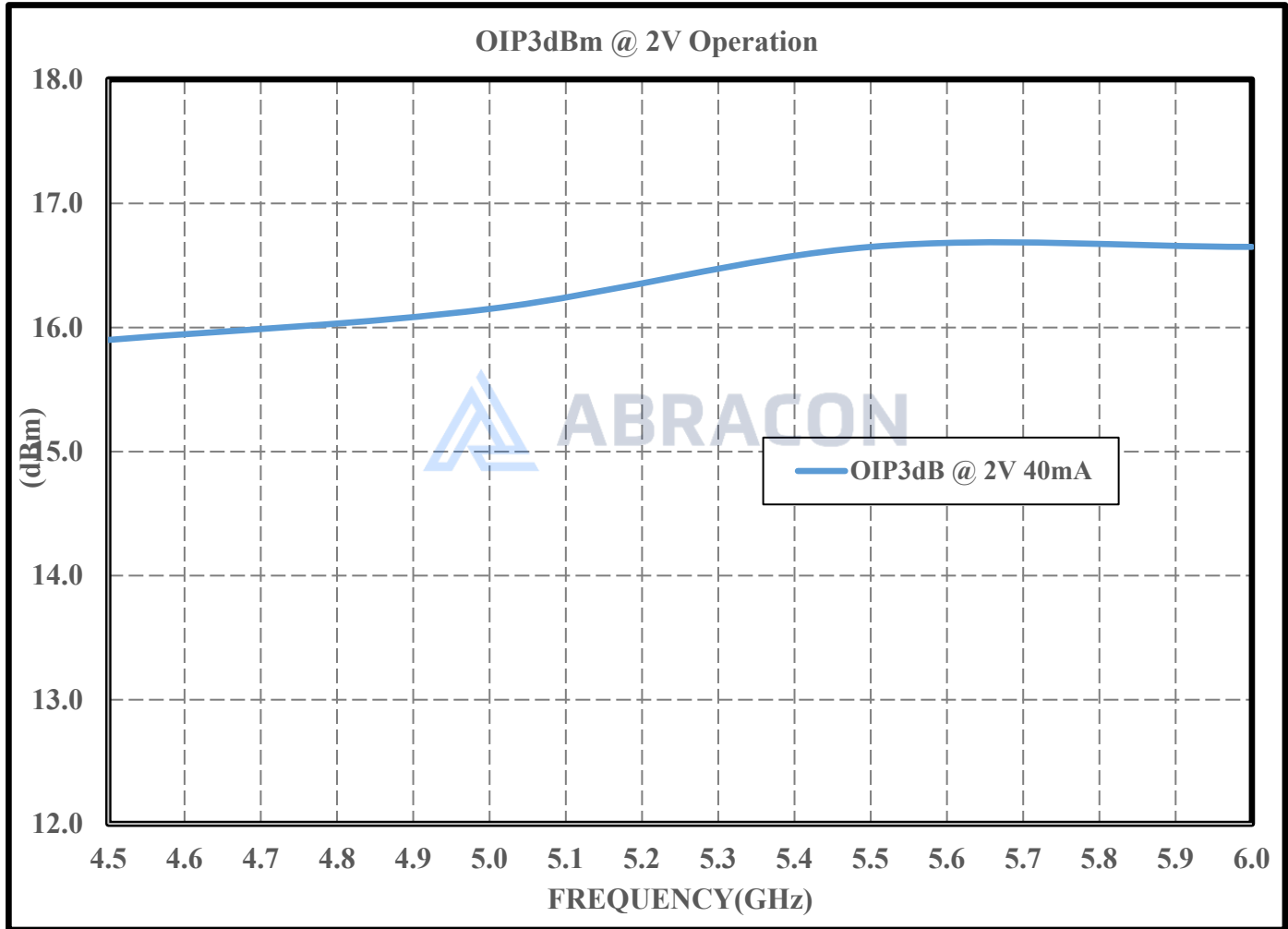

4.5 – 6.0 GHz Low Noise Amplifier



ALND-WB-0011

Request Samples



Check Inventory



5.0 x 5.0 x 1.2 mm
RoHS Compliant

Test Fixture Data Over the temperature

Output Return Loss

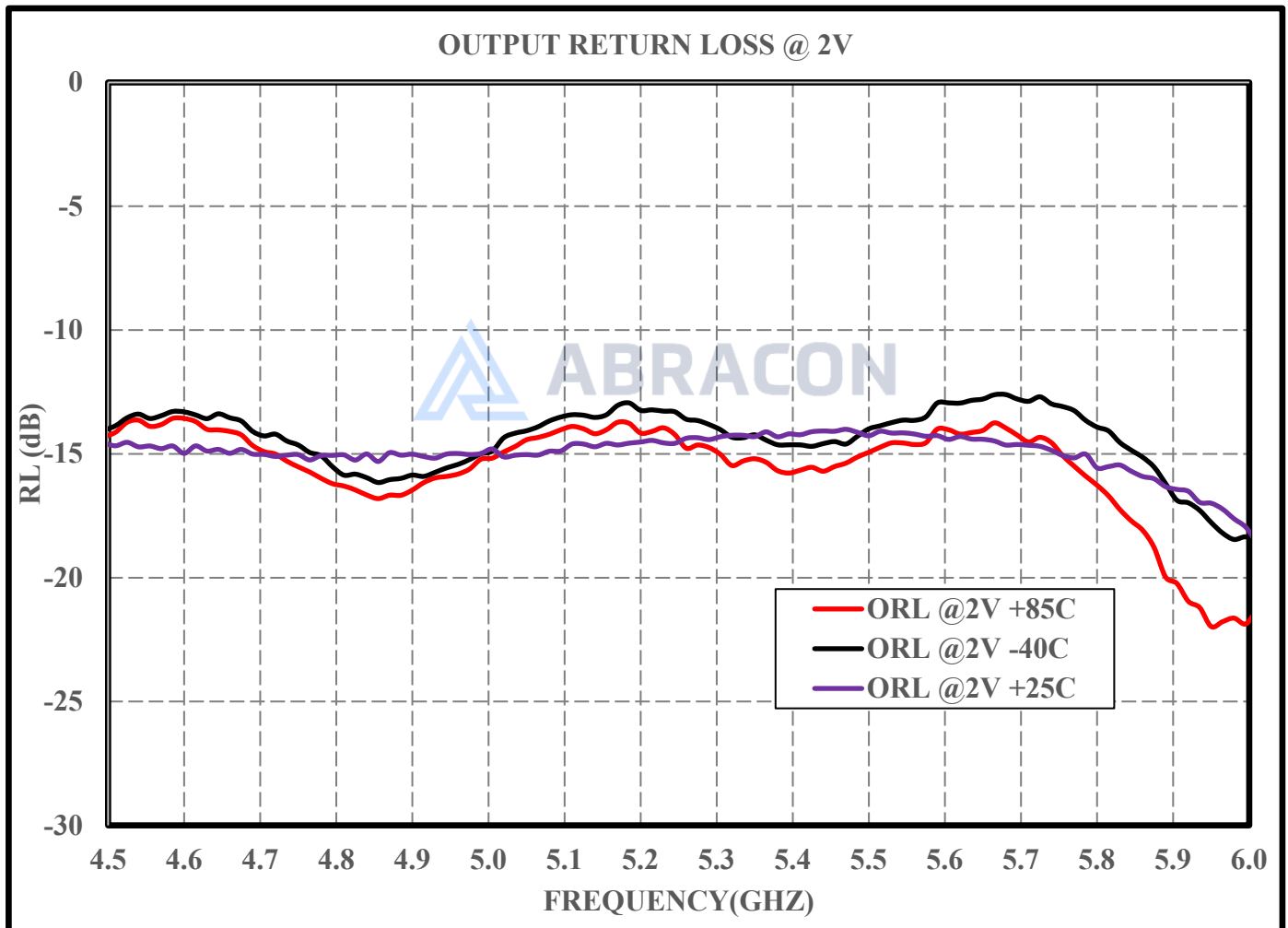

4.5 – 6.0 GHz Low Noise Amplifier



ALND-WB-0011

Request Samples



Check Inventory



5.0 x 5.0 x 1.2 mm
RoHS Compliant

Input Return Loss

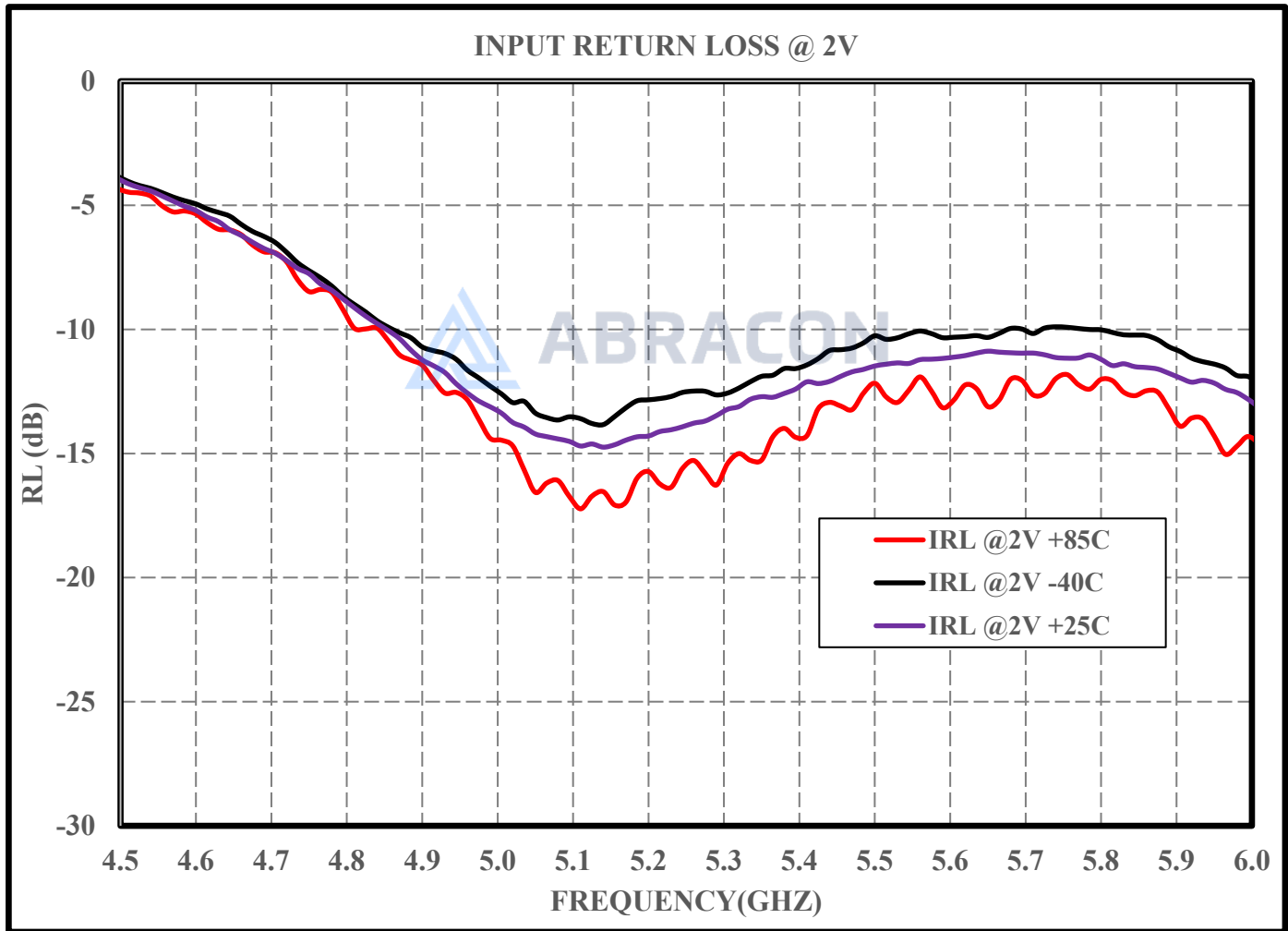

4.5 – 6.0 GHz Low Noise Amplifier



ALND-WB-0011

Request Samples



Check Inventory



5.0 x 5.0 x 1.2 mm
RoHS Compliant

Gain

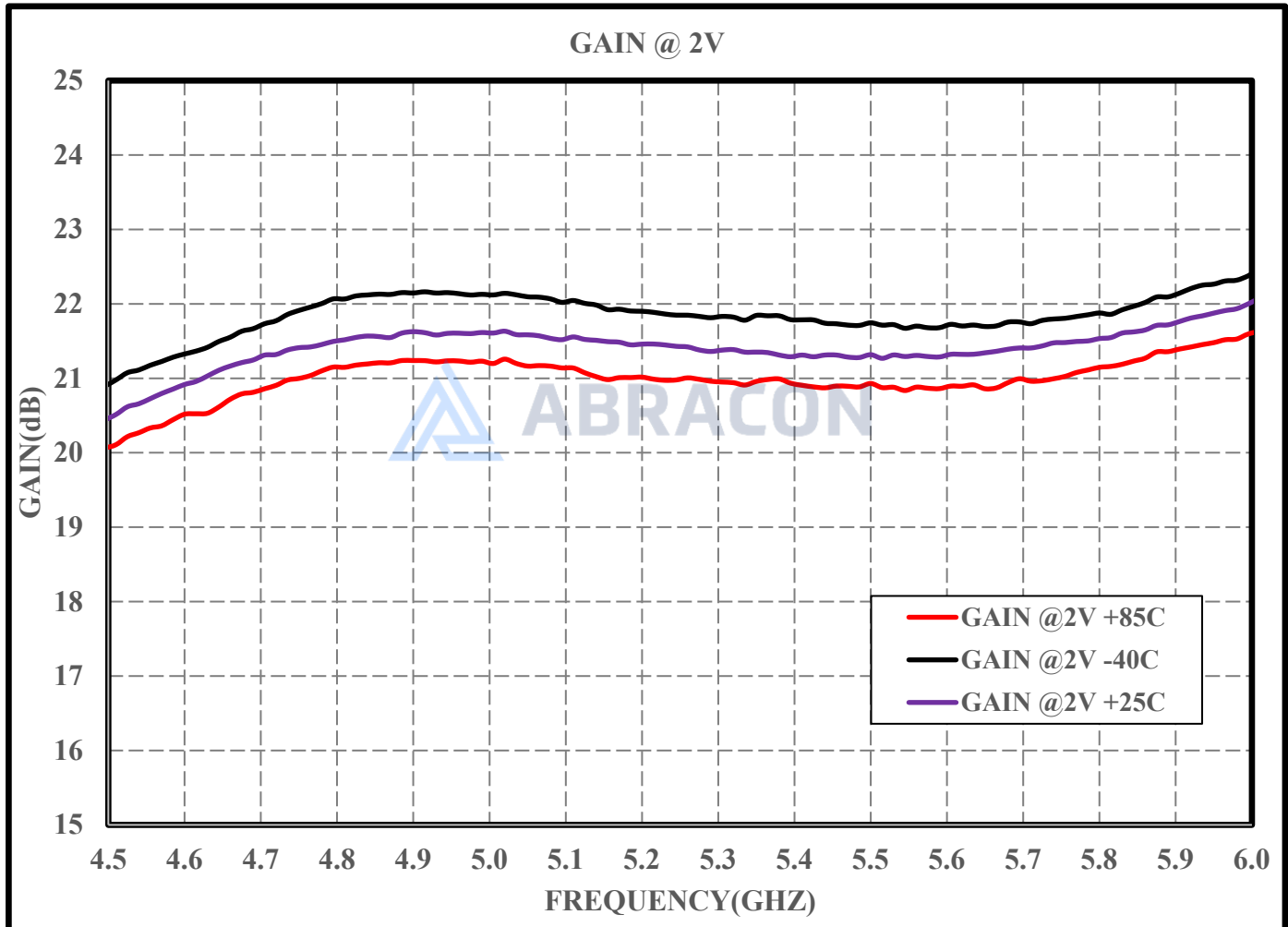

4.5 – 6.0 GHz Low Noise Amplifier



ALND-WB-0011

Request Samples



Check Inventory



5.0 x 5.0 x 1.2 mm
RoHS Compliant

Isolation

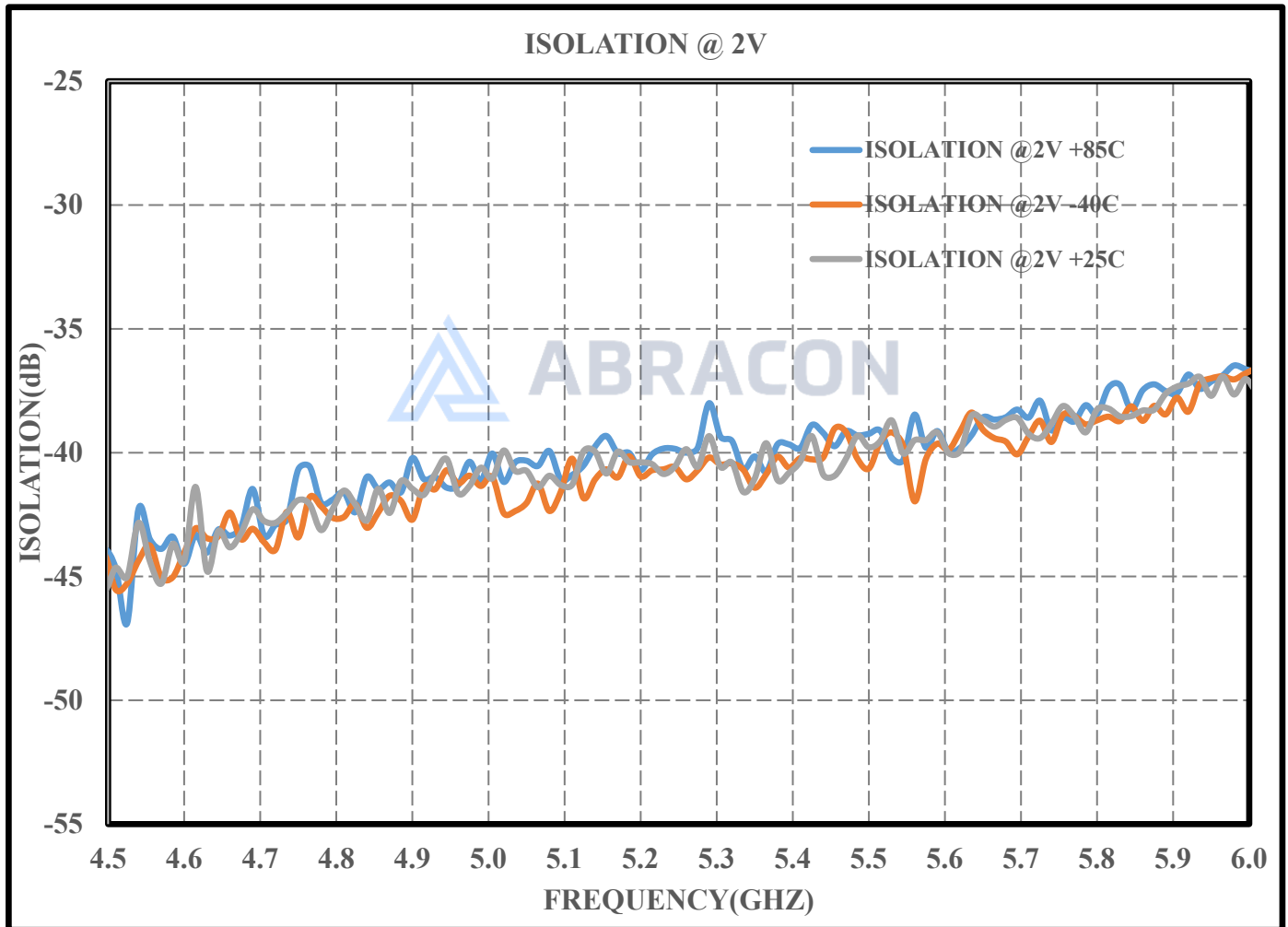

4.5 – 6.0 GHz Low Noise Amplifier



ALND-WB-0011

Request Samples



Check Inventory



5.0 x 5.0 x 1.2 mm
RoHS Compliant

Noise Figure

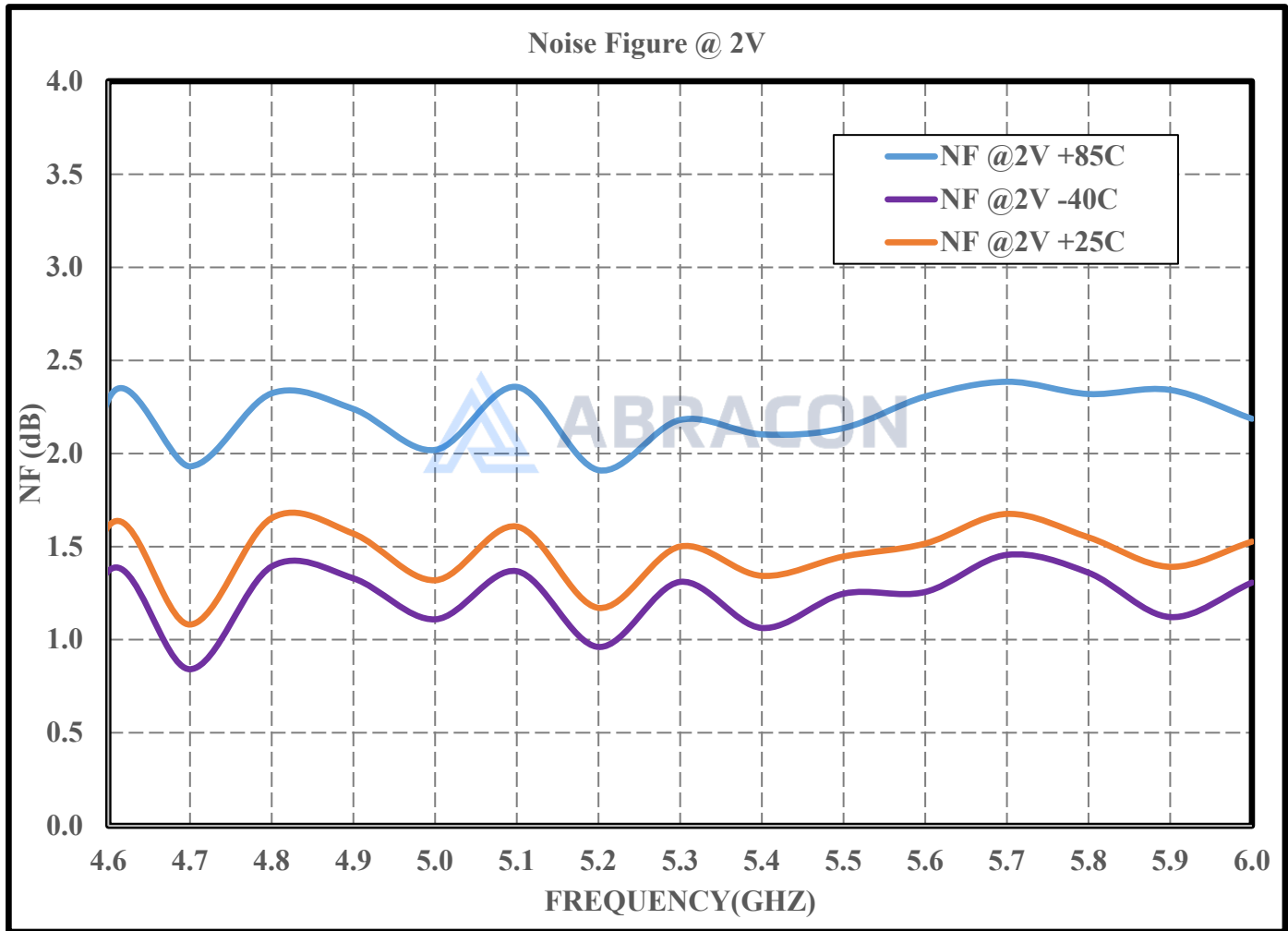

4.5 – 6.0 GHz Low Noise Amplifier



ALND-WB-0011

Request Samples



Check Inventory



5.0 x 5.0 x 1.2 mm
RoHS Compliant

At Different Biasing Conditions

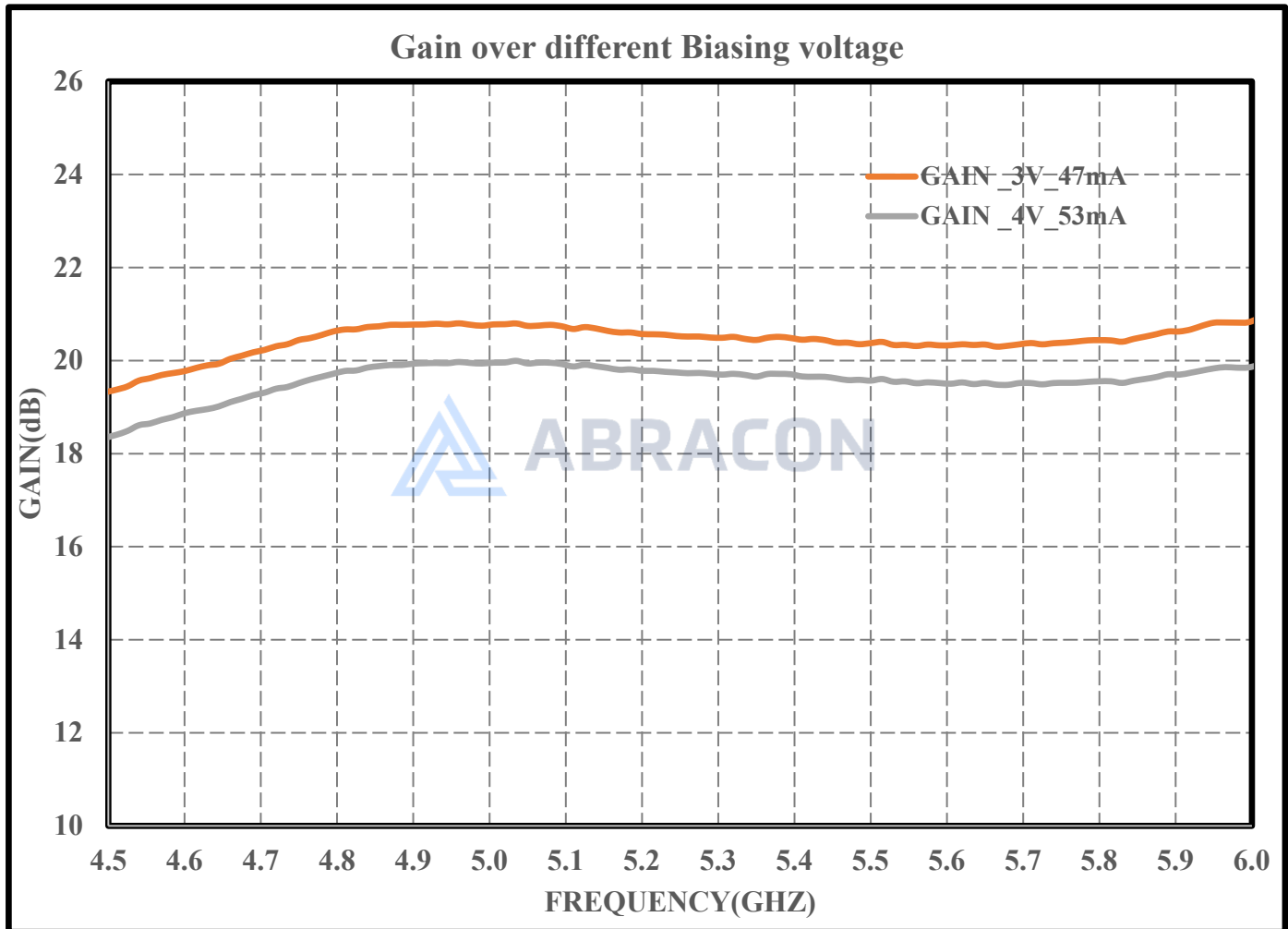

4.5 – 6.0 GHz Low Noise Amplifier



ALND-WB-0011

Request Samples



Check Inventory



5.0 x 5.0 x 1.2 mm
RoHS Compliant

Input & Output Return loss over different Biasing voltage

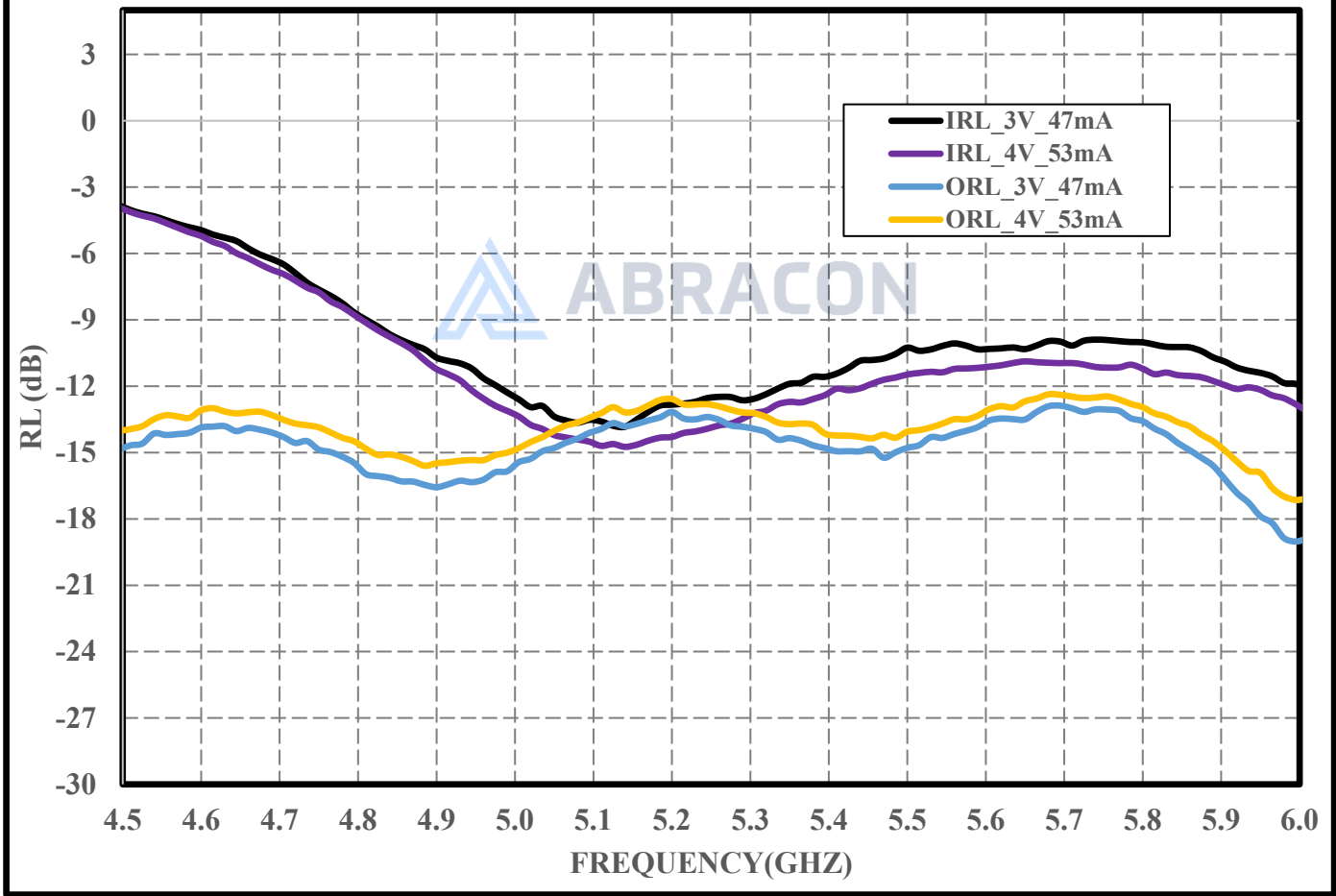

4.5 – 6.0 GHz Low Noise Amplifier



ALND-WB-0011

Request Samples



Check Inventory



5.0 x 5.0 x 1.2 mm
RoHS Compliant

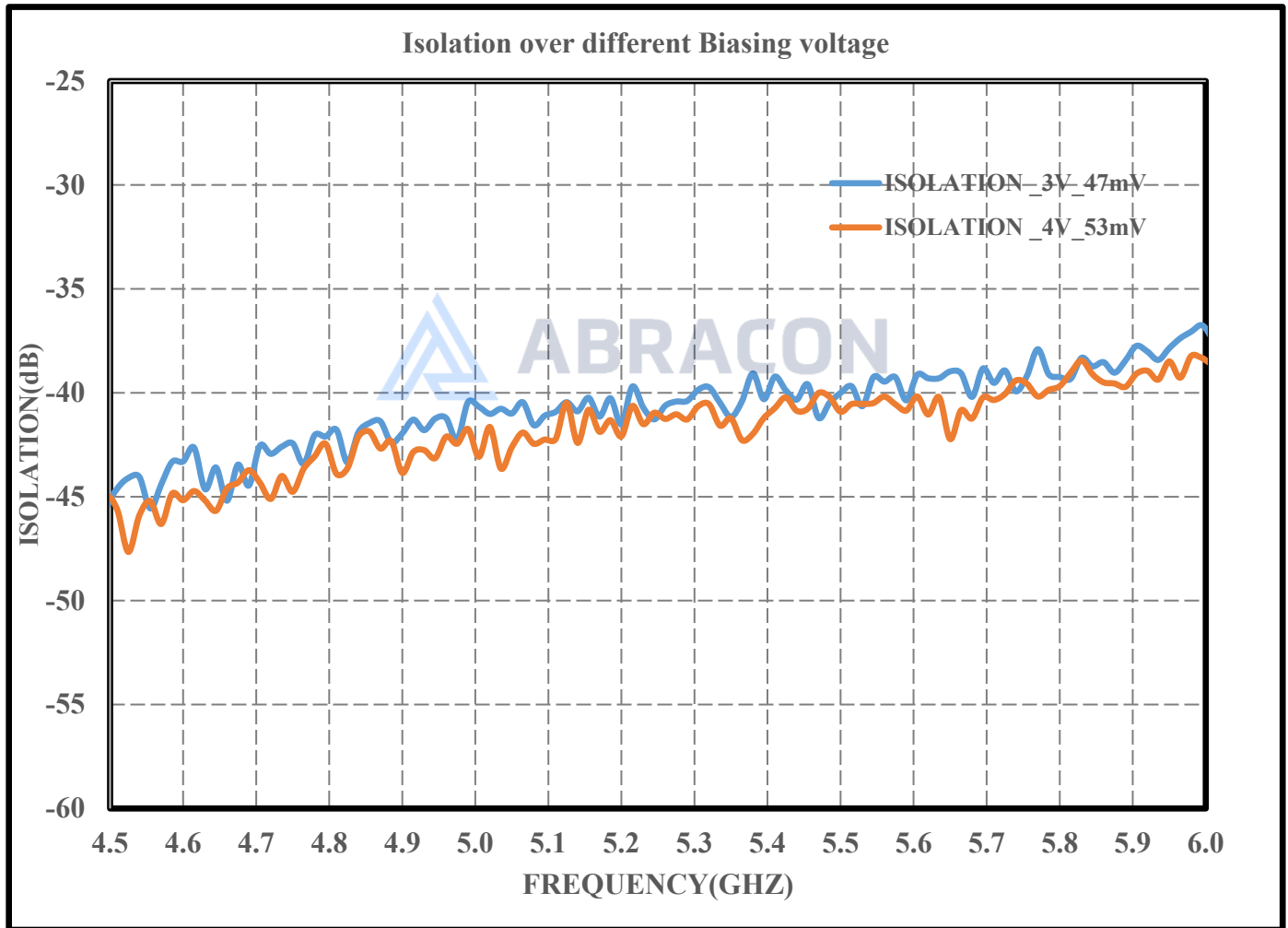

4.5 – 6.0 GHz Low Noise Amplifier



ALND-WB-0011

Request Samples



Check Inventory



5.0 x 5.0 x 1.2 mm
RoHS Compliant

Noise Figure over different Biasing voltage

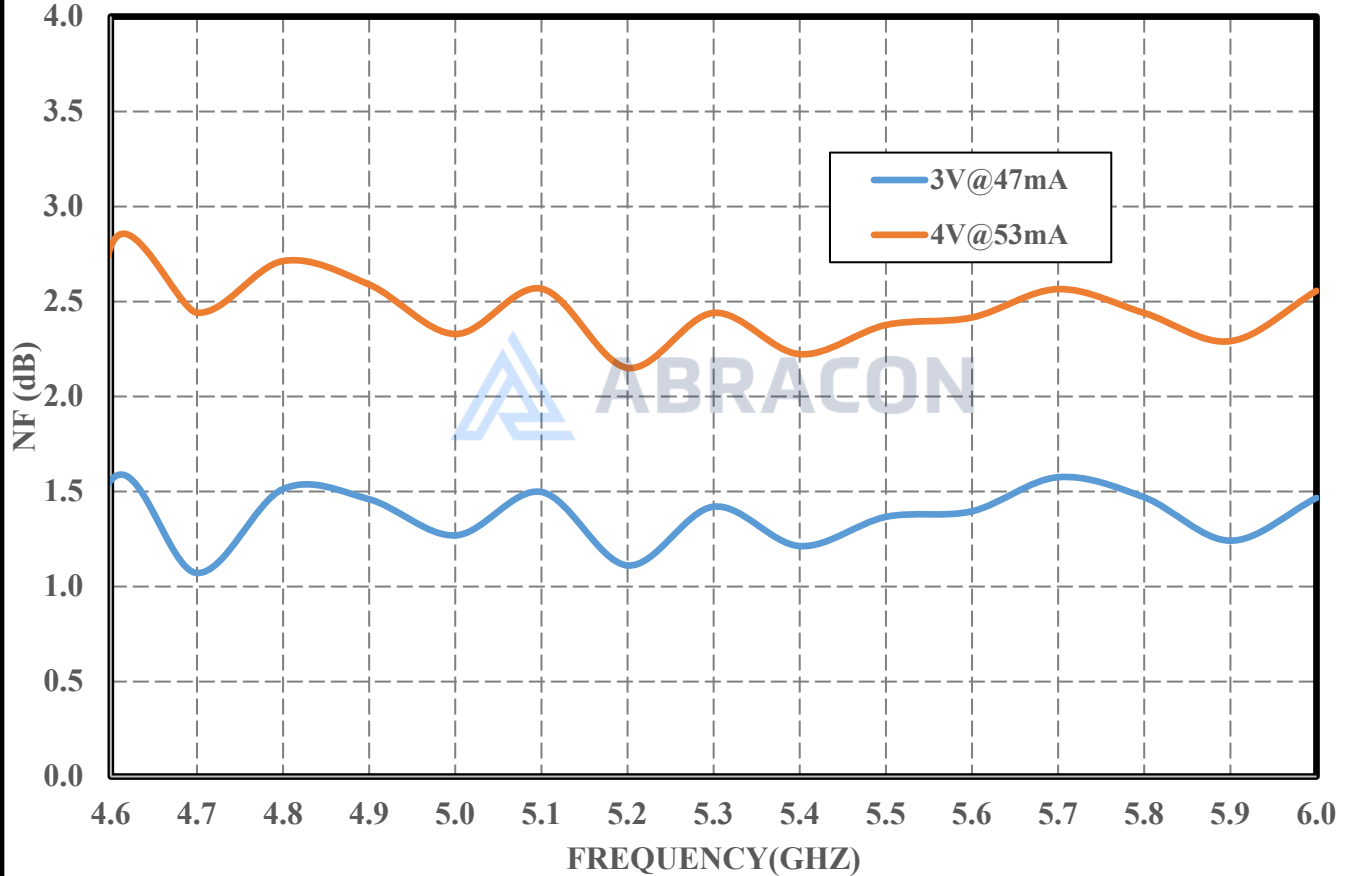

4.5 – 6.0 GHz Low Noise Amplifier



ALND-WB-0011

Request Samples



Check Inventory



5.0 x 5.0 x 1.2 mm
RoHS Compliant

Pin Configuration

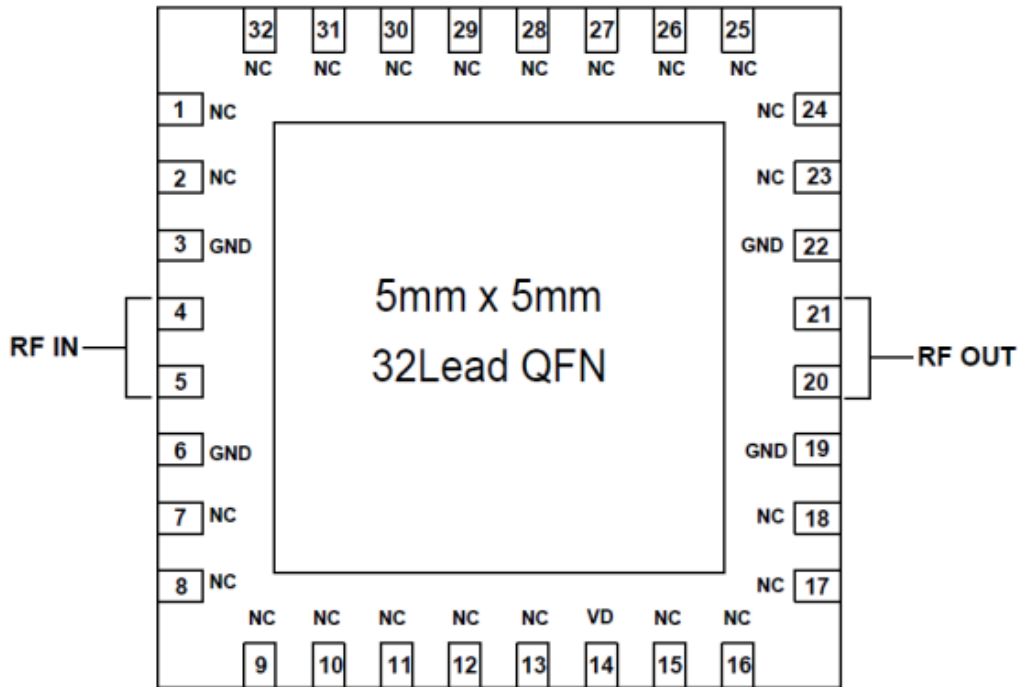

Pin Description:

Pin	Function	Description
14	VD	DC Supply Voltage
3,6,19,22	GND	Ground
4,5	RF IN	RF Input
20,21	RF OUT	RF Output
1,2,6,7,8,9,10,11,12,13,15,16,17,18, 23,24,25,26,28,29,30,31,32	NC	No Connection

4.5 – 6.0 GHz Low Noise Amplifier



ALND-WB-0011

Request Samples



Check Inventory



5.0 x 5.0 x 1.2 mm
RoHS Compliant

Test Board Pattern

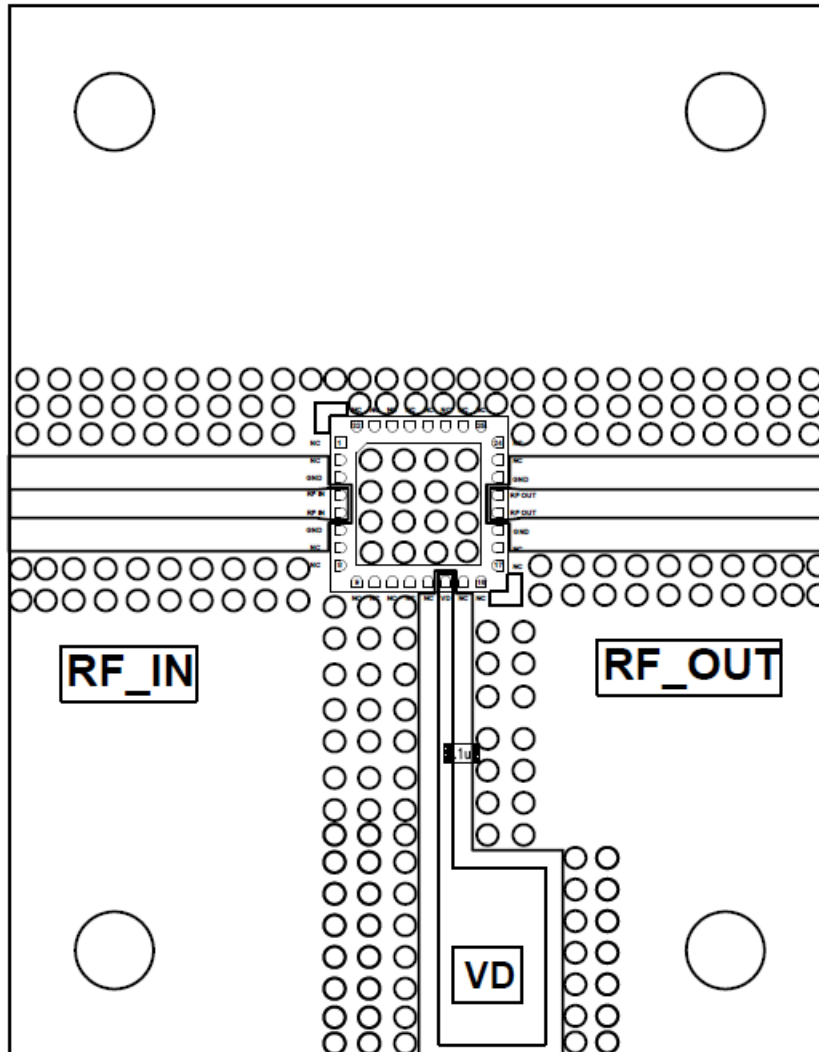

NOTES:

- capacitor value is 0.1uF

4.5 – 6.0 GHz Low Noise Amplifier



ALND-WB-0011

Request Samples



Check Inventory



5.0 x 5.0 x 1.2 mm
RoHS Compliant

Packaging

Packing Tubes

10pcs per tube, 50 tubes per box

ATTENTION: Abracon LLC's products are COTS – Commercial-Off-The-Shelf products; suitable for Commercial, Industrial and, where designated, Automotive Applications. Abracon's products are not specifically designed for Military, Aviation, Aerospace, Life-dependent Medical applications or any application requiring high reliability where component failure could result in loss of life and/or property. For applications requiring high reliability and/or presenting an extreme operating environment, written consent and authorization from Abracon LLC is required. Please contact Abracon LLC for more information.



5101 Hidden Creek Ln Spicewood TX 78669

Phone: 512-371-6159 | Fax: 512-351-8858
For terms and conditions of sales, please visit:
www.abracon.com

REVISED: 07-31-24

ABRACON IS
ISO9001-2015
CERTIFIED