

2.7 – 3.7 GHz Low Noise Amplifier

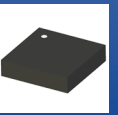

ALND-WB-0009

Request Samples



Check Inventory



5.0 x 5.0 x 1.2 mm
RoHS Compliant

Features

- Frequency Range: 2.7 - 3.7 GHz
- Low Noise Figure < 1.4 dB
- 24 dB High Gain
- 18 dBm Medium Power Output
- Input Return Loss > 4 dB.
- Output Return Loss > 15 dB.
- No external matching required.
- DC Decoupled input and output
- 0.15 μ m In GaAs PHEMT Technology
- QFN Plastic package: 5.0 x 5.0 x 1.2 mm

Applications

- Military Radar
- Multi-Band VSAT
- Cellular Infrastructure Base Station
- Repeaters / Boosters / DAS

Product Image

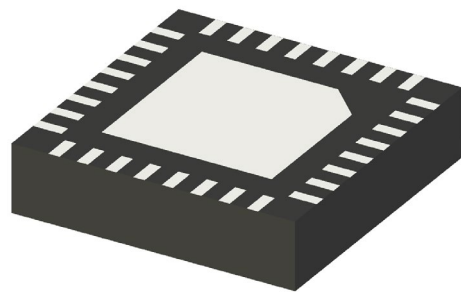
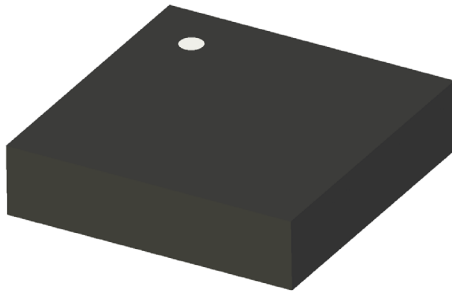

2.7 – 3.7 GHz Low Noise Amplifier

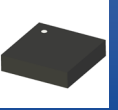

ALND-WB-0009

Request Samples

Check Inventory

5.0 x 5.0 x 1.2 mm
RoHS Compliant

Functional Diagram

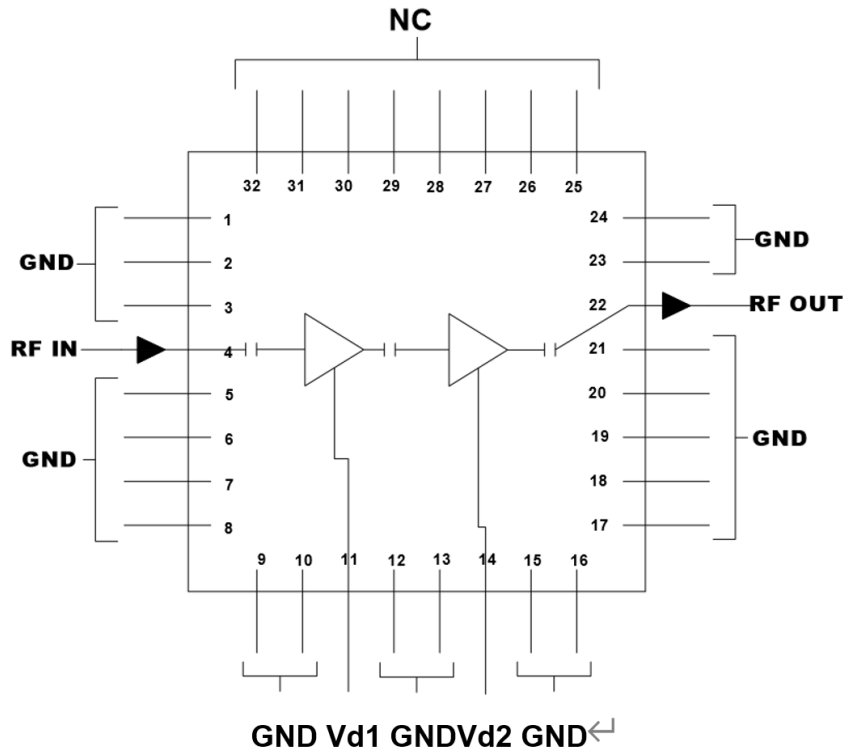

Absolute Maximum Ratings

Parameter	Absolute Maximum	Units
Drain bias voltage (Vd)	+6	V
RF input power (RF in at Vd=4V)	+18	dBm
Operating Temperature	-50 to +85	°C
Storage Temperature	-65 to +150	°C

1. Operation beyond these limits may cause permanent damage to the component

2.7 – 3.7 GHz Low Noise Amplifier

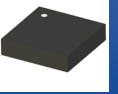

ALND-WB-0009

Request Samples



Check Inventory



5.0 x 5.0 x 1.2 mm
RoHS Compliant

Electrical Specifications

Parameters Description	Typical			Unit
	2.7 – 3.1	3.1 – 3.5	2.7 - 3.7	
Frequency Range	2.7 – 3.1	3.1 – 3.5	2.7 - 3.7	GHz
Gain	23.5	23.75	24.0	dB
Gain Flatness	+0.25	± 0.4	± 0.6	dB
Noise Figure	1.4	1.6	1.6	dB
Input Return Loss	5	11	5	dB
Output Return Loss	15	12	9	dB
Output Power (P1 dB)	18	19	18	dBm
Saturated output power (Psat)	-	21	-	dBm
Output Third Order Intercept (IP3)	-	30	-	dBm
Supply Current	-	110	-	mA

@ TA 25C, Vd1 = 3V, Vd2 = 4V Zo =50 Ω

NOTES:

1. Electrical specifications are measured in a test fixture

2.7 – 3.7 GHz Low Noise Amplifier

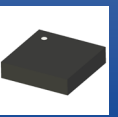

ALND-WB-0009

Request Samples



Check Inventory



5.0 x 5.0 x 1.2 mm
RoHS Compliant

Ordering Information

Part Number	Description
ALND-WB-0009	2.7 – 3.7 GHz Low Noise Amplifier Packing: Bulk

2.7 – 3.7 GHz Low Noise Amplifier

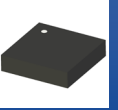

ALND-WB-0009

Request Samples



Check Inventory



5.0 x 5.0 x 1.2 mm
RoHS Compliant

Product Dimensions

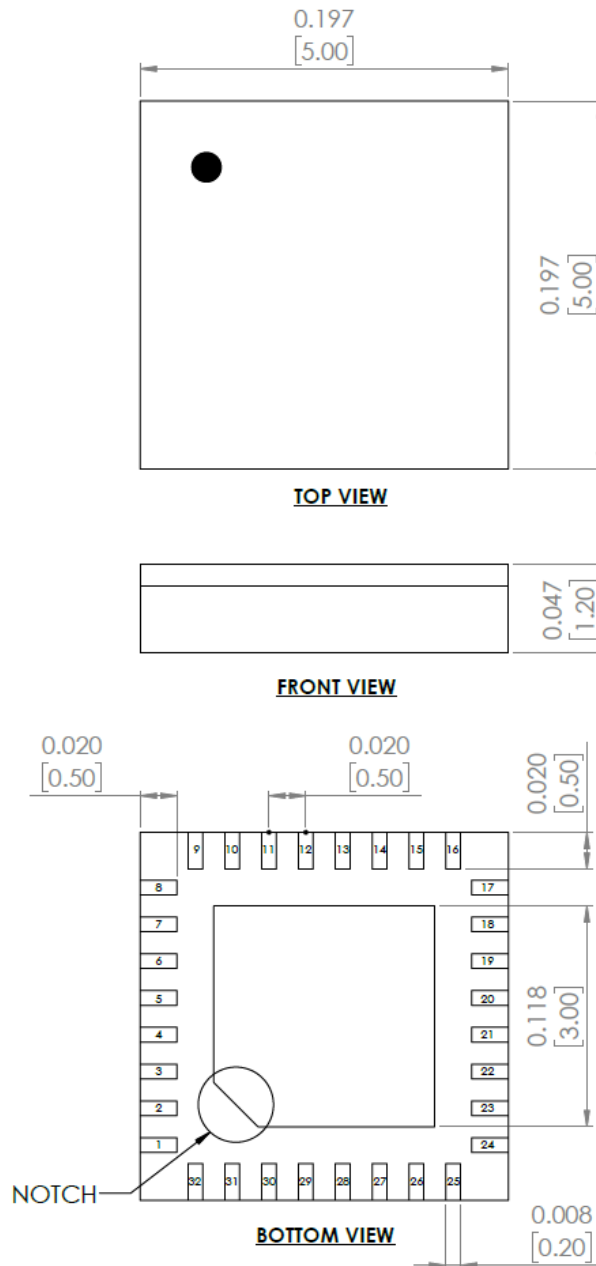

Unit: inches[mm]

2.7 – 3.7 GHz Low Noise Amplifier

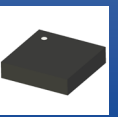

ALND-WB-0009

Request Samples



Check Inventory



5.0 x 5.0 x 1.2 mm
RoHS Compliant

Pin Configuration

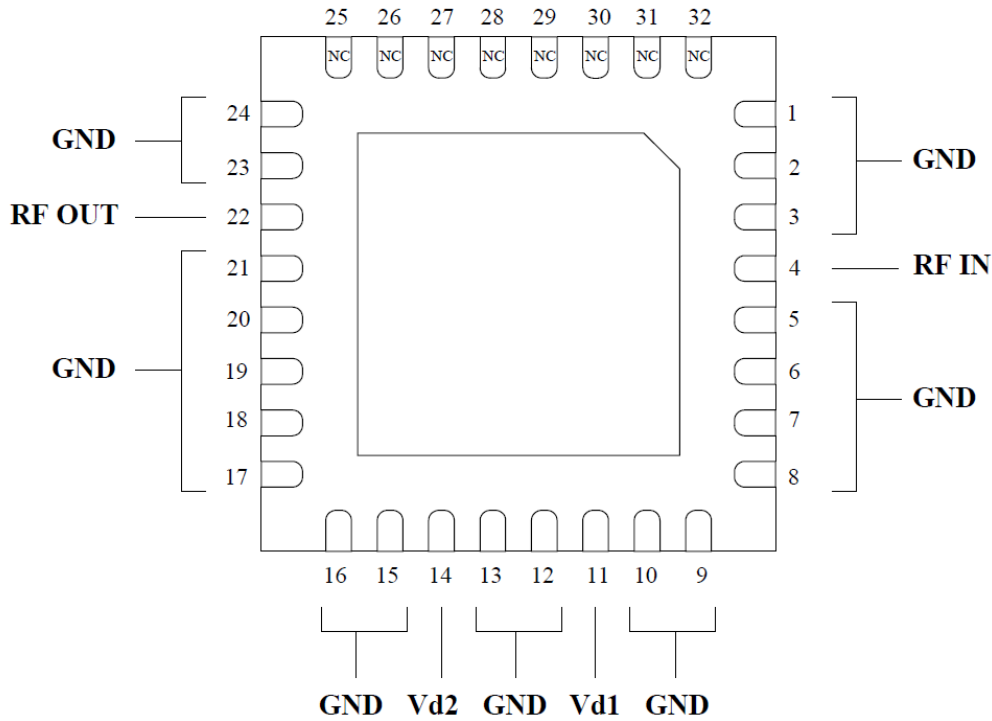

Pin Designations

Symbol	Pin No.	Description
GND	1,2,3,5,6,7,8,9,10,12,13,15,16,17,18,19,20,21,23,24	Grounded
RF IN	4	RF Input
RF OUT	22	RF Output
Vd1	11	1 st Stage drain voltage
Vd2	14	2 nd Stage drain voltage
NC	25,26,27,28,29,30,31,32	No Connection

2.7 – 3.7 GHz Low Noise Amplifier

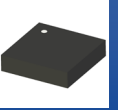

ALND-WB-0009

Request Samples

Check Inventory

5.0 x 5.0 x 1.2 mm
RoHS Compliant

Test Fixture Data

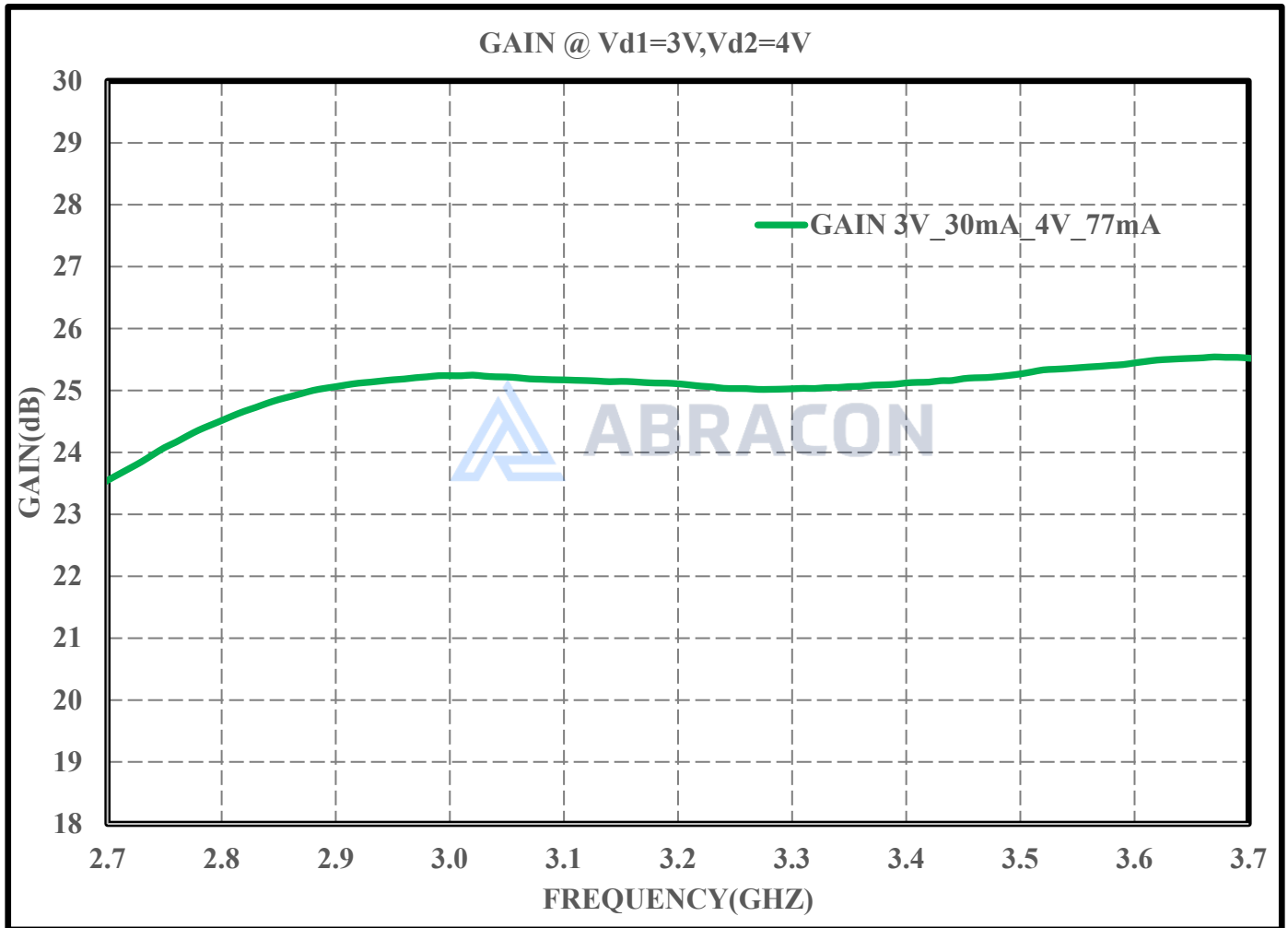

Vd1 = 3V, Vd2 = 4V, Total Current = 110mA, Ta = 25°C

2.7 – 3.7 GHz Low Noise Amplifier

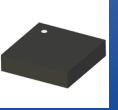

ALND-WB-0009

Request Samples



Check Inventory



5.0 x 5.0 x 1.2 mm
RoHS Compliant

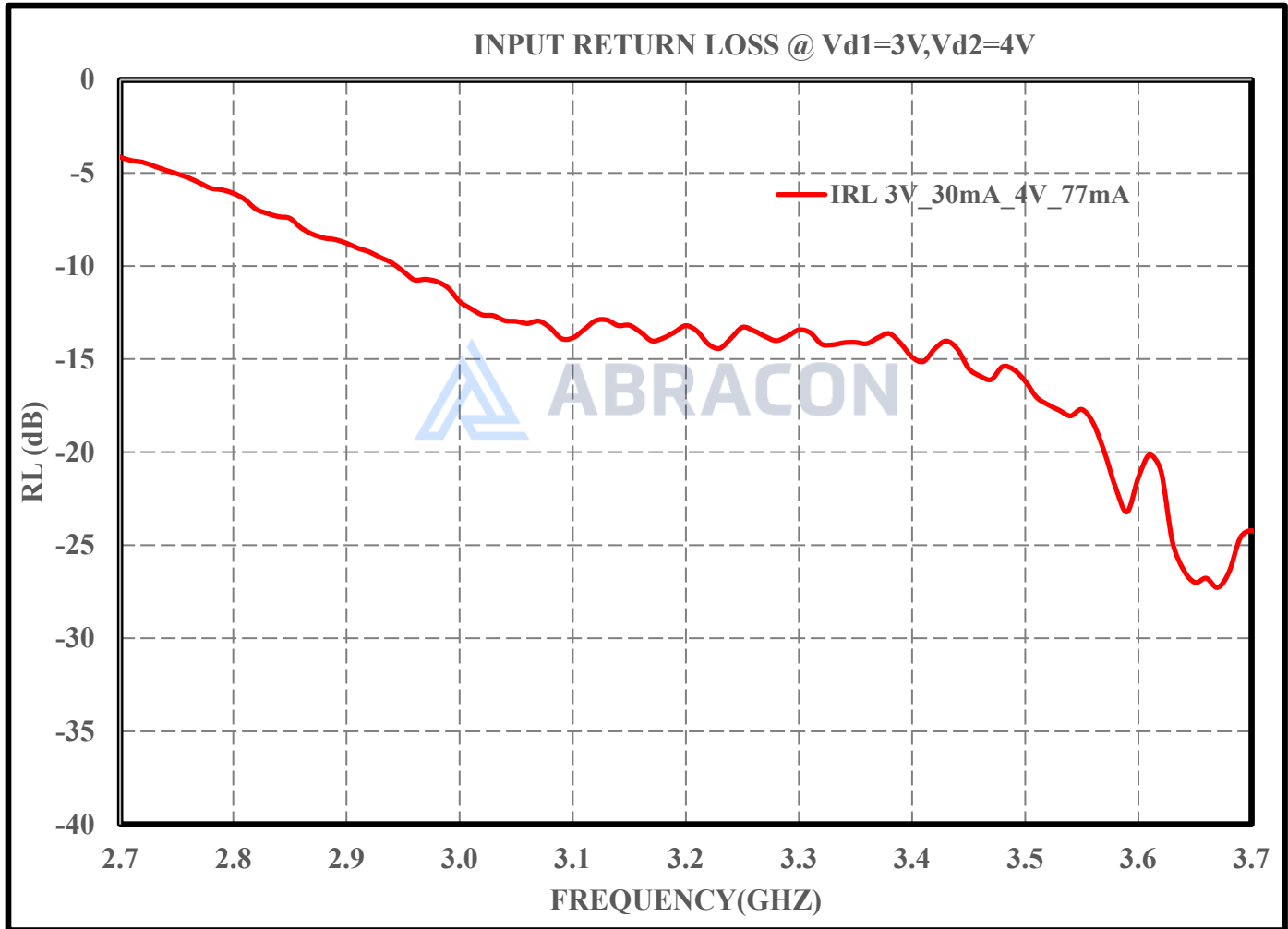

2.7 – 3.7 GHz Low Noise Amplifier

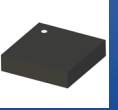

ALND-WB-0009

Request Samples



Check Inventory



5.0 x 5.0 x 1.2 mm
RoHS Compliant

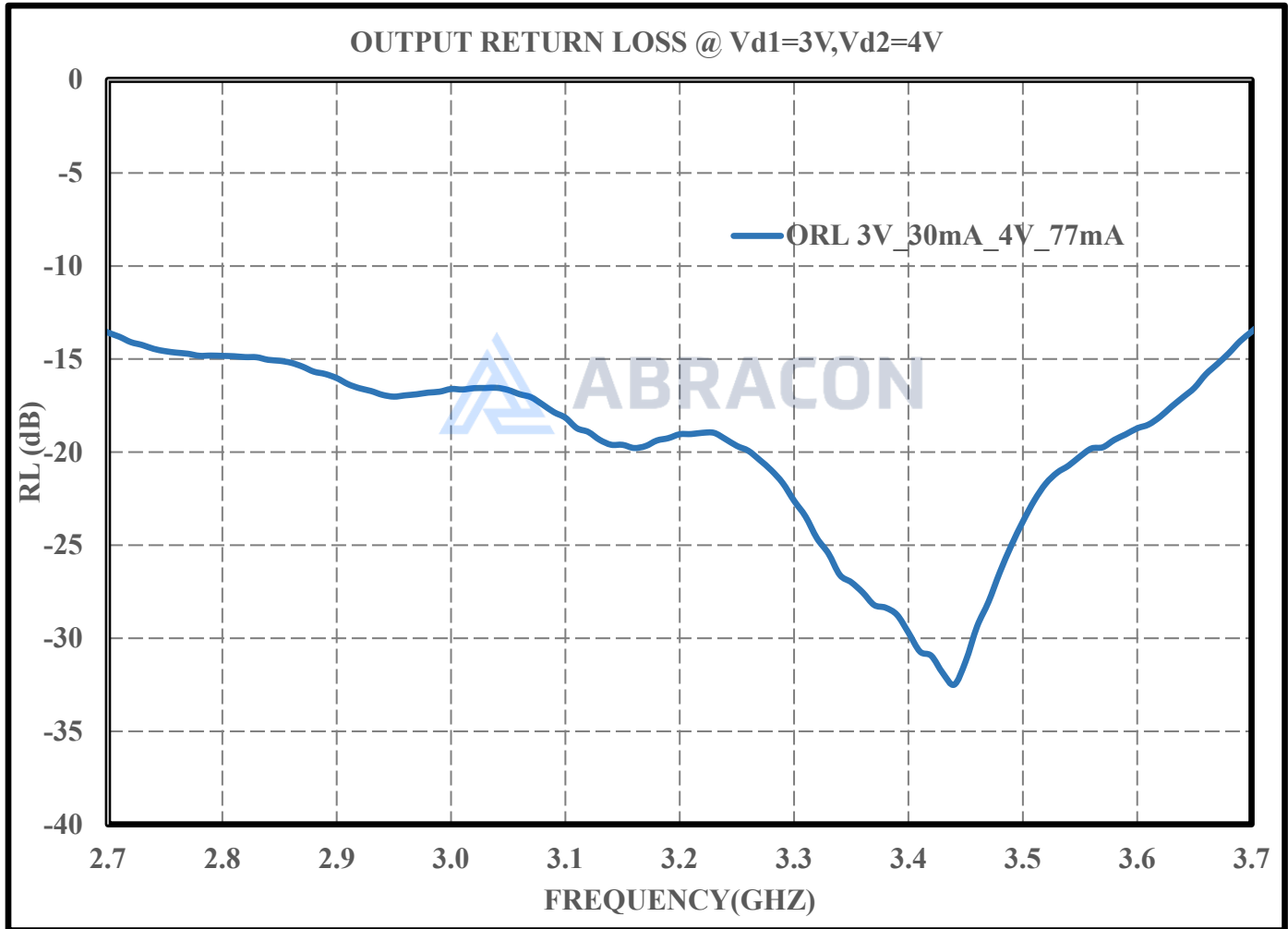

2.7 – 3.7 GHz Low Noise Amplifier

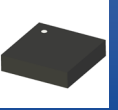

ALND-WB-0009

Request Samples

Check Inventory

5.0 x 5.0 x 1.2 mm
RoHS Compliant

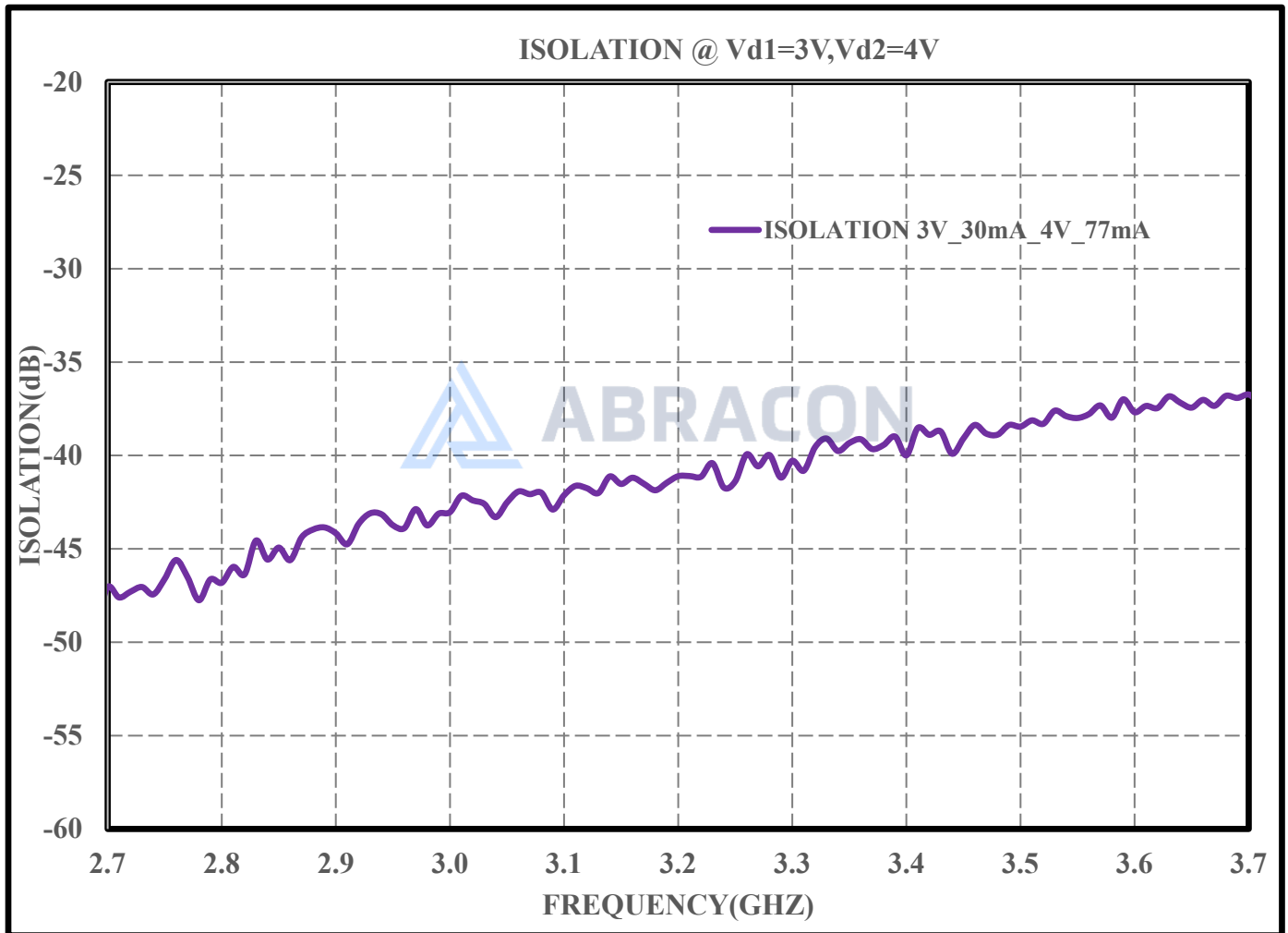

2.7 – 3.7 GHz Low Noise Amplifier

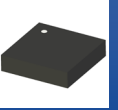

ALND-WB-0009

Request Samples



Check Inventory



5.0 x 5.0 x 1.2 mm
RoHS Compliant

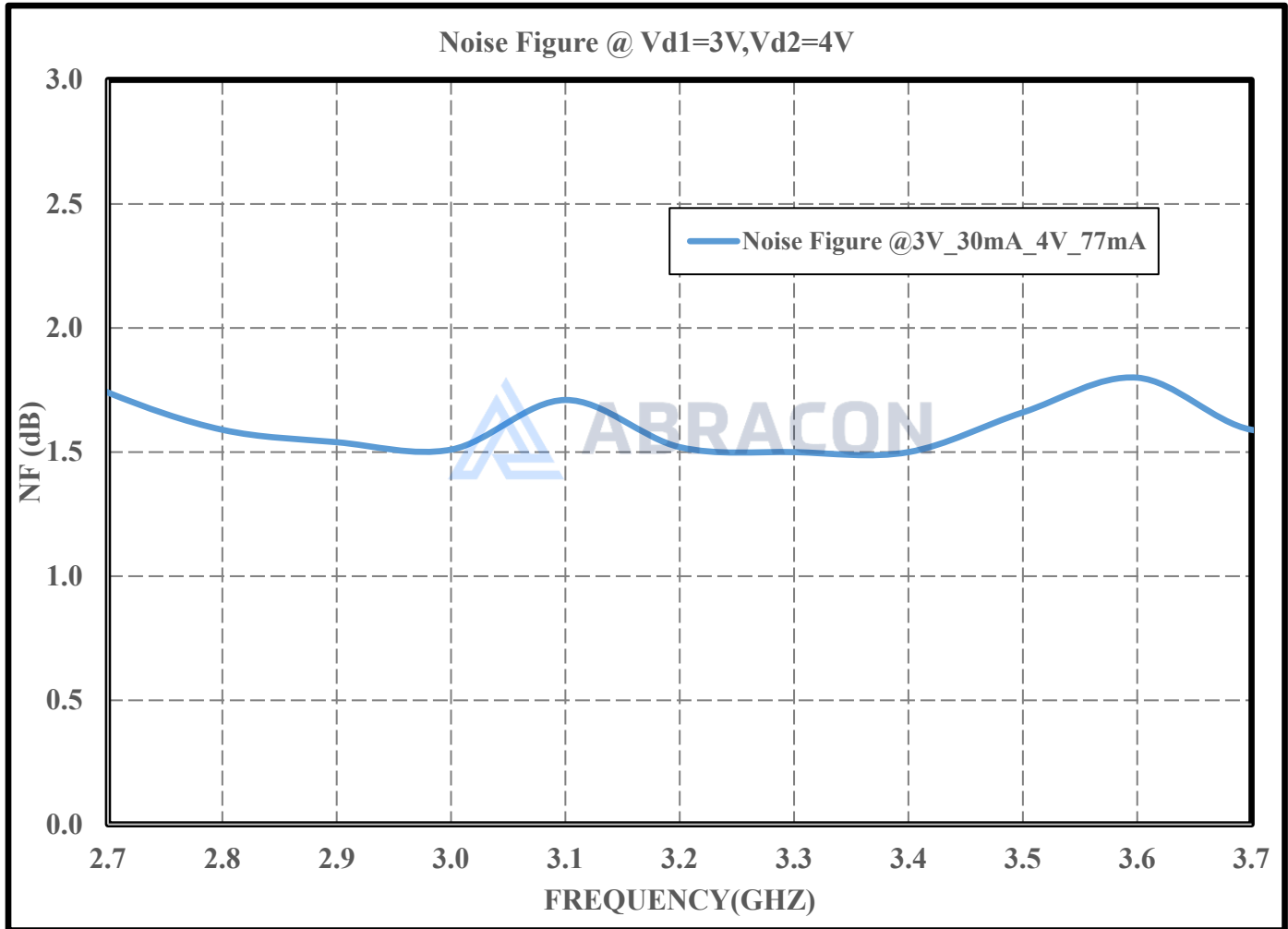

2.7 – 3.7 GHz Low Noise Amplifier

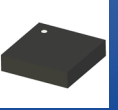

ALND-WB-0009

Request Samples



Check Inventory



5.0 x 5.0 x 1.2 mm
RoHS Compliant

P1dB Vd1=3V, Vd2=4V @3.3GHz

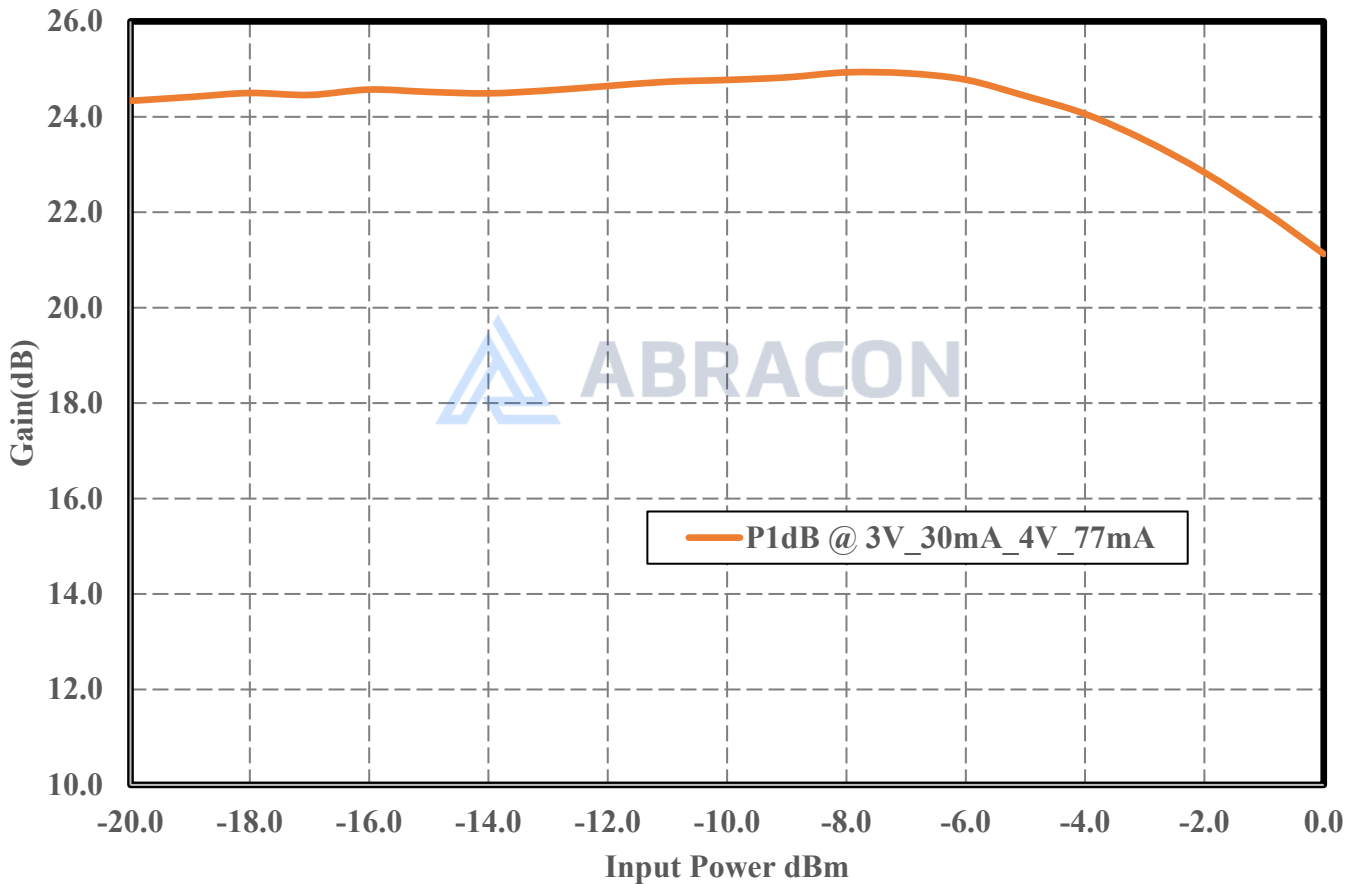

2.7 – 3.7 GHz Low Noise Amplifier

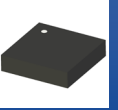

ALND-WB-0009

Request Samples

Check Inventory

5.0 x 5.0 x 1.2 mm
RoHS Compliant

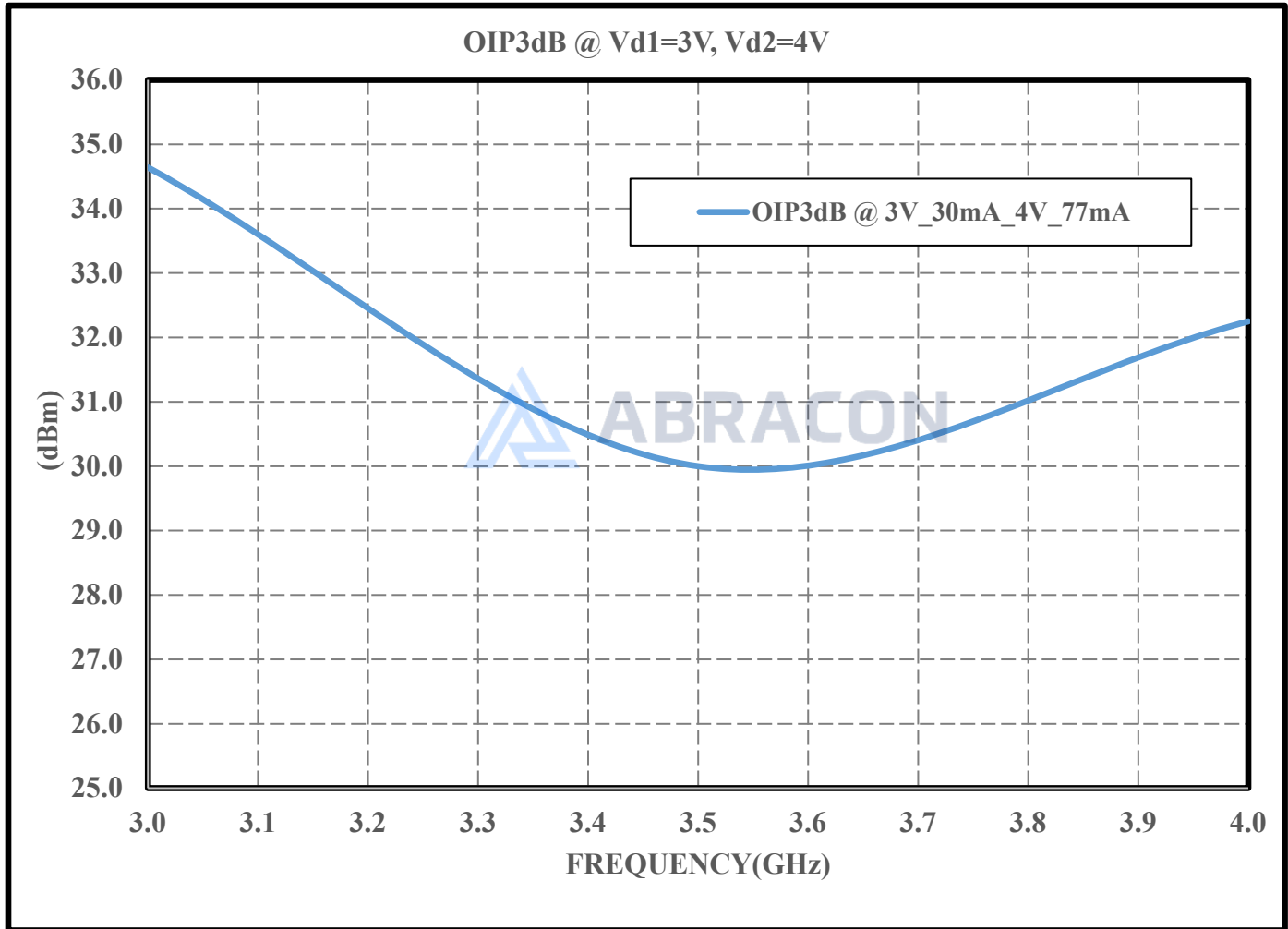

2.7 – 3.7 GHz Low Noise Amplifier



ALND-WB-0009

Request Samples



Check Inventory



5.0 x 5.0 x 1.2 mm
RoHS Compliant

Test Fixture Data Over the temperature

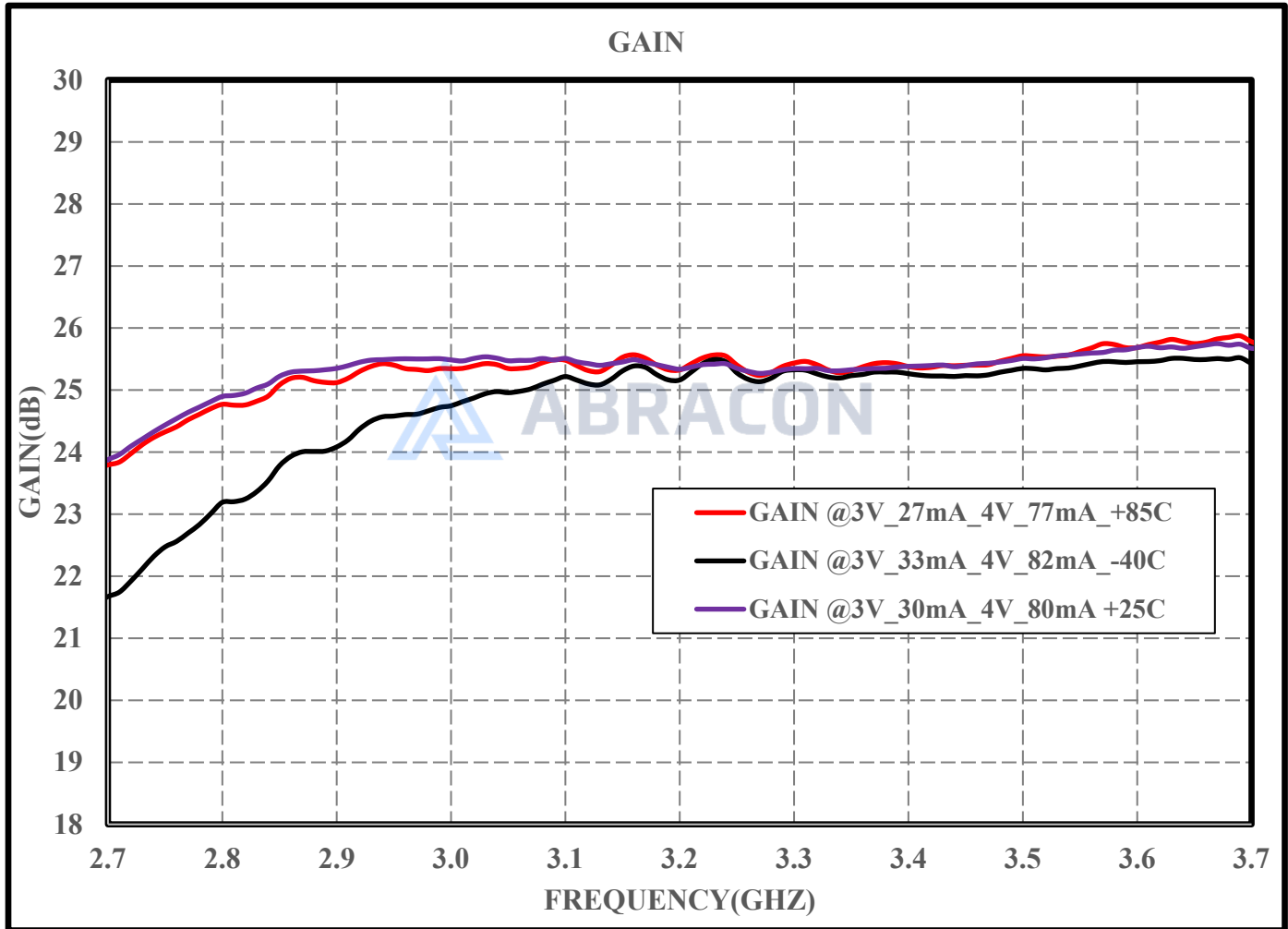

2.7 – 3.7 GHz Low Noise Amplifier

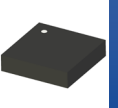

ALND-WB-0009

Request Samples



Check Inventory



5.0 x 5.0 x 1.2 mm
RoHS Compliant

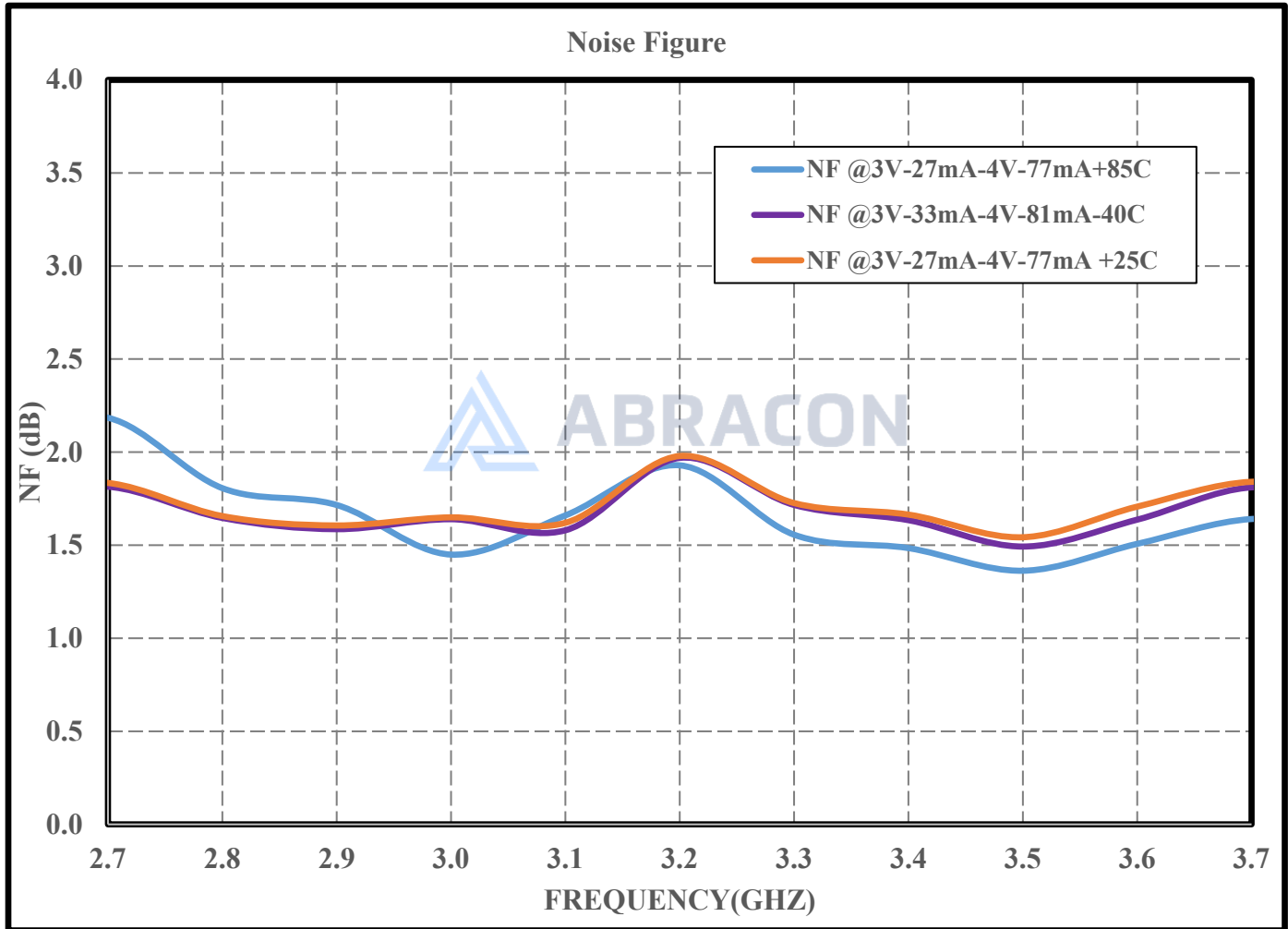

2.7 – 3.7 GHz Low Noise Amplifier

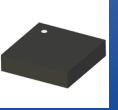

ALND-WB-0009

Request Samples



Check Inventory



5.0 x 5.0 x 1.2 mm
RoHS Compliant

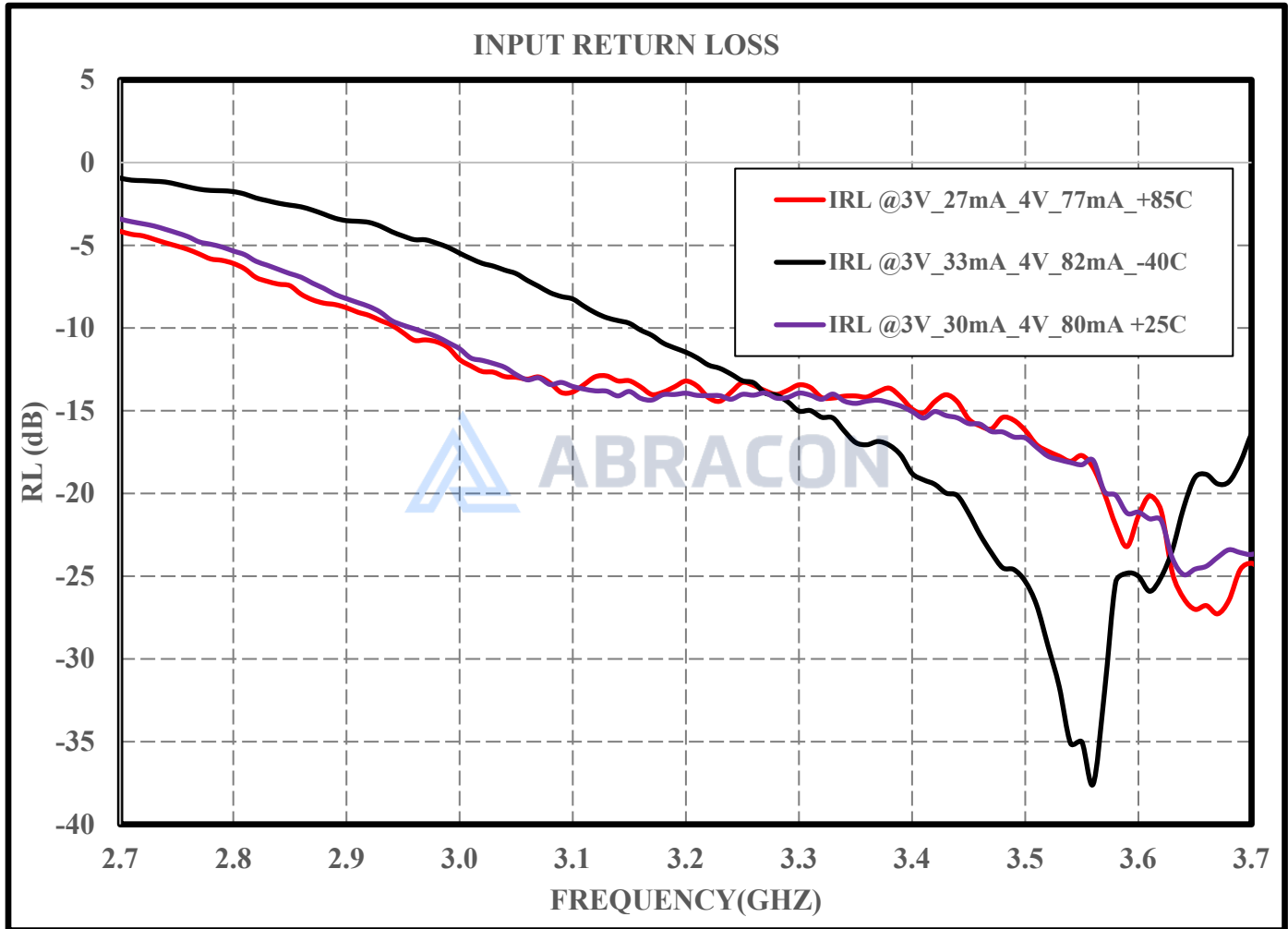

2.7 – 3.7 GHz Low Noise Amplifier

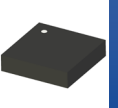

ALND-WB-0009

Request Samples



Check Inventory



5.0 x 5.0 x 1.2 mm
RoHS Compliant

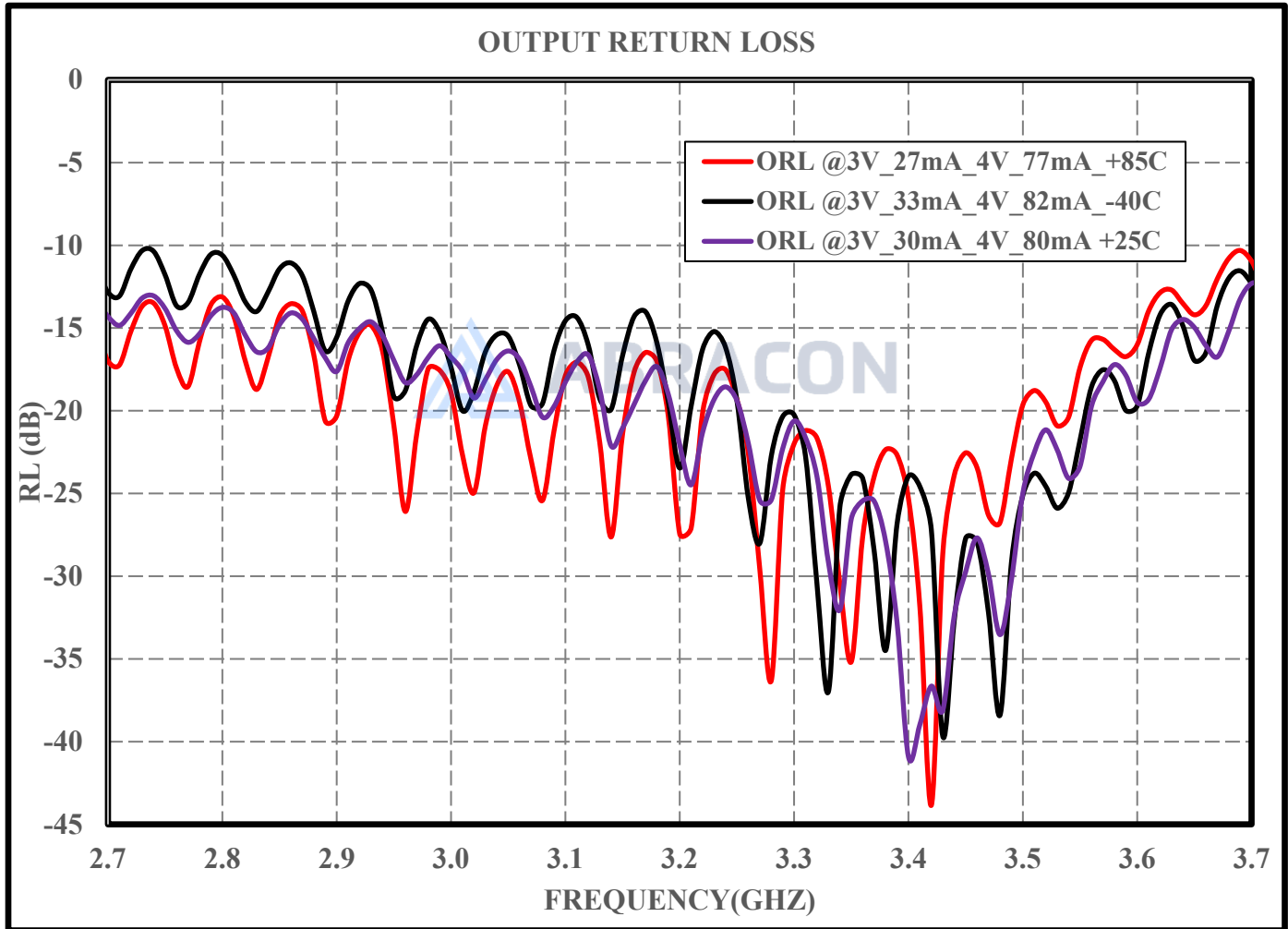

2.7 – 3.7 GHz Low Noise Amplifier

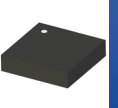

ALND-WB-0009

Request Samples



Check Inventory



5.0 x 5.0 x 1.2 mm
RoHS Compliant

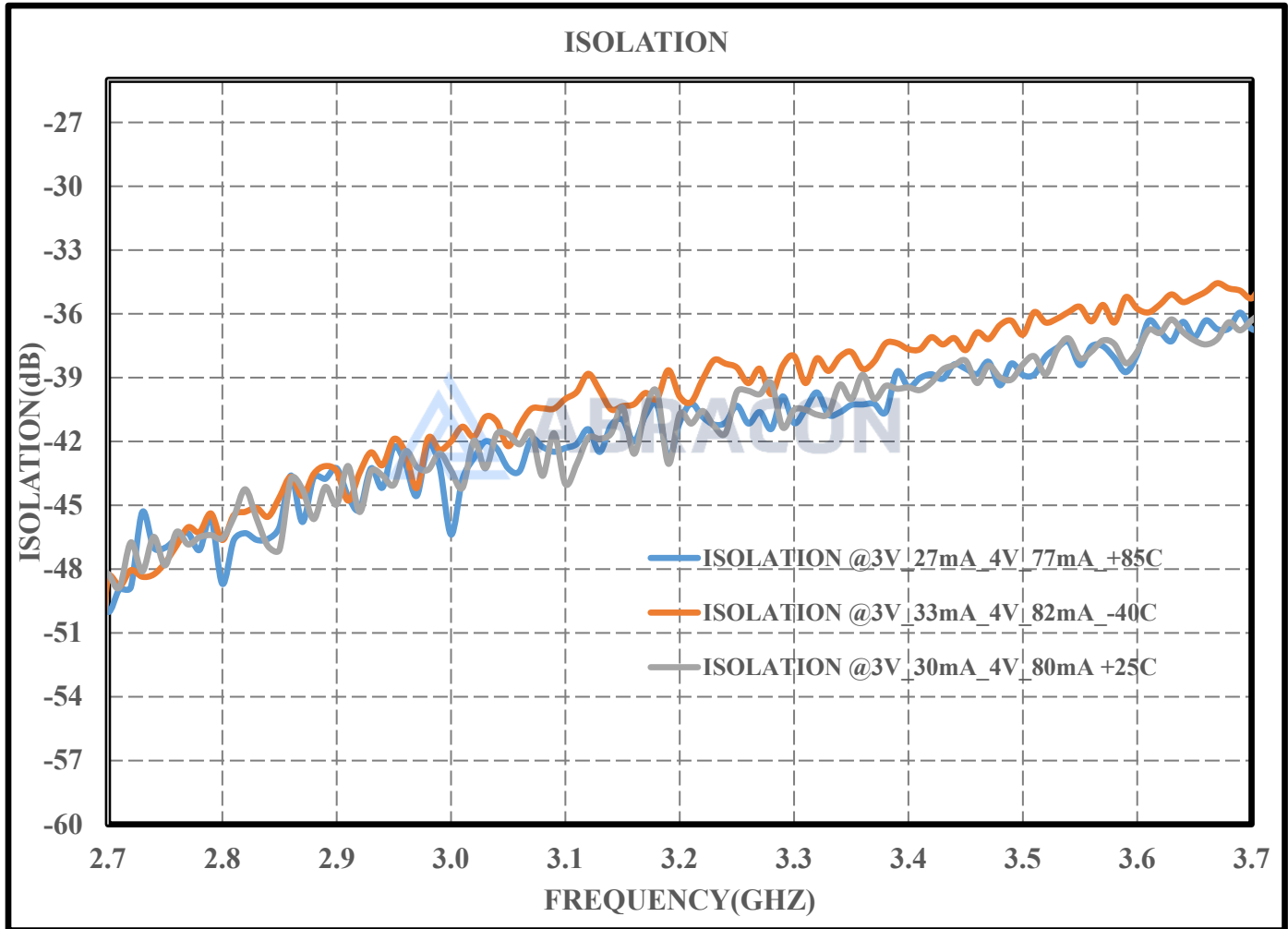

2.7 – 3.7 GHz Low Noise Amplifier

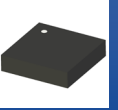

ALND-WB-0009

Request Samples



Check Inventory



5.0 x 5.0 x 1.2 mm
RoHS Compliant

Test Fixture Data Over Different Biasing voltage

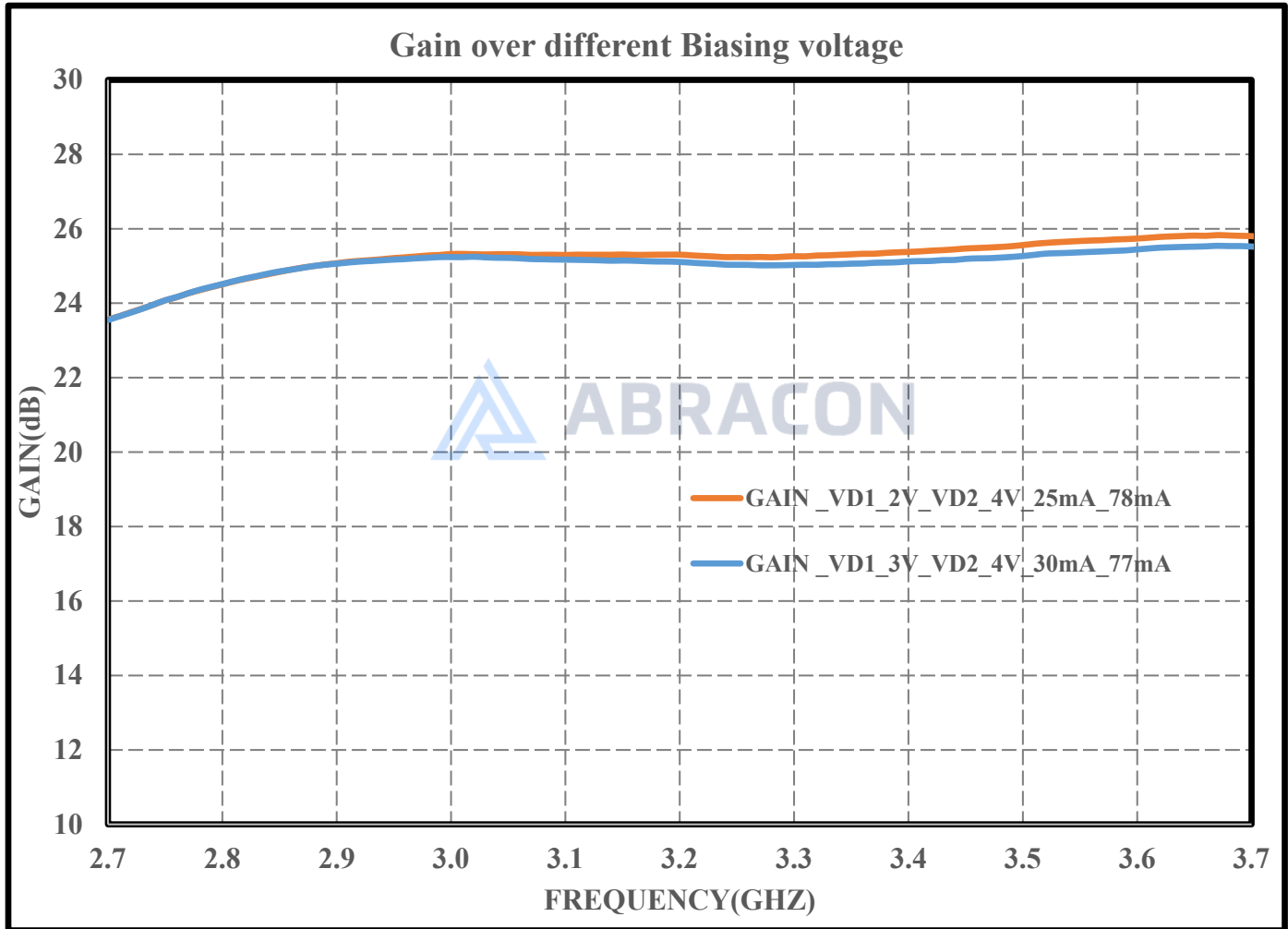

2.7 – 3.7 GHz Low Noise Amplifier

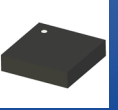

ALND-WB-0009

Request Samples



Check Inventory



5.0 x 5.0 x 1.2 mm
RoHS Compliant

Input Return loss over different Biasing voltage

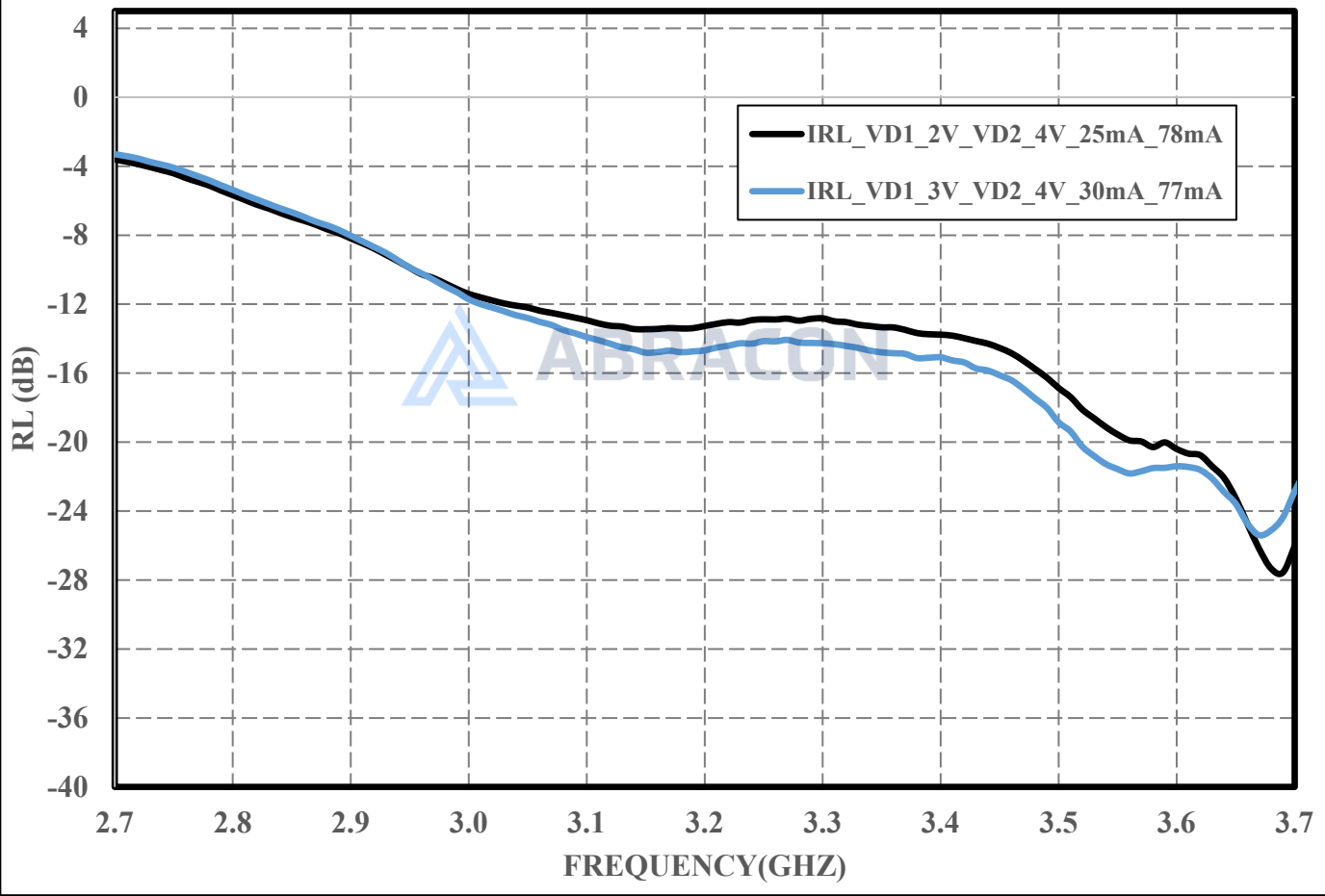

2.7 – 3.7 GHz Low Noise Amplifier

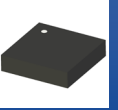

ALND-WB-0009

Request Samples

Check Inventory

5.0 x 5.0 x 1.2 mm
RoHS Compliant

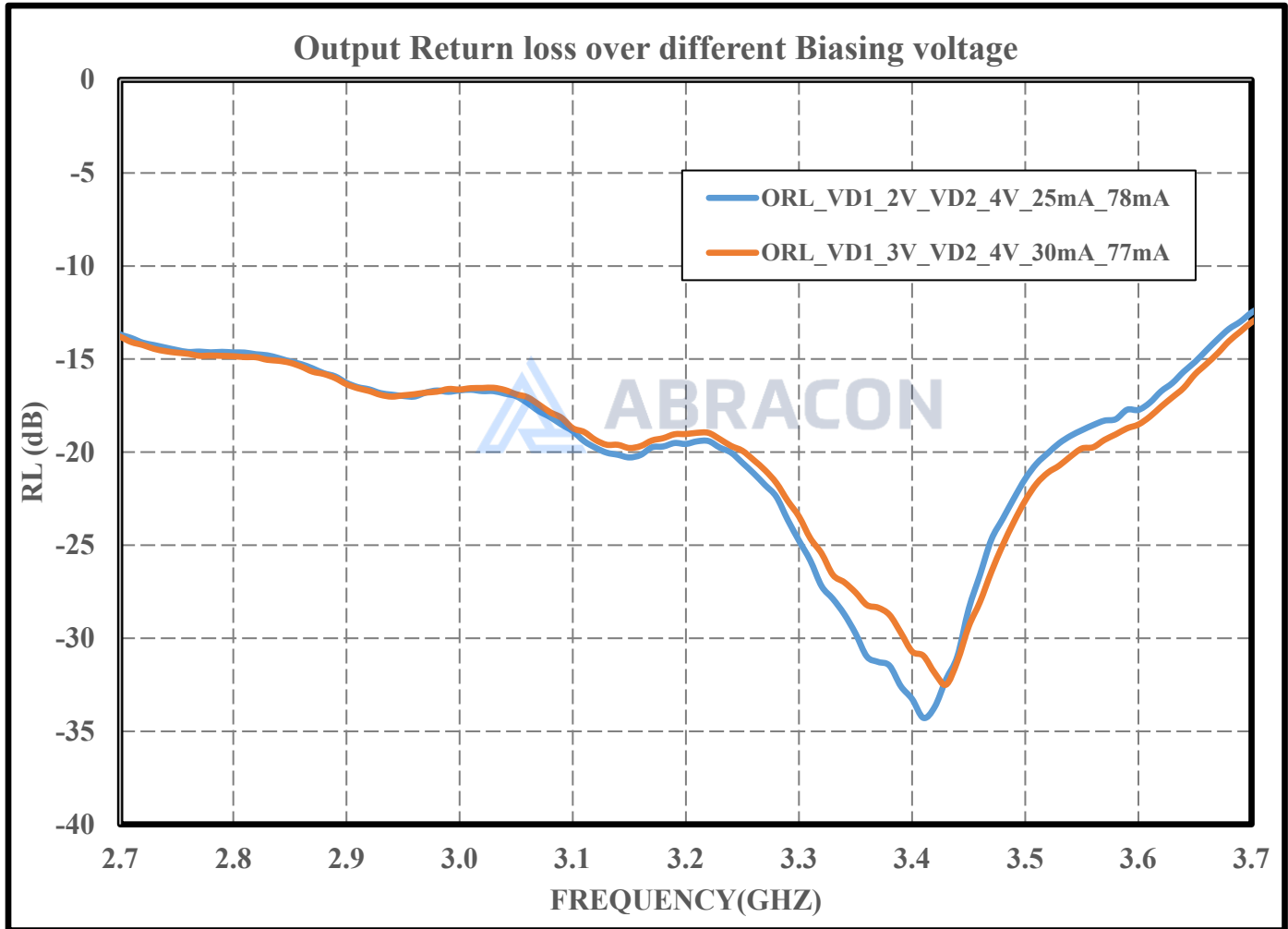

2.7 – 3.7 GHz Low Noise Amplifier

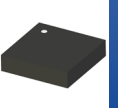

ALND-WB-0009

Request Samples



Check Inventory



5.0 x 5.0 x 1.2 mm
RoHS Compliant

Isolation over different Biasing voltage

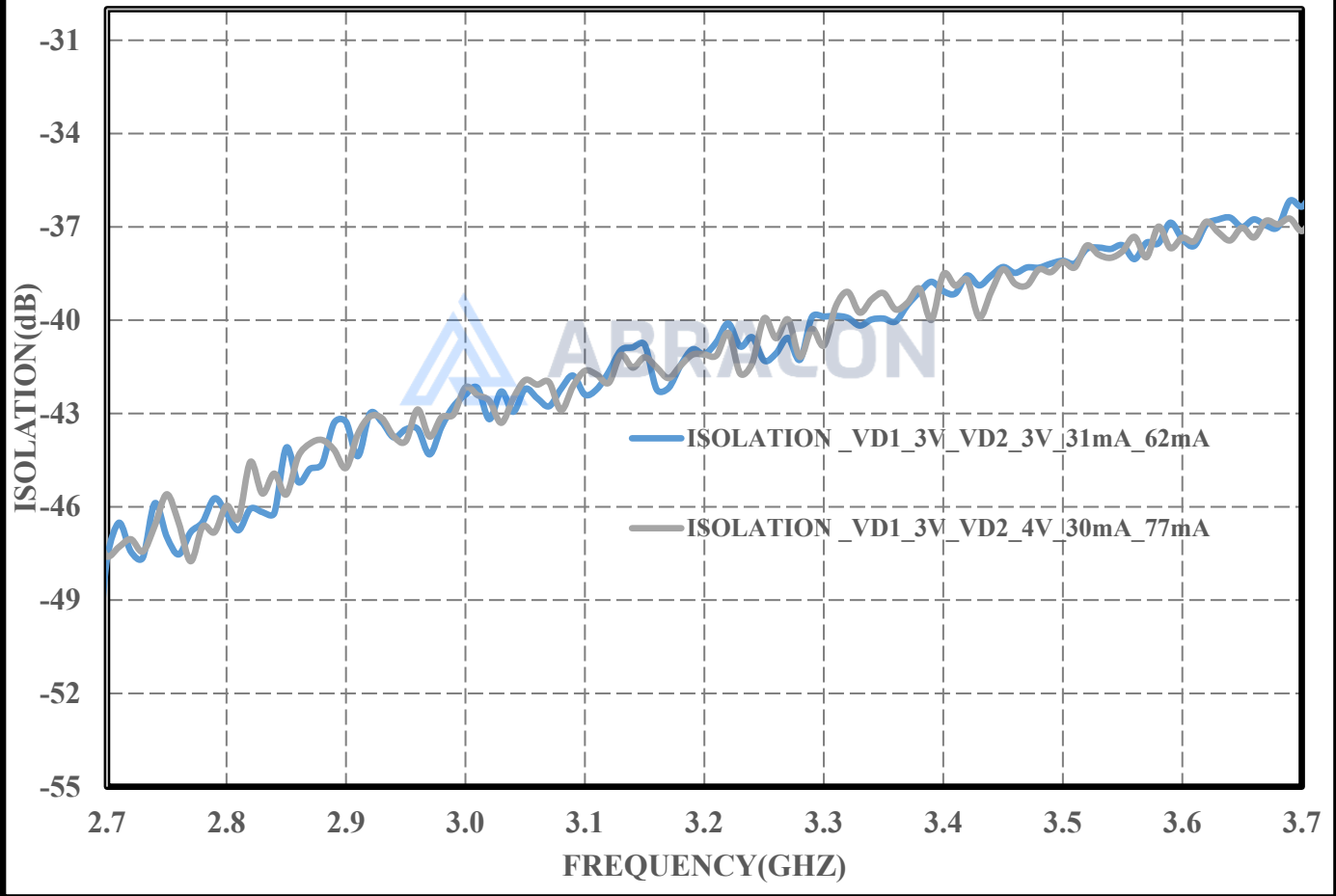

2.7 – 3.7 GHz Low Noise Amplifier

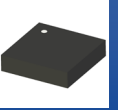

ALND-WB-0009

Request Samples

Check Inventory

5.0 x 5.0 x 1.2 mm
RoHS Compliant

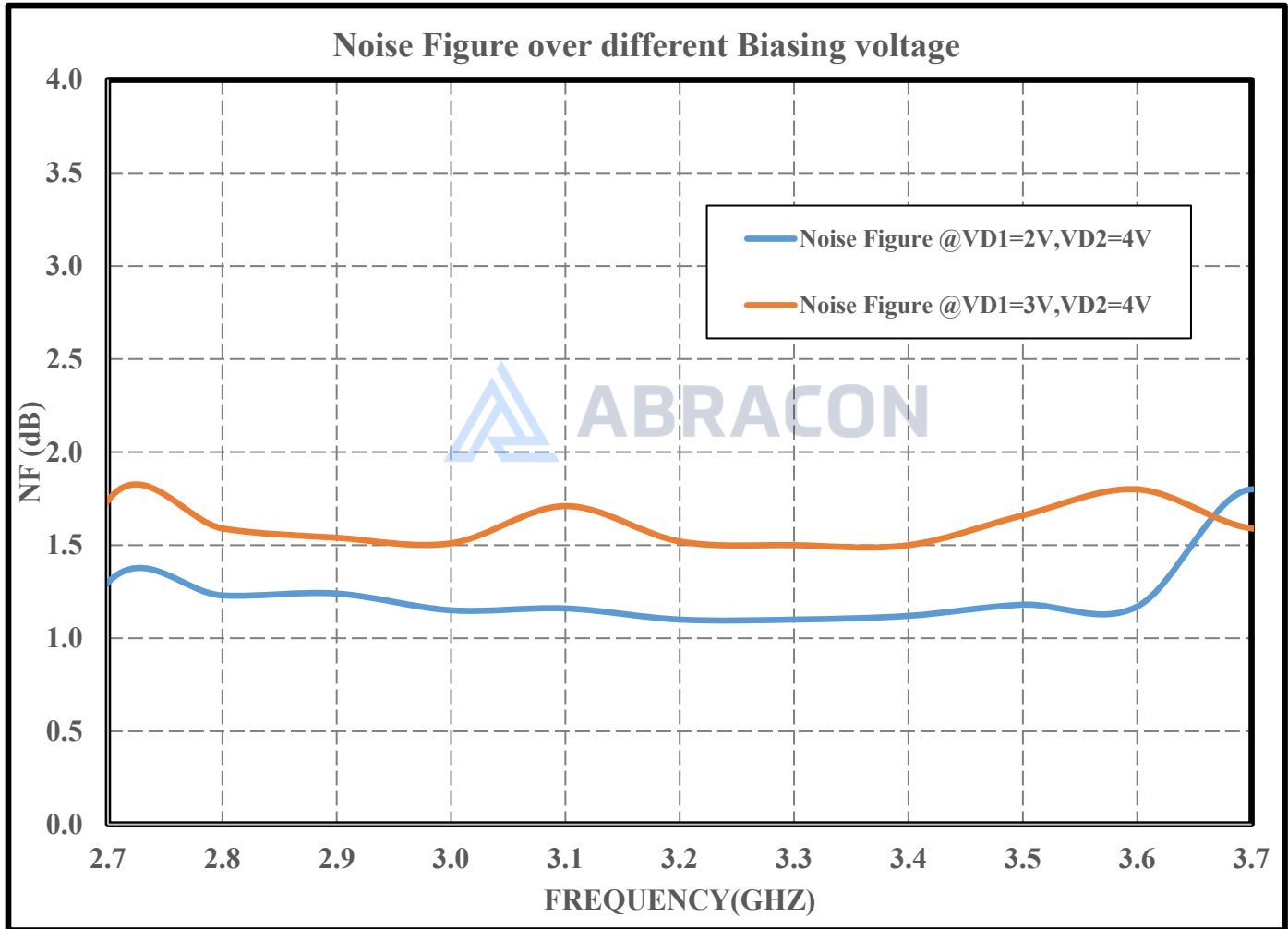

2.7 – 3.7 GHz Low Noise Amplifier

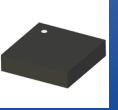

ALND-WB-0009

Request Samples

Check Inventory

5.0 x 5.0 x 1.2 mm
RoHS Compliant

Test Board Pattern

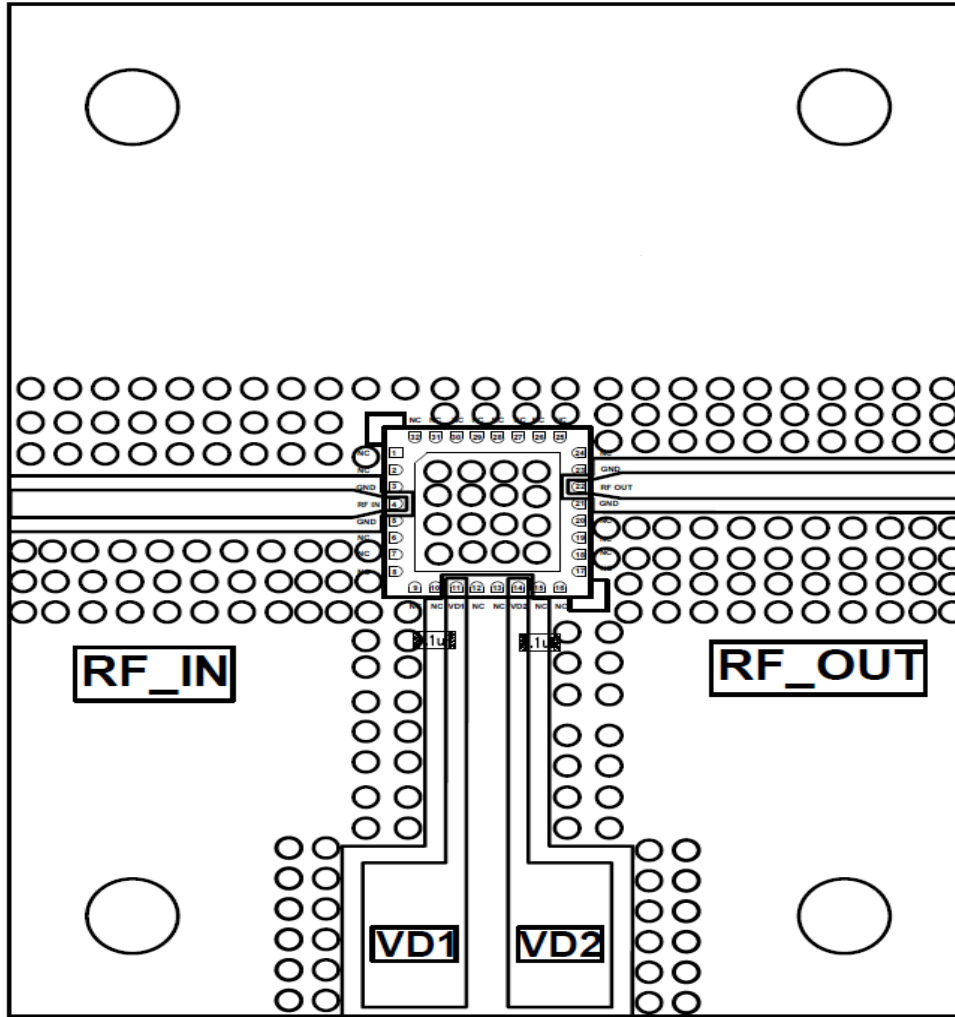

List of components

Capacitor value	Reference
0.1 μ F	0603

Note:

1. Input and output 50-ohm lines are on 10 mil RT duroid substrate
2. 0.1 μ F capacitors may be additionally used as a second level of bypass for reliable Operation.

2.7 – 3.7 GHz Low Noise Amplifier

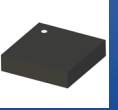

ALND-WB-0009

Request Samples 

Check Inventory 

5.0 x 5.0 x 1.2 mm
RoHS Compliant

Packaging

Packing Tubes

10pcs per tube, 50 tubes per box

ATTENTION: Abracon LLC's products are COTS – Commercial-Off-The-Shelf products; suitable for Commercial, Industrial and, where designated, Automotive Applications. Abracon's products are not specifically designed for Military, Aviation, Aerospace, Life-dependent Medical applications or any application requiring high reliability where component failure could result in loss of life and/or property. For applications requiring high reliability and/or presenting an extreme operating environment, written consent and authorization from Abracon LLC is required. Please contact Abracon LLC for more information.



5101 Hidden Creek Ln Spicewood TX 78669

Phone: 512-371-6159 | Fax: 512-351-8858
For terms and conditions of sales, please visit:
www.abracon.com

REVISED: 07-31-24

ABRACON IS
ISO9001-2015
CERTIFIED