

5G High-Efficiency External Whip Antenna



AETC2303XS-SS

Request Samples



Check Inventory



237 x 39 mm

RoHS/RoHS II Compliant

MSL = N/A

Features

- Supports 617 MHz to 6000 MHz
- VSWR: ≤ 2.0
- Peak Gain: 3.8 dBi
- Efficiency: up to 76%
- SMA or RP-SMA connector

Applications

- Internet of Things (IoT) devices
- LTE-M, Cat M, Cat M1, NB-IoT
- LTE CAT 1 up to CAT 20 supported
- CBRS and 5G bands supported
- Smart Home networking
- Networking & Telecommunication

Product Image



5G High-Efficiency External Whip Antenna



AETC2303XS-SS

Request Samples



Check Inventory



237 x 39 mm

RoHS/RoHS II Compliant

MSL = N/A

Electrical Specification

Parameter	Specification			Unit
Operating Frequency	617-960	1710-2690	2690-6000	MHz
VSWR (Typ.)	< 2.0			
Peak Gain	2.0	3.7	3.8	dBi
Efficiency (Maximum)	76	71	70	%
Impedance	50			Ω
Polarization	Linear			
Radiation Pattern (Azimuth)	Omni-directional			
Input Power (Ambient 25°C)	5			W

Mechanical Specification

Parameter	Specification
Dimensions	237 x 39 mm
Material	ABS ⁽¹⁾
Recommended Torque for Mounting	0.565 N·m
Color	Black
Antenna Type	Whip (Dipole)
RF Connector	SMA(M)
Weight	52 g

(1): UV Resistant optional

Environmental Specification

Parameter	Specification
Operating Temperature	-40°C to +85°C
Storage Temperature	-40°C to +85°C
IP Rating	Optional
RoHS Complaint	Yes



5101 Hidden Creek Ln Spicewood TX 78669
Phone: 512-371-6159 | Fax: 512-351-8858
For terms and conditions of sales, please visit:
www.abracon.com

REVISED: 06-28-23

ABRACON IS
ISO9001-2015
CERTIFIED

5G High-Efficiency External Whip Antenna



AETC2303XS-SS

Request Samples



Check Inventory



237 x 39 mm

RoHS/RoHS II Compliant

MSL = N/A

Ordering Information

Part Number	Description	Connector Option
AETC2303XS-SS	5G High-Efficiency External Whip Antenna with SMA(M) connector	SMA(M)
AETC2303XS-SR	5G High-Efficiency External Whip Antenna with RP-SMA(M) connector	RP-SMA(M)



5101 Hidden Creek Ln Spicewood TX 78669
Phone: 512-371-6159 | Fax: 512-351-8858
For terms and conditions of sales, please visit:
www.abracon.com

REVISED: 06-28-23

ABRACON IS
ISO9001-2015
CERTIFIED

5G High-Efficiency External Whip Antenna



AETC2303XS-SS

Request Samples



Check Inventory



237 x 39 mm

RoHS/RoHS II Compliant

MSL = N/A

Product Dimension

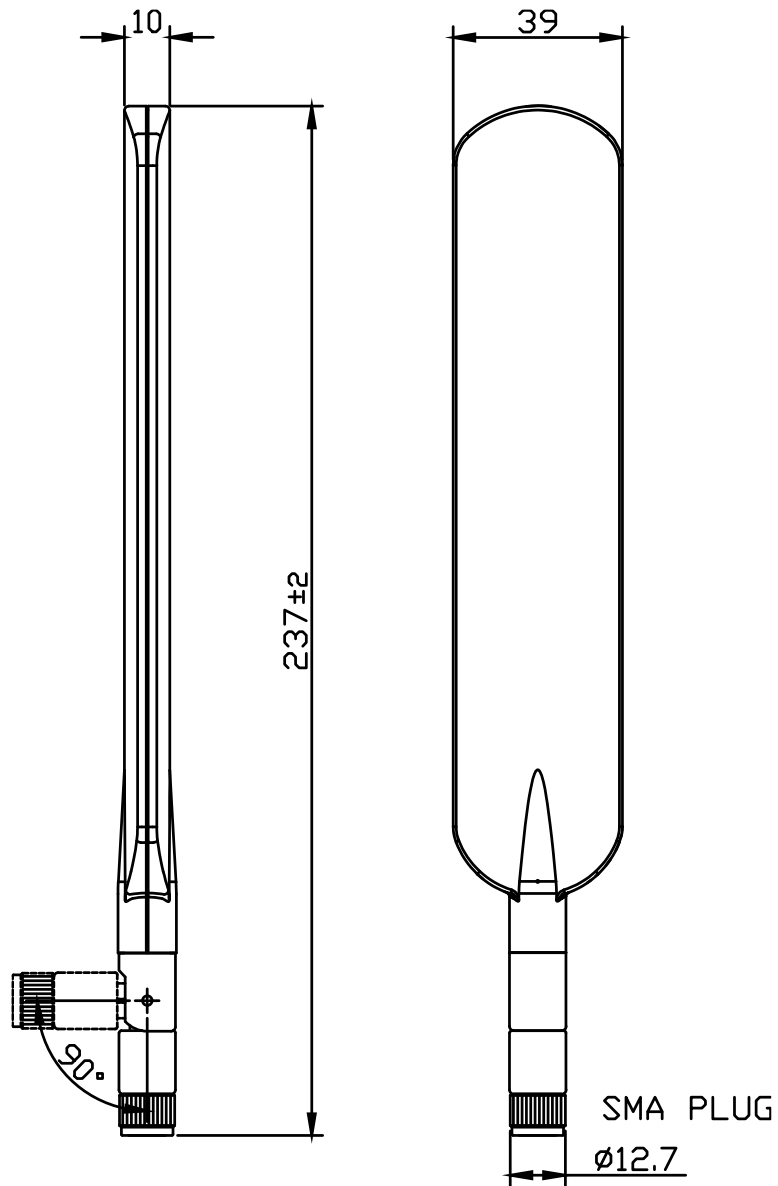

Unit : mm

5G High-Efficiency External Whip Antenna



AETC2303XS-SS

Request Samples



Check Inventory



237 x 39 mm

RoHS/RoHS II Compliant

MSL = N/A

Measurement Setup photo

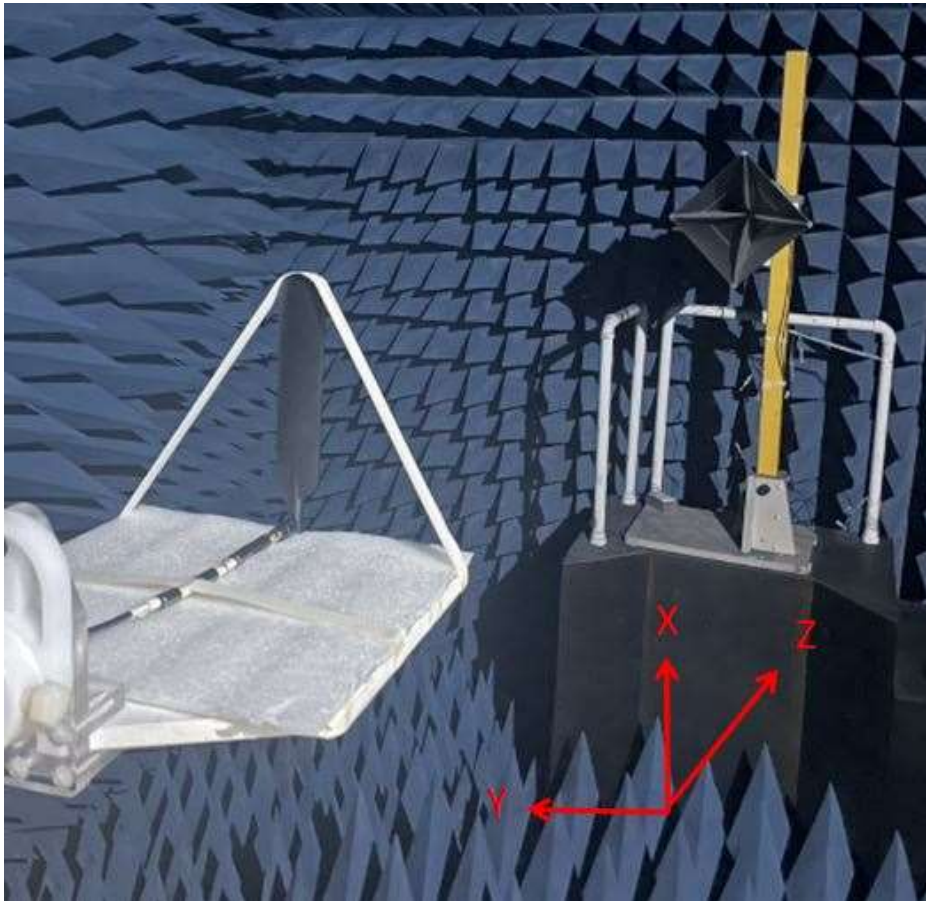

5G High-Efficiency External Whip Antenna



AETC2303XS-SS

Request Samples



Check Inventory



237 x 39 mm

RoHS/RoHS II Compliant

MSL = N/A

Reflection Characteristics –Return Loss & VSWR

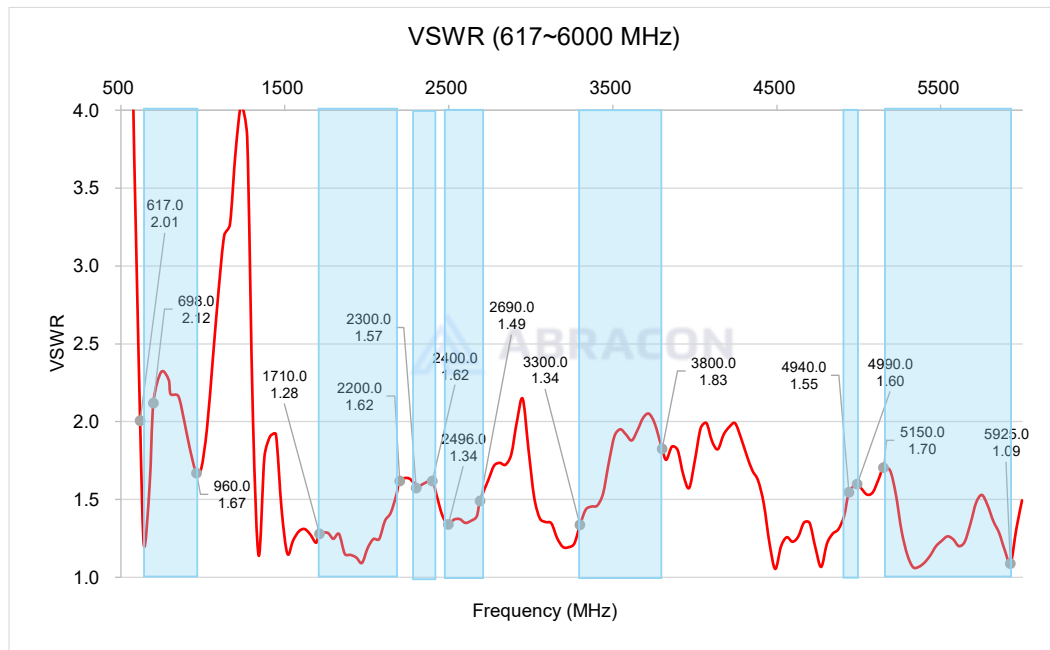
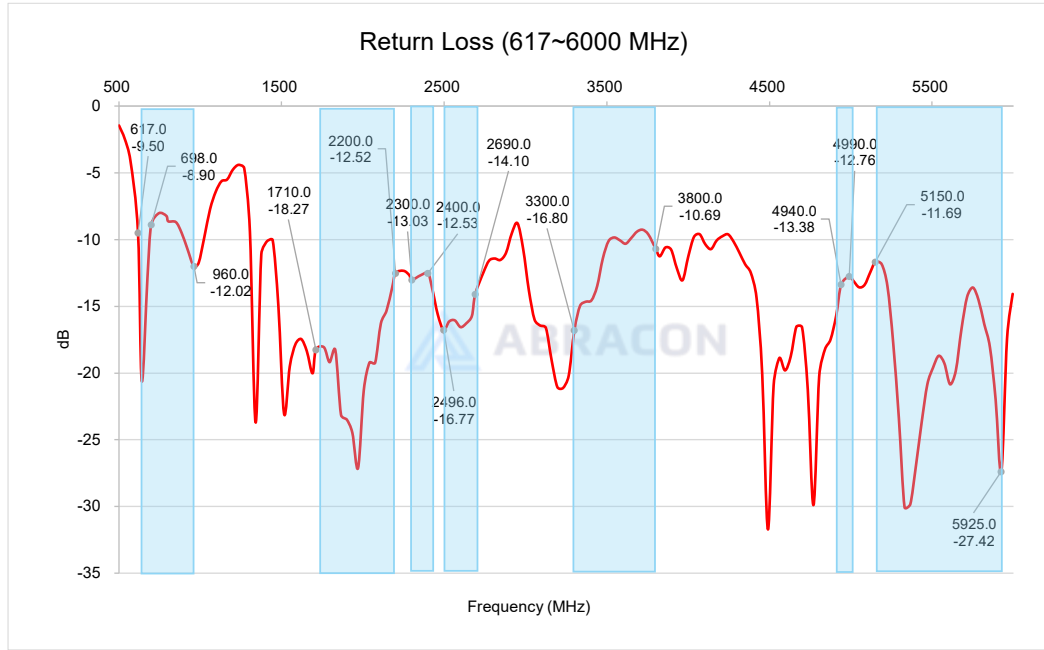

5101 Hidden Creek Ln Spicewood TX 78669
Phone: 512-371-6159 | Fax: 512-351-8858
For terms and conditions of sales, please visit:
www.abracon.com

REVISED: 06-28-23

ABRACON IS
ISO9001-2015
CERTIFIED

5G High-Efficiency External Whip Antenna



AETC2303XS-SS

Request Samples



Check Inventory



237 x 39 mm

RoHS/RoHS II Compliant

MSL = N/A

Radiation Characteristics – Peak Gain

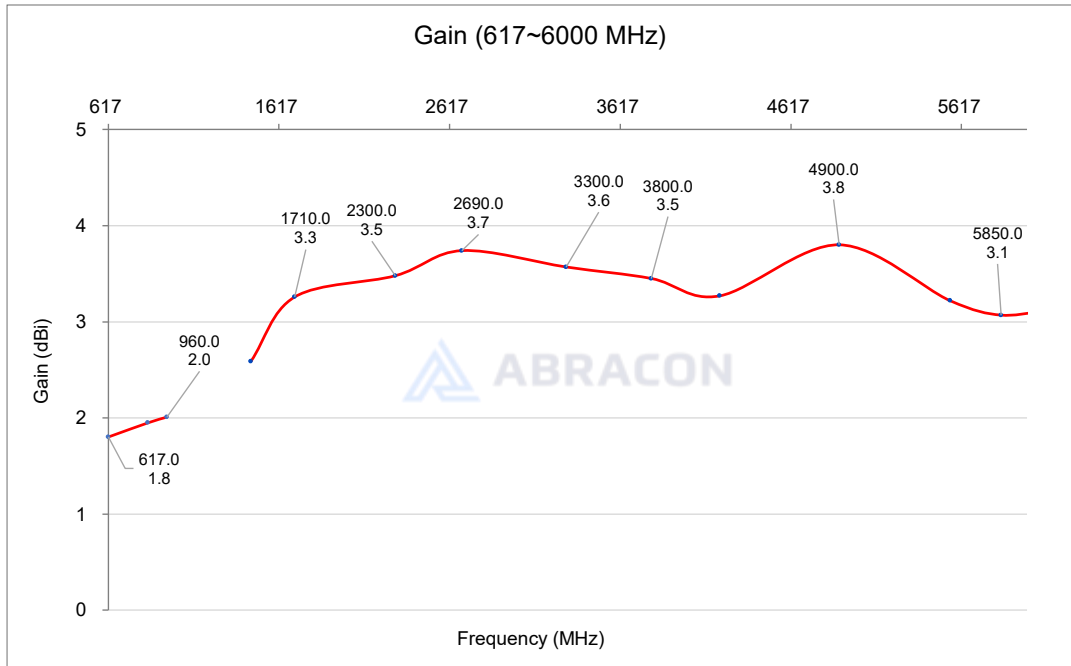

5101 Hidden Creek Ln Spicewood TX 78669
Phone: 512-371-6159 | Fax: 512-351-8858
For terms and conditions of sales, please visit:
www.abracon.com

REVISED: 06-28-23

ABRACON IS
ISO9001-2015
CERTIFIED

5G High-Efficiency External Whip Antenna



AETC2303XS-SS

Request Samples



Check Inventory



237 x 39 mm

RoHS/RoHS II Compliant

MSL = N/A

Radiation Characteristics – Total Efficiency (%)

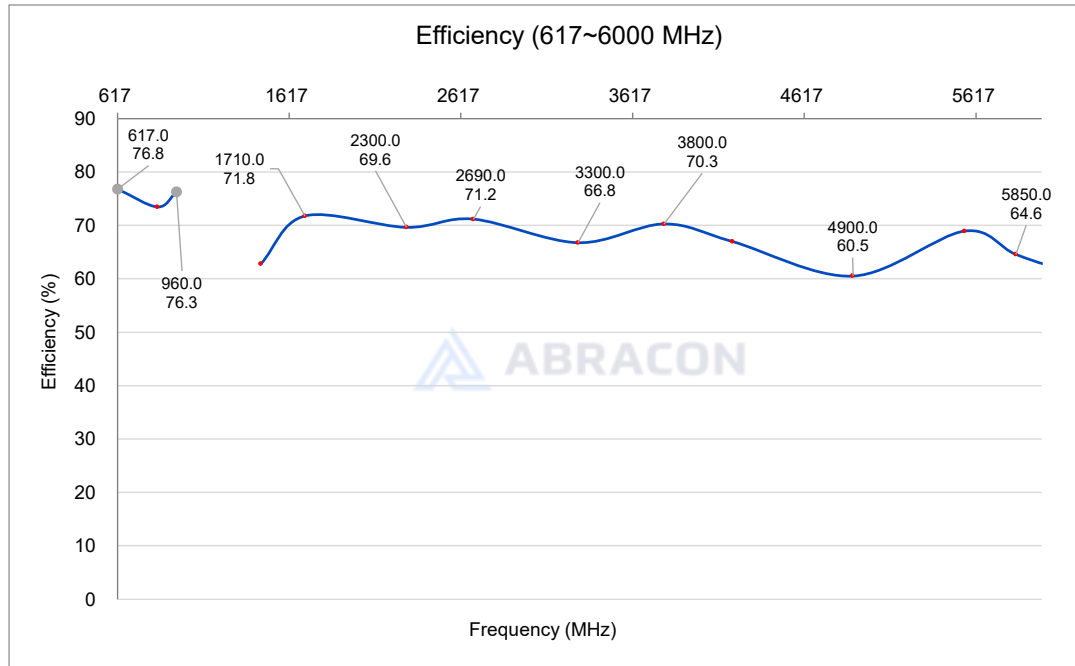

5G High-Efficiency External Whip Antenna



AETC2303XS-SS

Request Samples



Check Inventory



237 x 39 mm

RoHS/RoHS II Compliant

MSL = N/A

Radiation Characteristics – 3D & 2D Pattern

617MHz

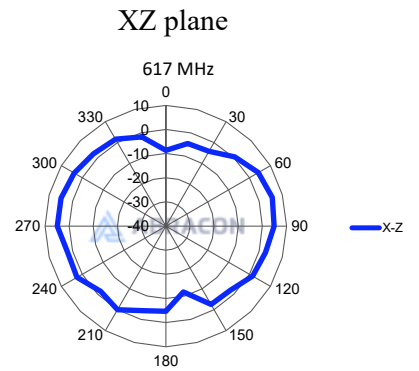
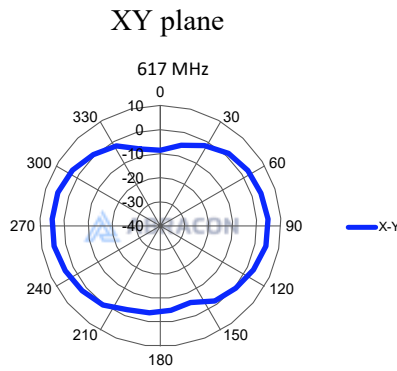
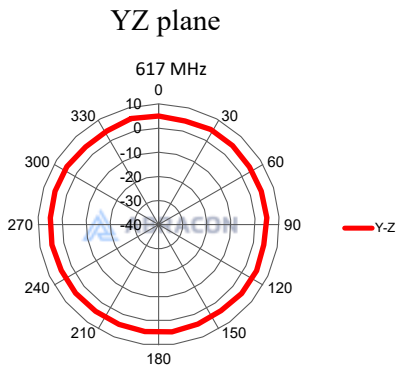
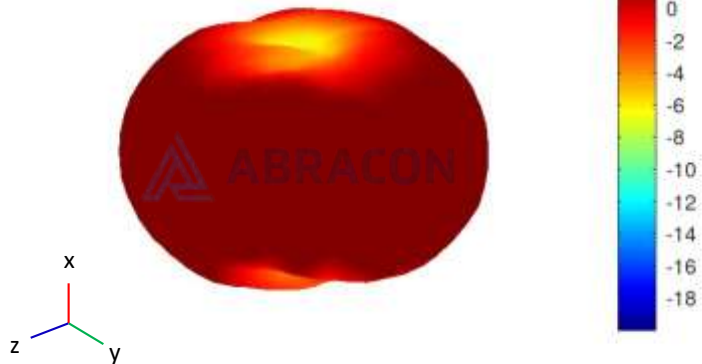

5G High-Efficiency External Whip Antenna



AETC2303XS-SS

Request Samples



Check Inventory



237 x 39 mm

RoHS/RoHS II Compliant

MSL = N/A

700MHz

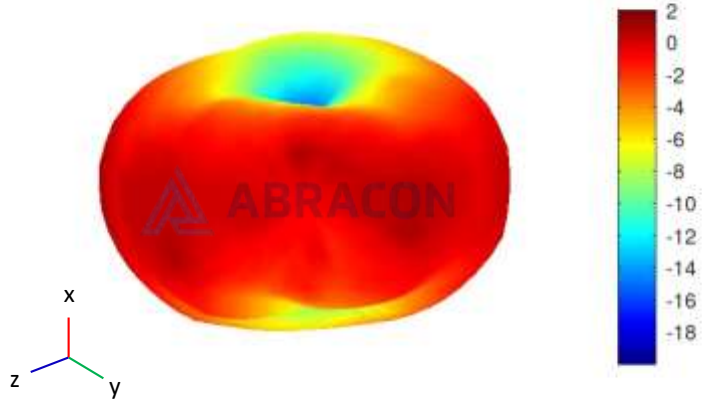

YZ plane

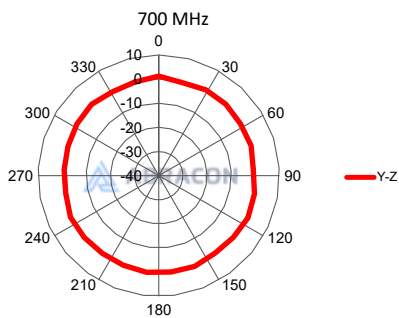

XY plane

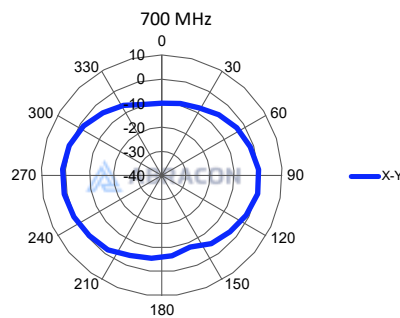

XZ plane

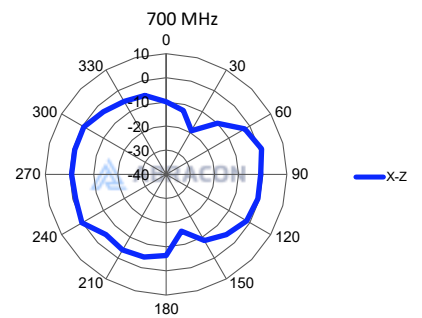

5G High-Efficiency External Whip Antenna



AETC2303XS-SS

Request Samples



Check Inventory



237 x 39 mm

RoHS/RoHS II Compliant

MSL = N/A

960MHz

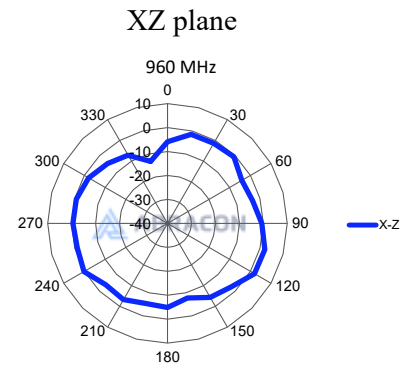
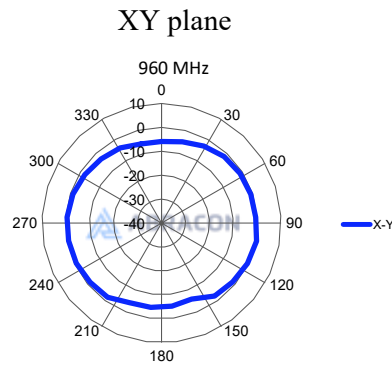
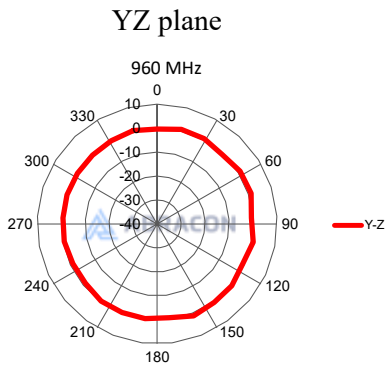
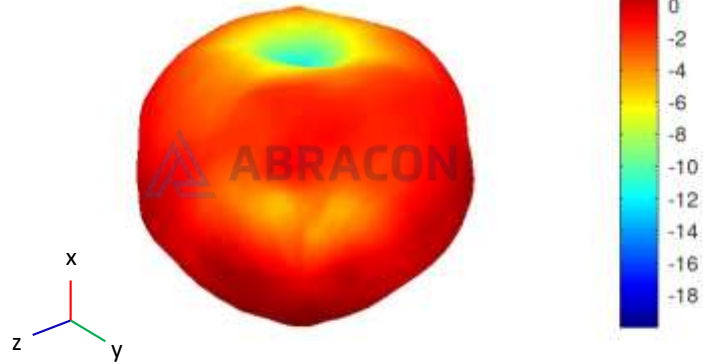

5G High-Efficiency External Whip Antenna



AETC2303XS-SS

Request Samples



Check Inventory



237 x 39 mm

RoHS/RoHS II Compliant

MSL = N/A

1710MHz

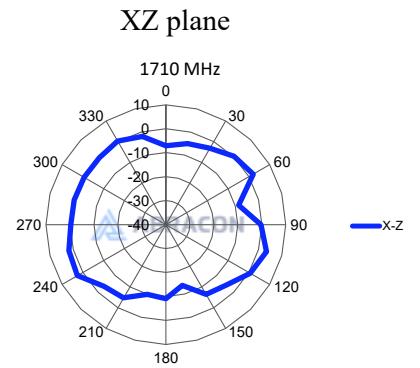
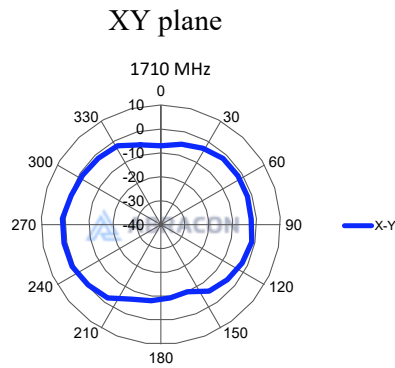
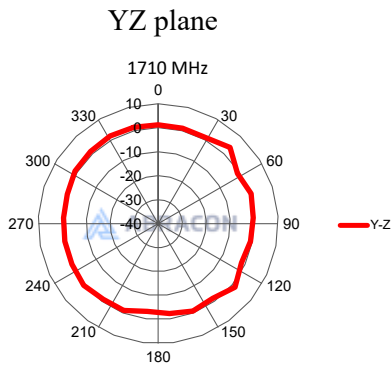
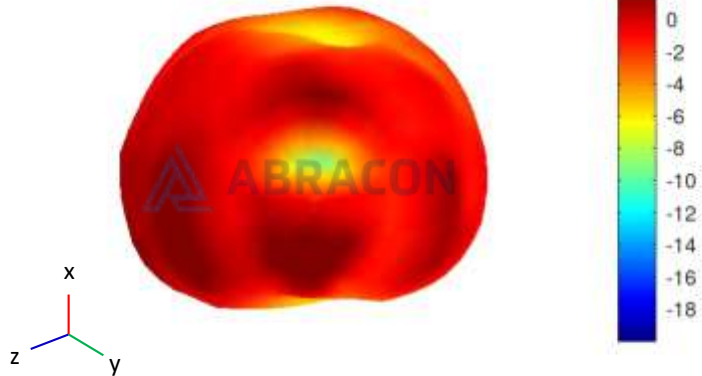

5G High-Efficiency External Whip Antenna



AETC2303XS-SS

Request Samples



Check Inventory



237 x 39 mm

RoHS/RoHS II Compliant

MSL = N/A

2000MHz

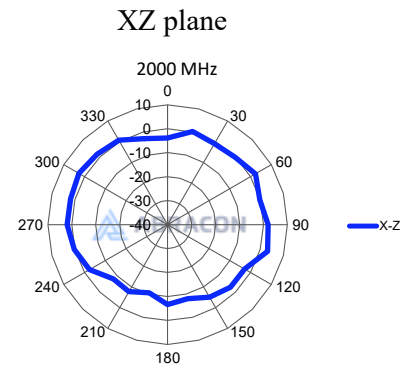
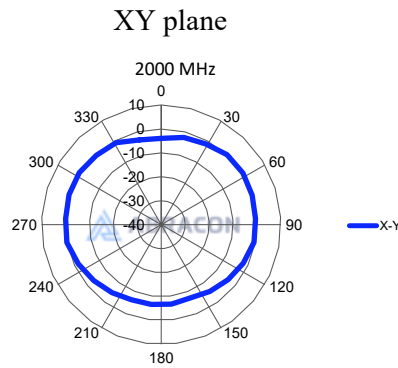
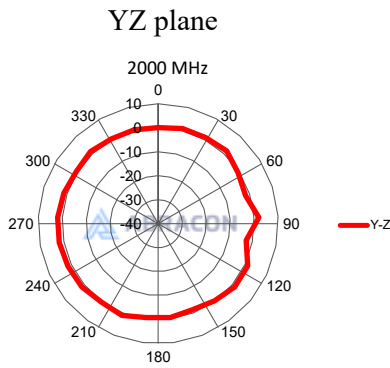

5G High-Efficiency External Whip Antenna



AETC2303XS-SS

Request Samples



Check Inventory



237 x 39 mm

RoHS/RoHS II Compliant

MSL = N/A

2500MHz

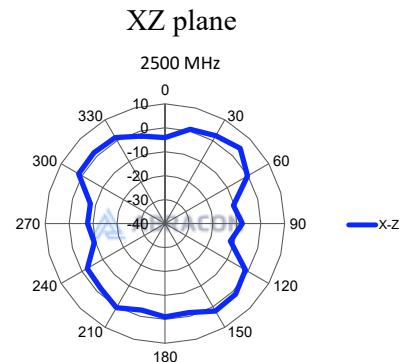
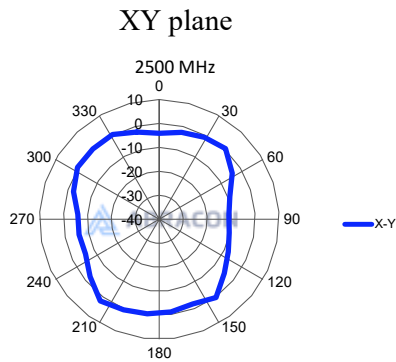
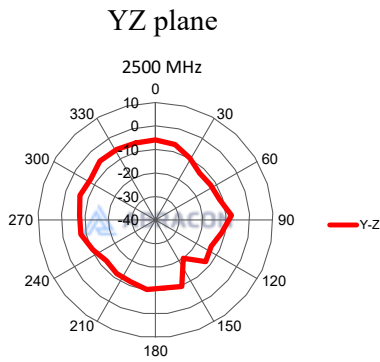
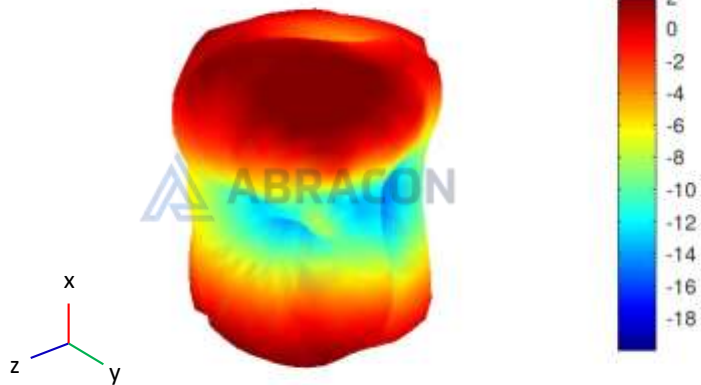

5G High-Efficiency External Whip Antenna



AETC2303XS-SS

Request Samples



Check Inventory



237 x 39 mm

RoHS/RoHS II Compliant

MSL = N/A

2690MHz

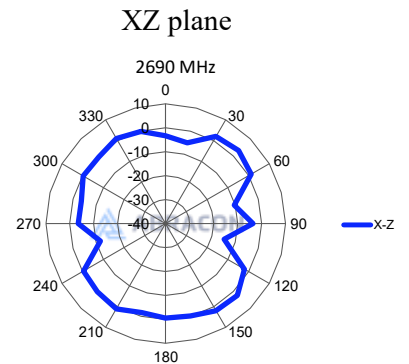
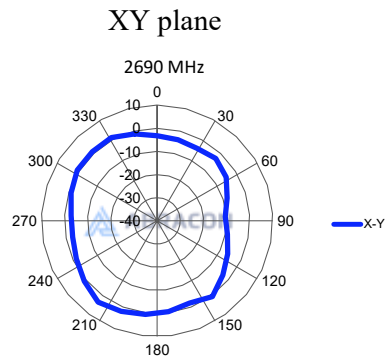
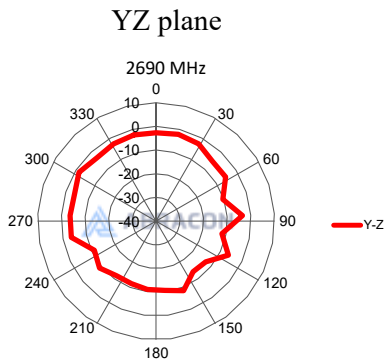
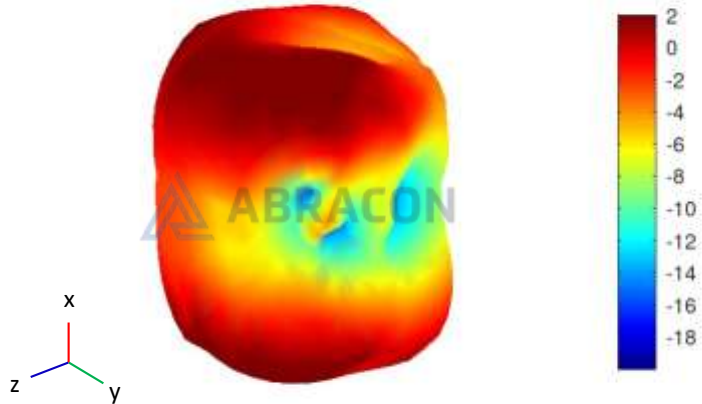

5G High-Efficiency External Whip Antenna



AETC2303XS-SS

Request Samples



Check Inventory



237 x 39 mm

RoHS/RoHS II Compliant

MSL = N/A

3600MHz

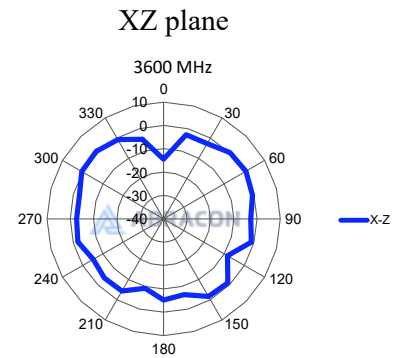
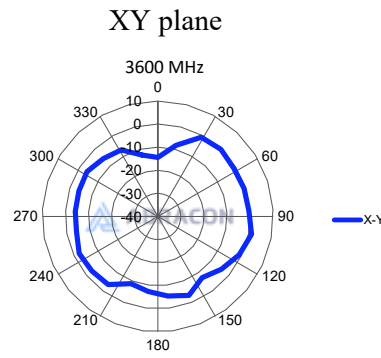
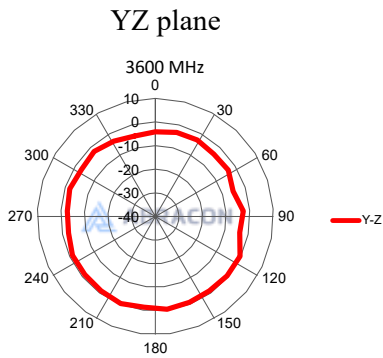
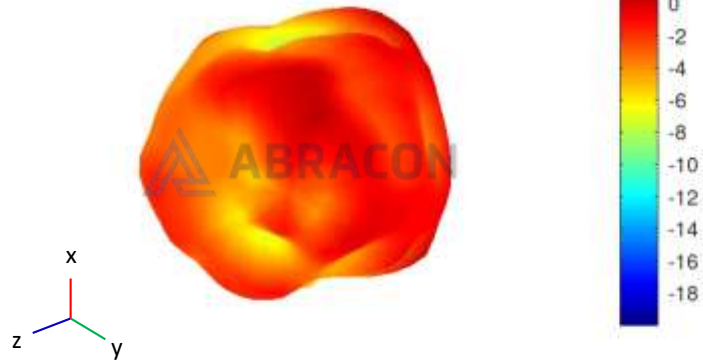

5G High-Efficiency External Whip Antenna



AETC2303XS-SS

Request Samples



Check Inventory



237 x 39 mm

RoHS/RoHS II Compliant

MSL = N/A

5250MHz

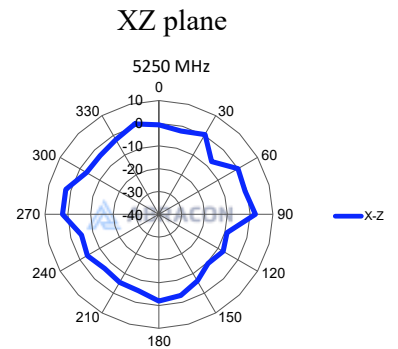
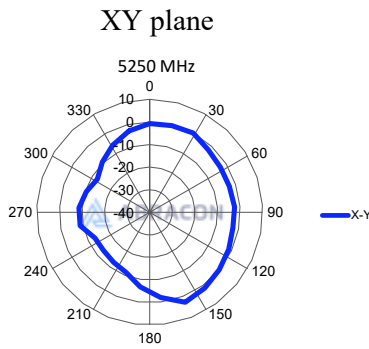
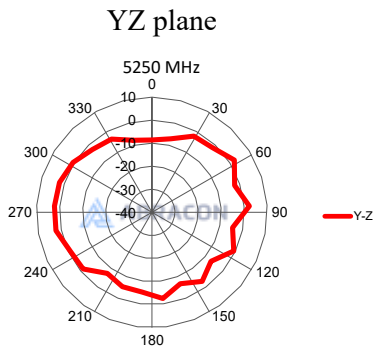
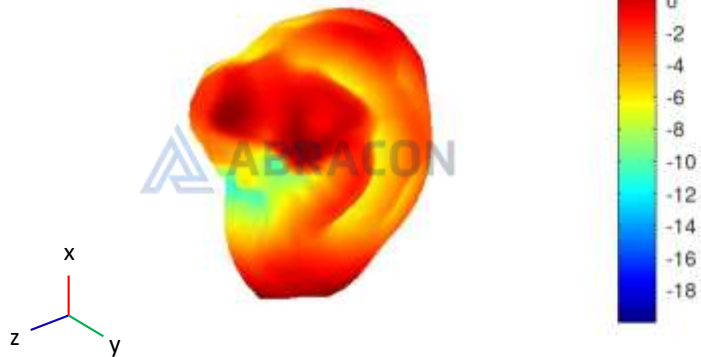

5G High-Efficiency External Whip Antenna



AETC2303XS-SS

Request Samples



Check Inventory



237 x 39 mm

RoHS/RoHS II Compliant

MSL = N/A

5850MHz

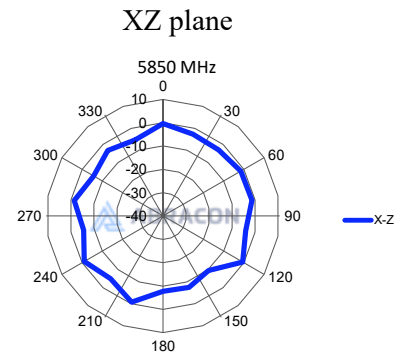
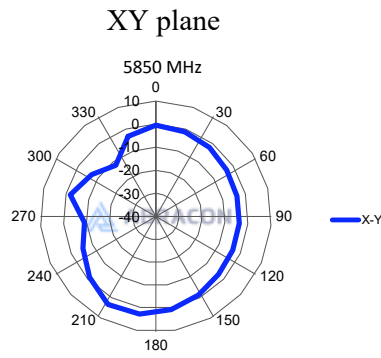
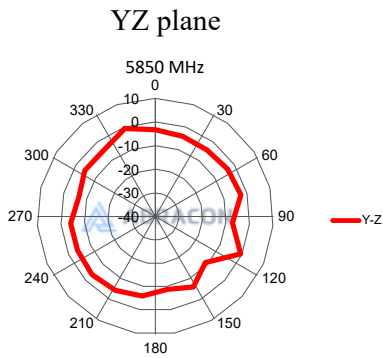
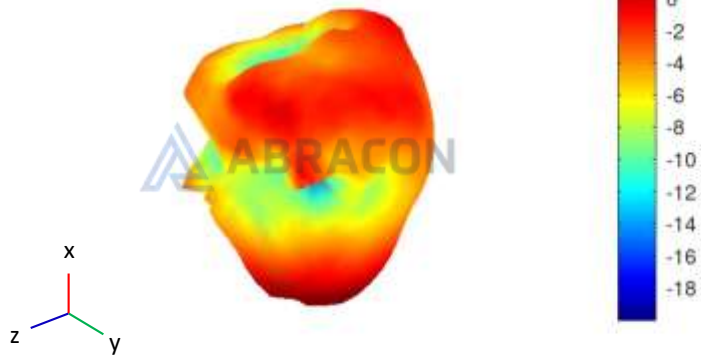

5G High-Efficiency External Whip Antenna



AETC2303XS-SS

Request Samples



Check Inventory



237 x 39 mm

RoHS/RoHS II Compliant

MSL = N/A

Packaging

Number of antennas / PE bag: 25 pcs

Number of PE bags / carton: 8

Total antennas / carton: 200 pcs

ATTENTION: Abracon LLC's products are COTS – Commercial-Off-The-Shelf products; suitable for Commercial, Industrial and, where designated, Automotive Applications. Abracon's products are not specifically designed for Military, Aviation, Aerospace, Life-dependent Medical applications or any application requiring high reliability where component failure could result in loss of life and/or property. For applications requiring high reliability and/or presenting an extreme operating environment, written consent and authorization from Abracon LLC is required. Please contact Abracon LLC for more information.



5101 Hidden Creek Ln Spicewood TX 78669
Phone: 512-371-6159 | Fax: 512-351-8858
For terms and conditions of sales, please visit:
www.abracon.com

REVISED: 06-28-23

ABRACON IS
ISO9001-2015
CERTIFIED