

Mini LTCC RF Diplexer for Bluetooth, Wi-Fi, UWB



ADID-R-0016

Request Samples



Check Inventory



1.6 x 0.8 x 0.6 mm
RoHS Compliant

Features

- Supporting 2400~2500 / 6200~8200 MHz Simultaneously
- Small Form Factor 1.6 x 0.8 x 0.6 mm
- Low Insertion Loss 1.0 dB
- High Isolation Between Bands
- Temperature Stability Across Wide Temperature Bands
- High-Power Handling up to 3W
- RoHS Compliant

Applications

- Ultra-Wide Band (UWB) Modules
- AR/VR Headsets
- Indoor Positioning
- Real-Time Location Systems (RTLS)
- Ultra-Wide Band Communications
- UWB Radar
- Secure Authentication

Product Image

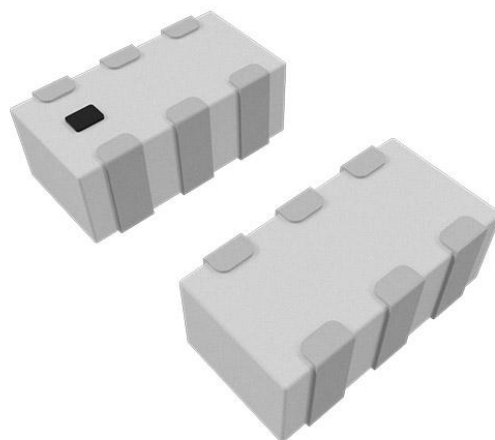

Mini LTCC RF Diplexer for Bluetooth, Wi-Fi, UWB



ADID-R-0016

Request Samples



Check Inventory



1.6 x 0.8 x 0.6 mm
RoHS Compliant

Electrical Specifications

Parameters	Specification		Units	Notes
Passband	2400-2500	6200-8200 (UWB channels 5-9)	MHz	
Insertion Loss	0.7	1.0	dB	@25°C
	1.0	1.3		@-40°C ~ +85°C
VSWR	< 2.0		-	
Attenuation (min.)	20	-	dB	4800 ~ 5000 MHz
	20	-		6200 ~ 8500 MHz
	-	25		2400 ~ 2500 MHz
	-	22		12400 ~ 16400 MHz
Group Delay			ns	
Group Delay Ripple			ns	
Isolation (min.)	25		dB	2400 ~ 2500 MHz
	22			6200 ~ 8500 MHz
Power Capacity	2.0		W	-

Mechanical Specifications

Parameters	Specifications
Filter Dimension	1.6 x 0.8 x 0.6 mm
Mounting Type	Surface Mount

Environmental Specifications

Parameters	Specifications
Operating Temperature	-40°C ~ +105°C
Storage Temperature	-10°C ~ +40°C (70% R.H. max)
Humidity	90% - 95% R.H.



5101 Hidden Creek Ln Spicewood TX 78669
 Phone: 512-371-6159 | Fax: 512-351-8858
 For terms and conditions of sales, please visit:
www.abracon.com

REVISED: 01-15-25

ABRACON IS
 ISO9001-2015
 CERTIFIED

Mini LTCC RF Diplexer for Bluetooth, Wi-Fi, UWB



ADID-R-0016

Request Samples



Check Inventory



1.6 x 0.8 x 0.6 mm
RoHS Compliant

Ordering Information

Part Number	Description
ADID-R-0016	Mini LTCC RF Diplexer for Bluetooth, Wi-Fi, UWB on Cut Tape
ADID-R-0016-T	Mini LTCC RF Diplexer for Bluetooth, Wi-Fi, UWB on Tap & Reel
ADID-R-0016-EVB	Mini LTCC RF Diplexer for Bluetooth, Wi-Fi, UWB EVB

Note: Other options not listed may be available upon request via [Abracon online support](#)

Mini LTCC RF Diplexer for Bluetooth, Wi-Fi, UWB

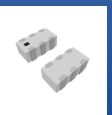

ADID-R-0016

Request Samples



Check Inventory



1.6 x 0.8 x 0.6 mm
RoHS Compliant

Package Dimensions & PCB Footprint

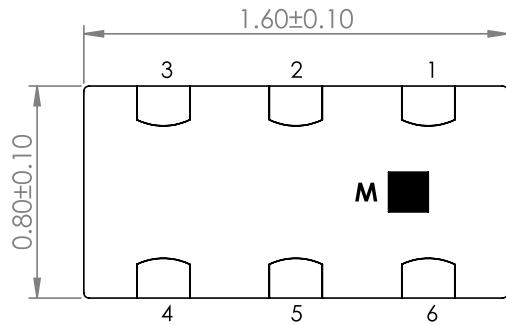

TOP VIEW

Pin #	Function
1	GND
2	Common Port
3	GND
4	High Band
5	GND
6	Low Band
M	Mark

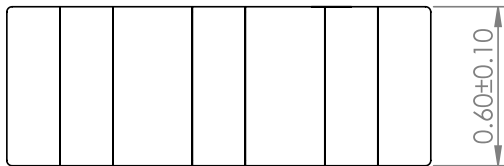

FRONT VIEW

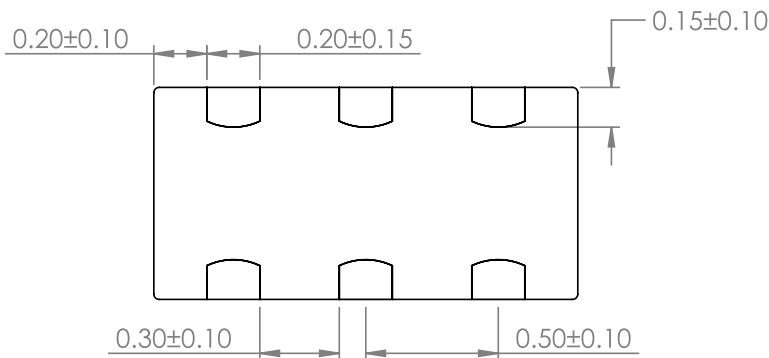

BOTTOM VIEW

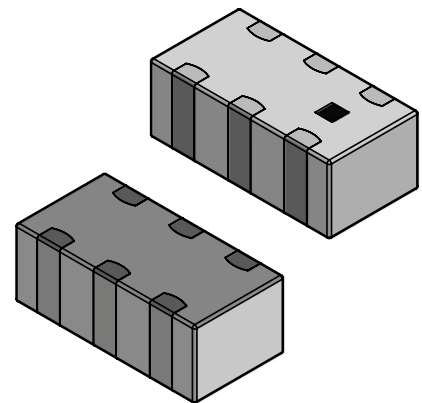

Unit: mm

Mini LTCC RF Diplexer for Bluetooth, Wi-Fi, UWB



ADID-R-0016

Request Samples

Check Inventory

1.6 x 0.8 x 0.6 mm
RoHS Compliant

Recommended Footprint (PCB Layout)

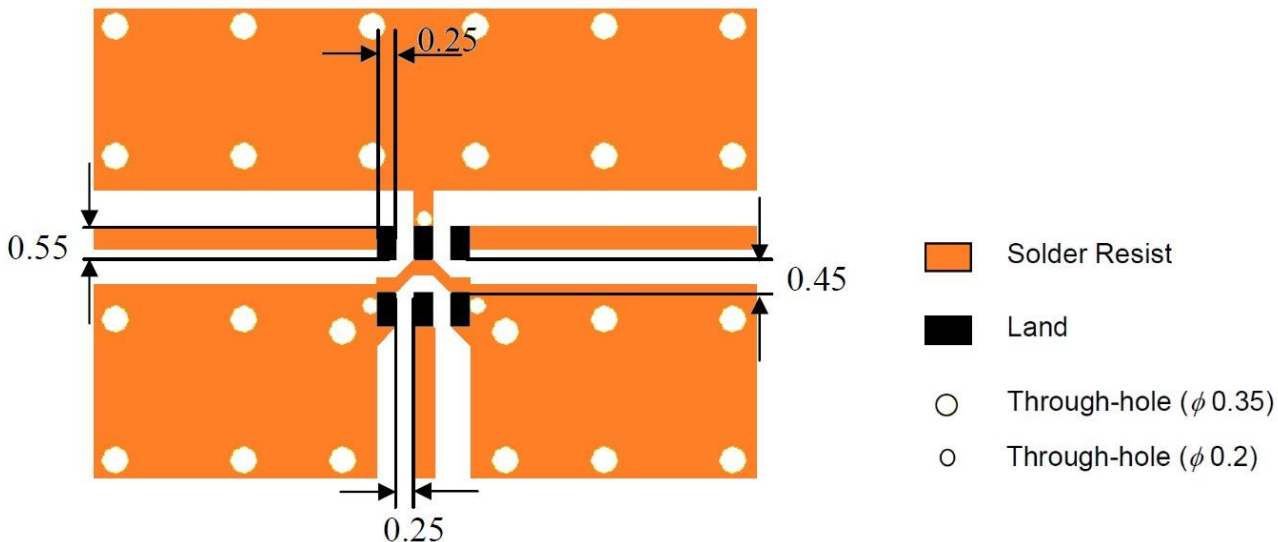

Unit: mm

Note: Line width to be designed to match 50 Ω characteristic impedance, depending on PCB material and thickness.

The transmission line is Gound Coplanar Waveguide (GCPW). For technical assistance, please contact [Abracon online support](#) through our online support platform.

Mini LTCC RF Diplexer for Bluetooth, Wi-Fi, UWB



ADID-R-0016

Request Samples



Check Inventory



1.6 x 0.8 x 0.6 mm
RoHS Compliant

Measurement Setup

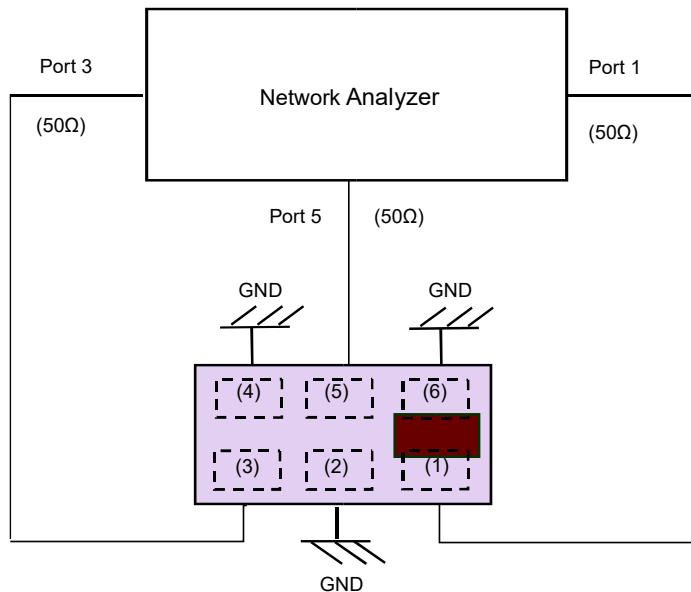

Pin #	Function
(1)	Lower Freq. Band
(2)	GND
(3)	Higher Freq. Band
(4)	GND
(5)	Common
(6)	GND

Mini LTCC RF Diplexer for Bluetooth, Wi-Fi, UWB



ADID-R-0016

Request Samples



Check Inventory



1.6 x 0.8 x 0.6 mm
RoHS Compliant

Frequency Characteristics

Insertion Loss (S21 & S31) 500 – 16500 MHz

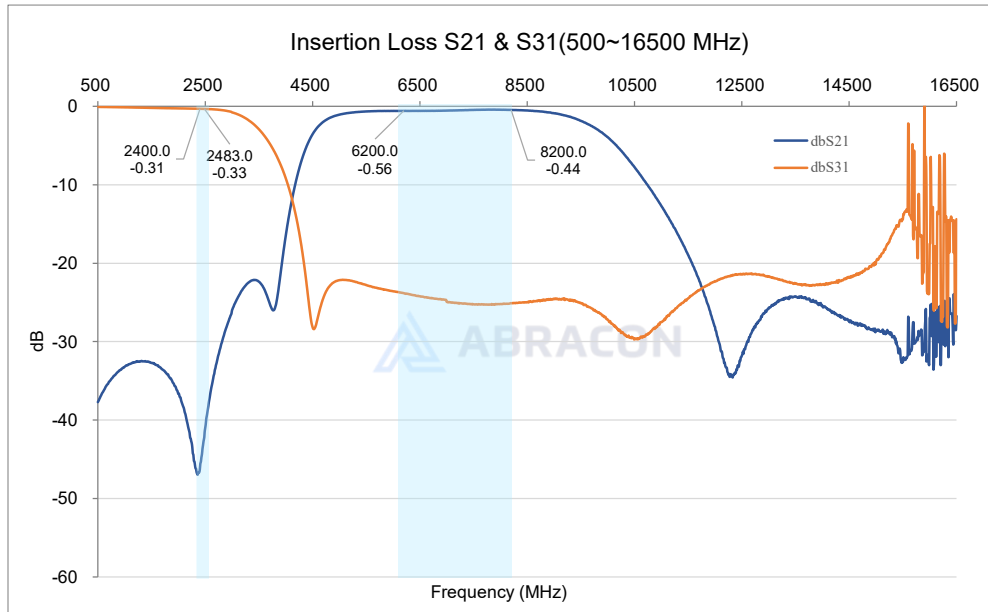

Return Loss (S11 & S22 & S33) 500 – 16500 MHz

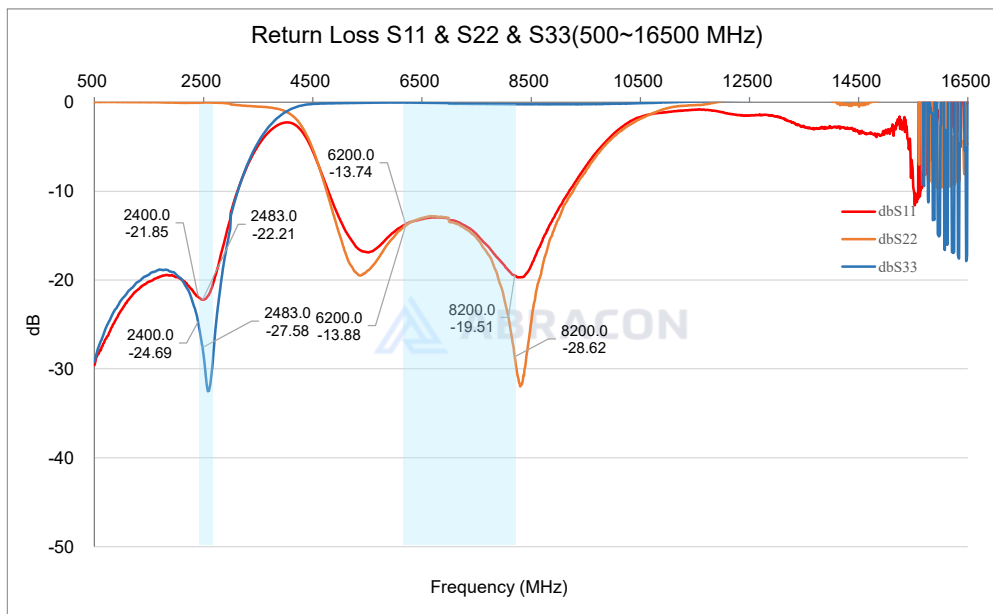

Mini LTCC RF Diplexer for Bluetooth, Wi-Fi, UWB



ADID-R-0016

Request Samples



Check Inventory



1.6 x 0.8 x 0.6 mm
RoHS Compliant

Isolation (S32) 500 – 16500 MHz

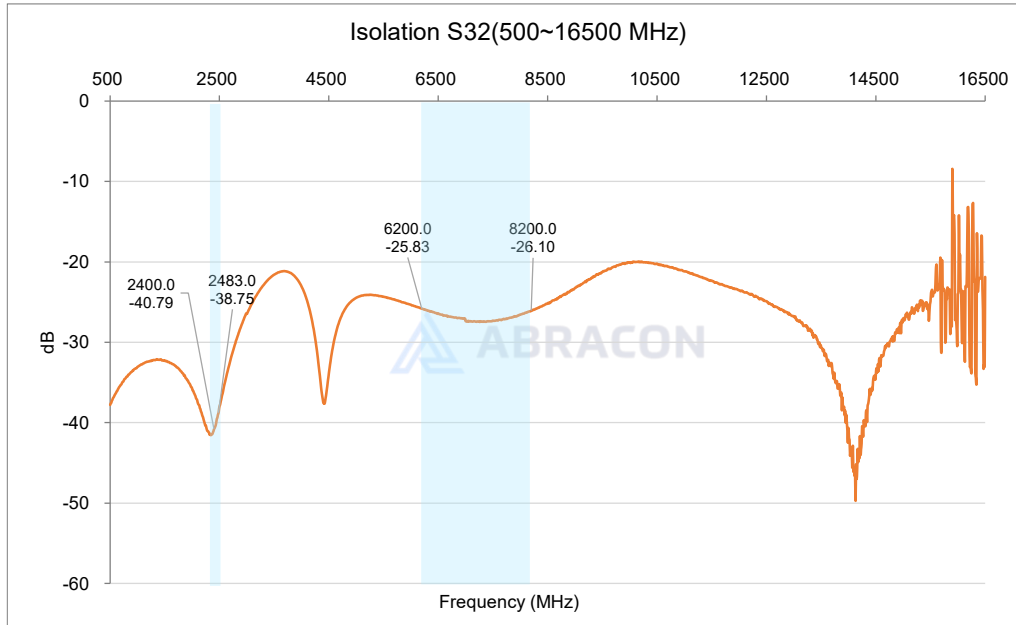

Mini LTCC RF Diplexer for Bluetooth, Wi-Fi, UWB



ADID-R-0016

Request Samples



Check Inventory



1.6 x 0.8 x 0.6 mm
RoHS Compliant

Reflow Profile [JEDEC J-STD-020]

Solder paste: Sn/3.0Ag/0.5Cu

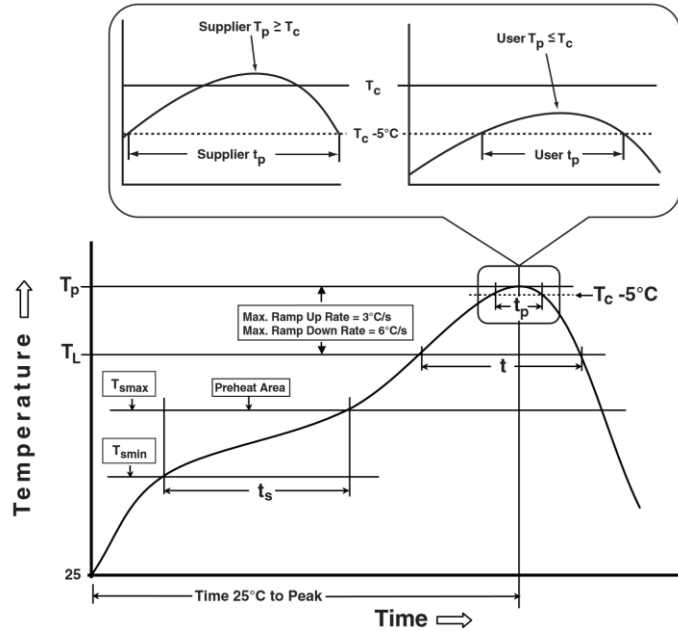

Table 1

SnPb Eutectic Process Classification Temperatures (T_c)		
Package Thickness	Volume mm^3 <350	Volume mm^3 ≥ 350
<2.5mm	235°C	220°C
$\geq 2.5\text{mm}$	220°C	220°C

Table 2

Pb-Free Process Classification Temperatures (T_c)			
Package Thickness	Volume mm^3 <350	Volume mm^3 350-2000	Volume mm^3 >2000
<1.6mm	260°C	260°C	260°C
1.6mm - 2.5mm	260°C	250°C	245°C
>2.5mm	250°C	245°C	245°C

Profile Feature	Sn-Pb Eutectic Assembly	Pb-Free Assembly
Preheat / soak		
Temperature minimum (T_{smin})	100°C	150°C
Temperature maximum (T_{smax})	150°C	200°C
Time (T_{smin} to T_{smax}) (t_s)	60 – 120 sec.	60 – 120 sec.
Average ramp-up rate (T_{smax} to T_p)	3°C/sec. max	3°C/sec. max
Liquidous temperature (T_L)	183°C	217°C
Time at Liquidous (T_L)	60 – 90 sec.	60 – 90 sec.
Peak package body temperature (T_p)*	See Table 1	See Table 2
Time (T_p)** within 5°C of the specified classification temperature (T_c)	20 sec.	10 sec.
Ramp-down rate (T_p to T_{smax})	6°C/sec. max	6°C/sec. max
Time 25°C to peak temperature	6 min. max	8 min. max
Reflow cycles	2 max	2 max

*Tolerance for peak profile temperature (T_p) is defined as a supplier minimum and a user maximum.

**Tolerance for time at peak profile temperature (t_p) is defined as a supplier minimum and a user maximum.

Mini LTCC RF Diplexer for Bluetooth, Wi-Fi, UWB



ADID-R-0016

Request Samples



Check Inventory



1.6 x 0.8 x 0.6 mm
RoHS Compliant

Packaging

Tape & Reel

1. Tape & Reel Dimension 1608(0603)

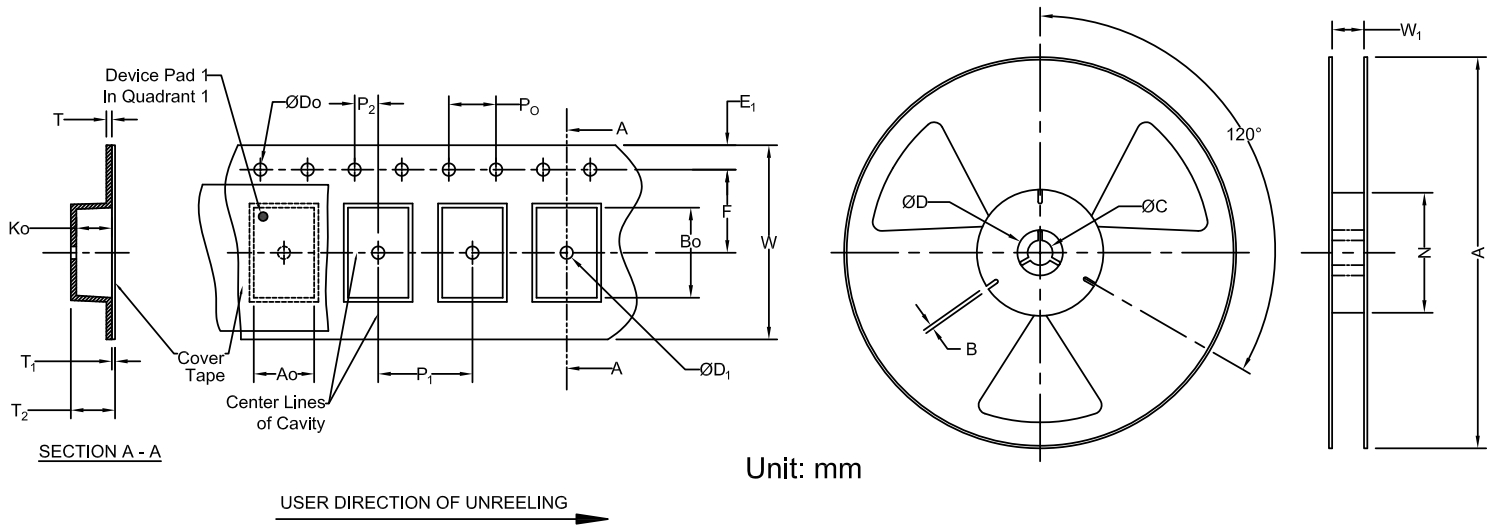

Carrier Tape Specifications (mm)

Do	E ₁	P ₀	P ₂	T	F	P ₁	W	A ₀	B ₀	Reel Qty
1.5±0.1	1.75±0.10	4.00±0.10	2.00±0.05	0.75±0.10	3.50±0.05	4.00±0.10	8.00±0.30	1.0±0.10	1.8±0.10	4,000

Reel Specifications (mm)

A	N	B	C
Φ178±2.0	Φ58.0±2.0	Φ2.45±0.20	Φ13.5±0.20

ATTENTION: Abracon LLC's products are Commercial-Off-The-Shelf (COTS), which are designed, intended, and validated for use in commercial, industrial, and automotive applications. The customer is responsible for testing and verifying the performance of an Abracon solution to meet their system-level requirements.



5101 Hidden Creek Ln Spicewood TX 78669
Phone: 512-371-6159 | Fax: 512-351-8858
For terms and conditions of sales, please visit:
www.abracon.com

REVISED: 01-15-25

ABRACON IS
ISO9001-2015
CERTIFIED