

Wi-Fi 6/6E/7 LTCC RF Diplexer

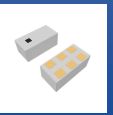

ADID-R-0012

Request Samples



Check Inventory



1.6 x 0.8 x 0.65 mm

RoHS Compliant

Features

- Supporting 2400~2500 / 5150~7150 MHz Simultaneously
- Small Form Factor 1.6 x 0.8 x 0.65 mm
- Low Insertion Loss 0.5 dB
- High Isolation Between Bands
- Temperature Stability Across Wide Temperature Bands
- High-Power Handling up to 3W
- RoHS Compliant

Applications

- Wi-Fi Modules
- AR/VR Headsets
- Wi-Fi Access Point and Mesh Wi-Fi Systems
- Smart Plugs, Lights, and Doorbells
- Smart TVs and Streaming Devices
- Laptops and PCs

Product Image

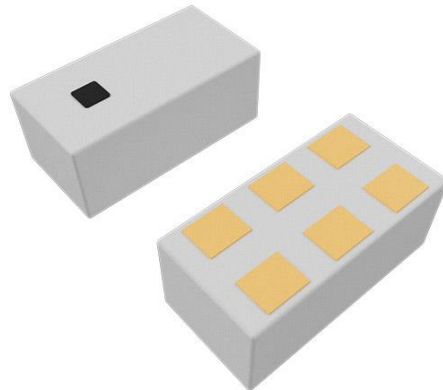

Wi-Fi 6/6E/7 LTCC RF Diplexer



ADID-R-0012

Request Samples



Check Inventory



1.6 x 0.8 x 0.65 mm

RoHS Compliant

Electrical Specifications

Parameters	Specification		Units	Notes
Passband	2400-2500	5150-7150	MHz	
Insertion Loss	0.5	1.0	dB	@25°C
	0.7	1.3		@-40°C ~ +85°C
VSWR	< 2.0		-	
Attenuation (min.)	40	-	dB	4800 ~ 5000 MHz
	30	-		7200 ~ 7500 MHz
	-	45		2400 ~ 2500 MHz
	-	29		10300 ~ 14300 MHz
	-	30		15300 ~ 21450 MHz
Isolation (min.)	40		dB	2400 ~ 2500 MHz
	40			4800 ~ 5000 MHz
	38			5000 ~ 6000 MHz
	30			6000 ~ 7150 MHz
Power Capacity	3		W	-

Mechanical Specifications

Parameters	Specifications
Filter Dimension	1.6 x 0.8 x 0.65 mm
Mounting Type	Surface Mount

Environmental Specifications

Parameters	Specifications
Operating Temperature	-40°C ~ +85°C
Storage Temperature	-10°C ~ +40°C (70% R.H. max)
Humidity	90% - 95% R.H.



5101 Hidden Creek Ln Spicewood TX 78669
 Phone: 512-371-6159 | Fax: 512-351-8858
 For terms and conditions of sales, please visit:
www.abracon.com

REVISED: 11-26-24

ABRACON IS
 ISO9001-2015
 CERTIFIED

Wi-Fi 6/6E/7 LTCC RF Diplexer



ADID-R-0012

Request Samples



Check Inventory



1.6 x 0.8 x 0.65 mm

RoHS Compliant

Ordering Information

Part Number	Description
ADID-R-0012	Wi-Fi 6/6E/7 LTCC RF Diplexer
ADID-R-0012-EVB	Wi-Fi 6/6E/7 LTCC RF Diplexer EVB

Note: Other options not listed may be available upon request via [Abracon online support](#)

Wi-Fi 6/6E/7 LTCC RF Diplexer

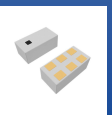

ADID-R-0012

Request Samples

Check Inventory

1.6 x 0.8 x 0.65 mm

RoHS Compliant

Package Dimensions & PCB Footprint

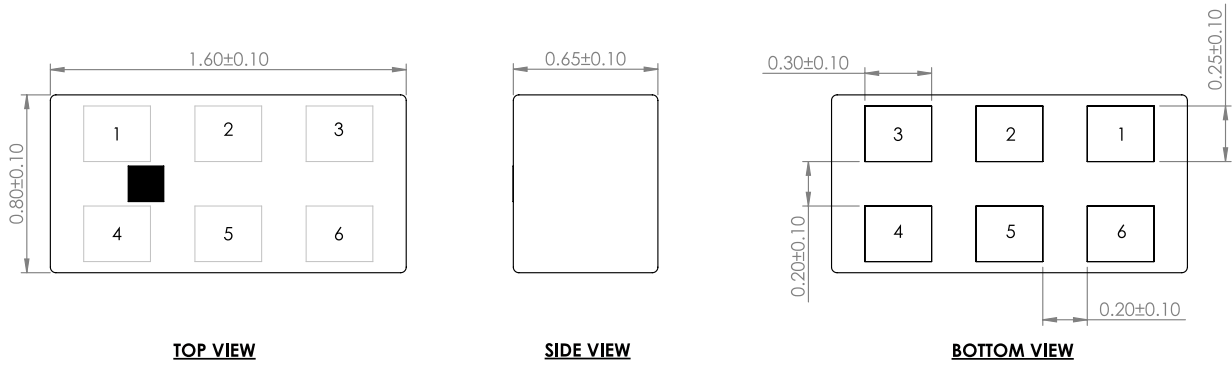

Pin #	Function
1	Low Freq. Port
2	GND
3	High Freq. Port
4	GND
5	Common Port
6	GND
M	MARK

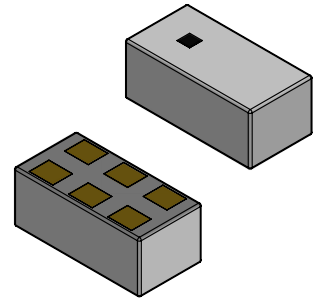

Unit: mm

Wi-Fi 6/6E/7 LTCC RF Diplexer

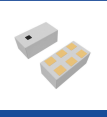

ADID-R-0012

Request Samples

Check Inventory

1.6 x 0.8 x 0.65 mm

RoHS Compliant

Recommended Footprint (PCB Layout)

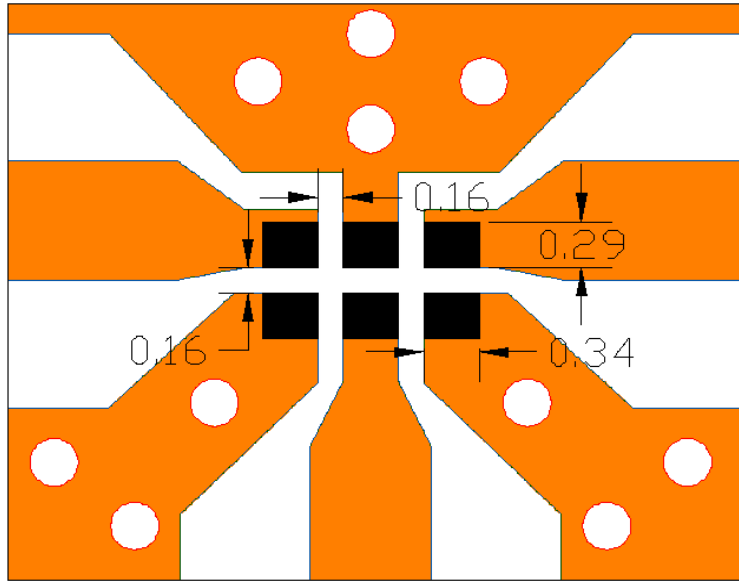

- Solder Resist
- Land
- Through hole: $\phi=0.2$

Unit: mm

Note: Line width to be designed to match 50Ω characteristic impedance, depending on PCB material and thickness. The transmission line is Gound Coplanar Waveguide (GCPW). For technical assistance, please contact [Abracon online support](#) through our online support platform.

Wi-Fi 6/6E/7 LTCC RF Diplexer

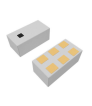

ADID-R-0012

Request Samples

Check Inventory

1.6 x 0.8 x 0.65 mm

RoHS Compliant

Measurement Setup

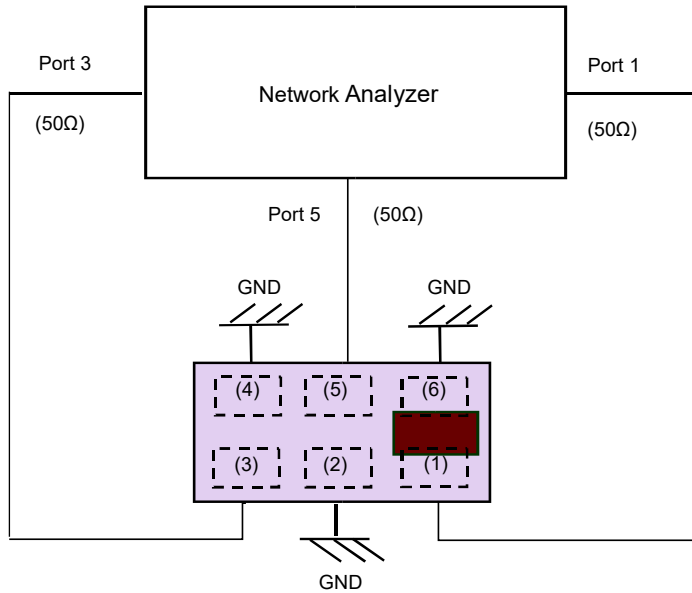

Pin #	Function
(1)	Lower Freq. Band
(2)	GND
(3)	Higher Freq. Band
(4)	GND
(5)	Common
(6)	GND

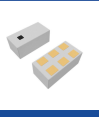

ADID-R-0012

Request Samples Check Inventory

1.6 x 0.8 x 0.65 mm
RoHS Compliant

Frequency Characteristics

Insertion Loss (S21 & S31) 500 – 17800 MHz

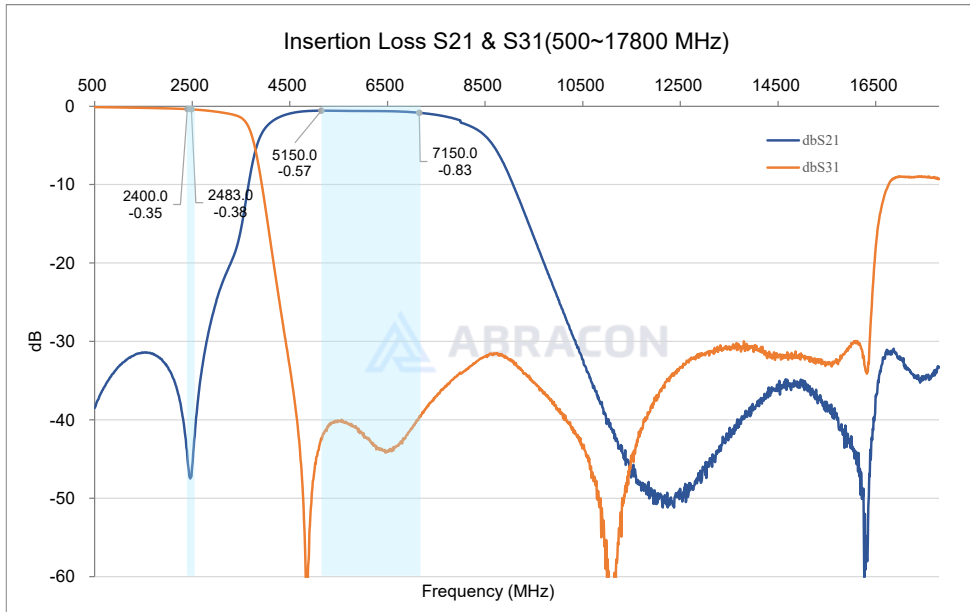

Return Loss (S11 & S22 & S33) 500 – 17800 MHz

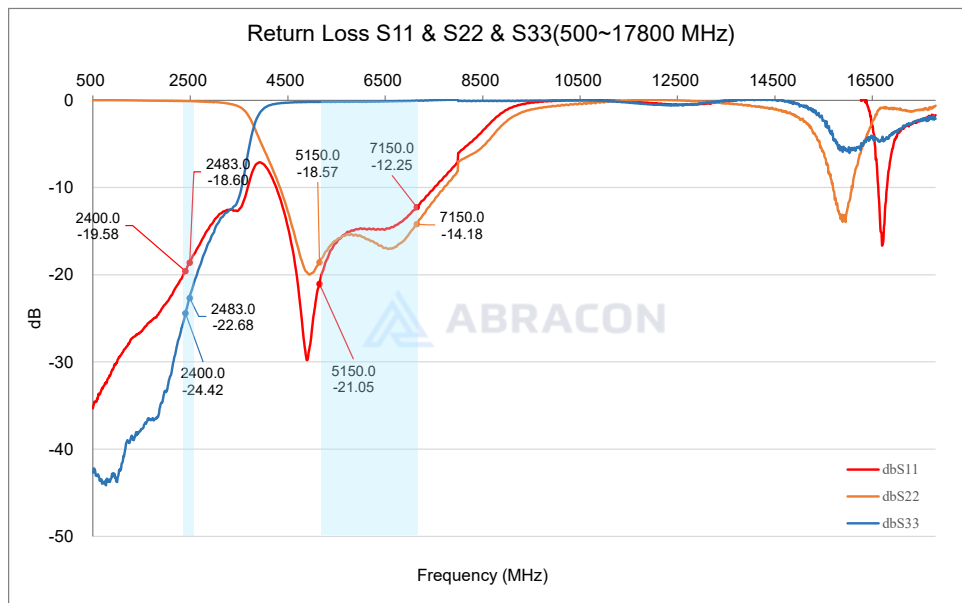

Wi-Fi 6/6E/7 LTCC RF Diplexer

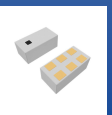

ADID-R-0012

Request Samples

Check Inventory

1.6 x 0.8 x 0.65 mm

RoHS Compliant

Isolation (S32) 500 – 17800 MHz

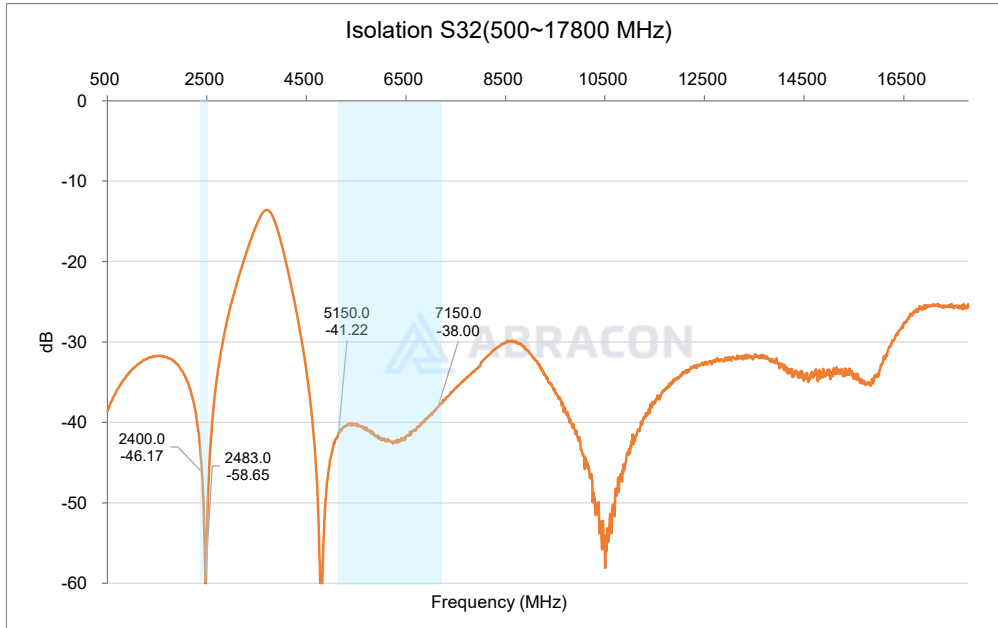

5101 Hidden Creek Ln Spicewood TX 78669
Phone: 512-371-6159 | Fax: 512-351-8858
For terms and conditions of sales, please visit:
www.abracon.com

REVISED: 11-26-24

ABRACON IS
ISO9001-2015
CERTIFIED

Wi-Fi 6/6E/7 LTCC RF Diplexer



ADID-R-0012

Request Samples



Check Inventory



1.6 x 0.8 x 0.65 mm

RoHS Compliant

Reflow Profile [JEDEC J-STD-020]

Solder paste: Sn/3.0Ag/0.5Cu

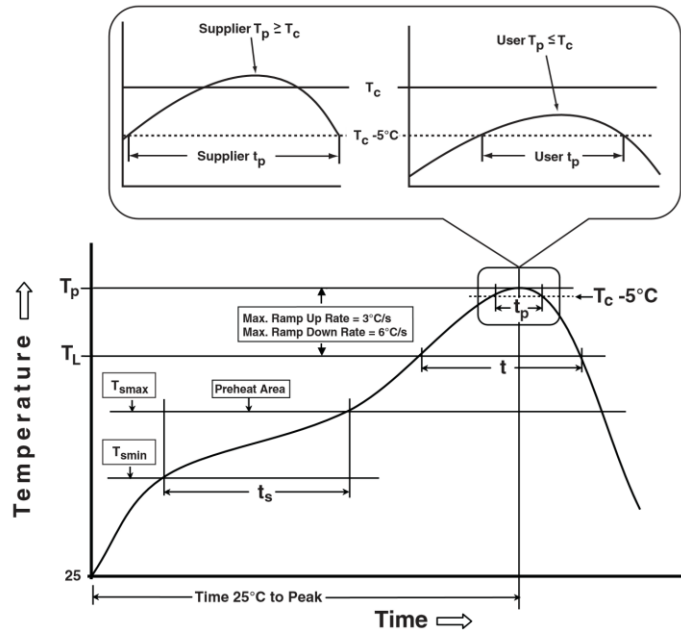

Table 1

SnPb Eutectic Process Classification Temperatures (T_c)		
Package Thickness	Volume mm^3 <350	Volume mm^3 ≥ 350
<2.5mm	235°C	220°C
$\geq 2.5\text{mm}$	220°C	220°C

Table 2

Pb-Free Process Classification Temperatures (T_c)			
Package Thickness	Volume mm^3 <350	Volume mm^3 350-2000	Volume mm^3 >2000
<1.6mm	260°C	260°C	260°C
1.6mm - 2.5mm	260°C	250°C	245°C
>2.5mm	250°C	245°C	245°C

Profile Feature	Sn-Pb Eutectic Assembly	Pb-Free Assembly
Preheat / soak		
Temperature minimum (T_{smin})	100°C	150°C
Temperature maximum (T_{smax})	150°C	200°C
Time (T_{smin} to T_{smax}) (t_s)	60 – 120 sec.	60 – 90 sec.
Average ramp-up rate (T_{smax} to T_p)	3°C/sec. max	3°C/sec. max
Liquidous temperature (T_L)	183°C	217°C
Time at Liquidous (T_L)	60 – 150 sec.	60 – 150 sec.
Peak package body temperature (T_p)*	See Table 1	See Table 2
Time (T_p)** within 5°C of the specified classification temperature (T_c)	20 sec.	10 sec.
Ramp-down rate (T_p to T_{smax})	6°C/sec. max	6°C/sec. max
Time 25°C to peak temperature	6 min. max	8 min. max
Reflow cycles	2 max	2 max

*Tolerance for peak profile temperature (T_p) is defined as a supplier minimum and a user maximum.

**Tolerance for time at peak profile temperature (t_p) is defined as a supplier minimum and a user maximum.



5101 Hidden Creek Ln Spicewood TX 78669
 Phone: 512-371-6159 | Fax: 512-351-8858
 For terms and conditions of sales, please visit:
www.abracon.com

REVISED: 11-26-24

ABRACON IS
 ISO9001-2015
 CERTIFIED

Wi-Fi 6/6E/7 LTCC RF Diplexer

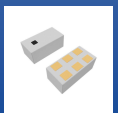

ADID-R-0012

Request Samples

Check Inventory

1.6 x 0.8 x 0.65 mm

RoHS Compliant

Packaging

Tape & Reel

1. Tape & Reel Dimension 1608(0603)

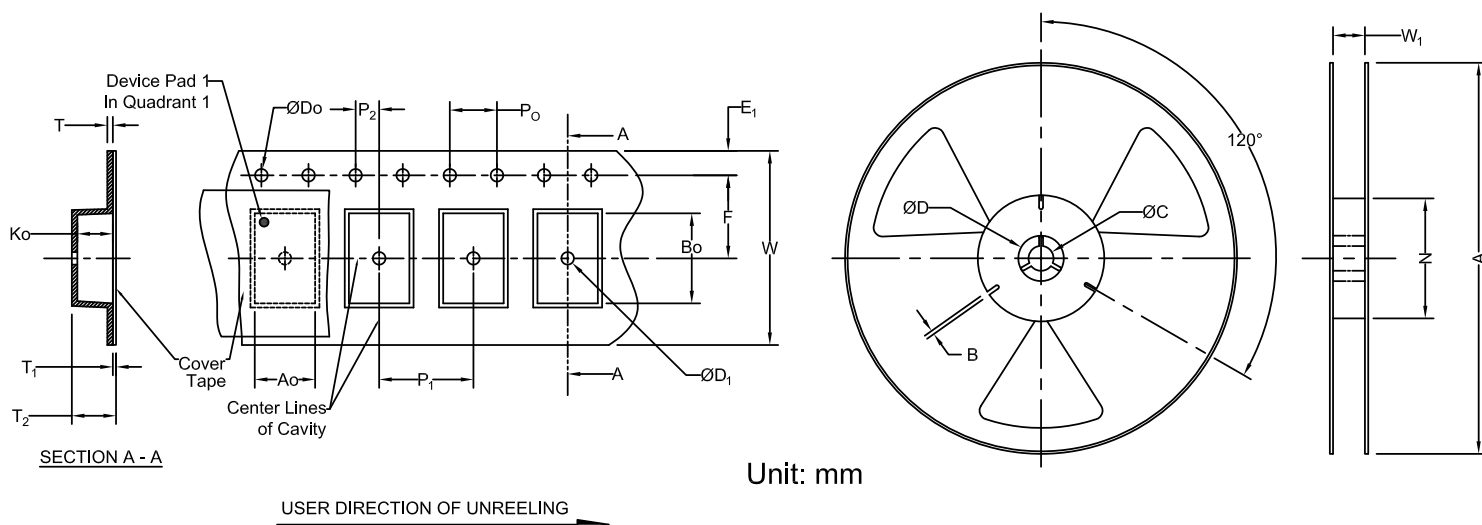

Carrier Tape Specifications (mm)

Do	E ₁	P ₀	P ₂	T	F	P ₁	W	A ₀	B ₀	Reel Qty
1.5±0.1	1.75±0.10	4.00±0.10	2.00±0.05	0.75±0.10	3.50±0.05	4.00±0.10	8.00±0.30	1.0±0.10	1.8±0.10	4,000

Reel Specifications (mm)

A	N	B	C
Φ178±2.0	Φ58.0±2.0	Φ2.45±0.20	Φ13.5±0.20

ATTENTION: Abracon LLC's products are Commercial-Off-The-Shelf ('COTS'), which are designed, intended, and validated for use in commercial, industrial, and automotive applications. The customer is responsible for testing and verifying the performance of an Abracon solution to meet their system-level requirements.



5101 Hidden Creek Ln Spicewood TX 78669
 Phone: 512-371-6159 | Fax: 512-351-8858
 For terms and conditions of sales, please visit:
www.abracon.com

REVISED: 11-26-24

ABRACON IS
 ISO9001-2015
 CERTIFIED