



Automotive Signal Common Mode Chokes

ACMS-4523E

Request Samples



Check Inventory



4.5 x 3.2 x 2.3 mm
RoHS/RoHS II Compliant
MSL Level = 1

Features

- AEC-Q200 compliant, Grade 1
- PPAP ready and supported
- Manufactured in TS/IATF 16949 production lines
- Excellent impedance characteristics

Applications

- Differential signal line common mode noise suppression.
- Multimedia devices
- Automotive applications such as ADAS, Infotainment, Sensing, TCU
- Automotive Ethernet

Electrical Specifications

Part Number	Inductance (μ H) (+50%/-25%)	DCR ($m\Omega$)	Rated Current (A)	Rated Voltage (Vdc)	Insulation Resistance ($M\Omega$)
		Max	Max	Max	Min
ACMS-Q4523E-201	200	4500	0.11	50	10

Rated Current is based on an Irms temperature rise of 20°C

Inductance Test Conditions: 0.1MHz/0.1V

ACMS-Q4523E is AEC-Q200 Automotive certified

Operating Temperature: -40°C to +125°C (Including self-heating)

Storage Temperature (on PCB): -40°C to +125°C

Storage (in original packaging): <40°C, <70% RH



5101 Hidden Creek Ln, Spicewood TX 78669
Phone: 512-371-6159 Fax: 512-351-8858
For terms and conditions of sales, please visit:
www.abracon.com

REVISION Initial Release
Revised: 3/30/2022

ABRACON IS
ISO9001-2015
CERTIFIED



Automotive Signal Common Mode Chokes

ACMS-4523E

Request Samples



Check Inventory



4.5 x 3.2 x 2.3 mm
RoHS/RoHS II Compliant
MSL Level = 1

Electrical Specifications

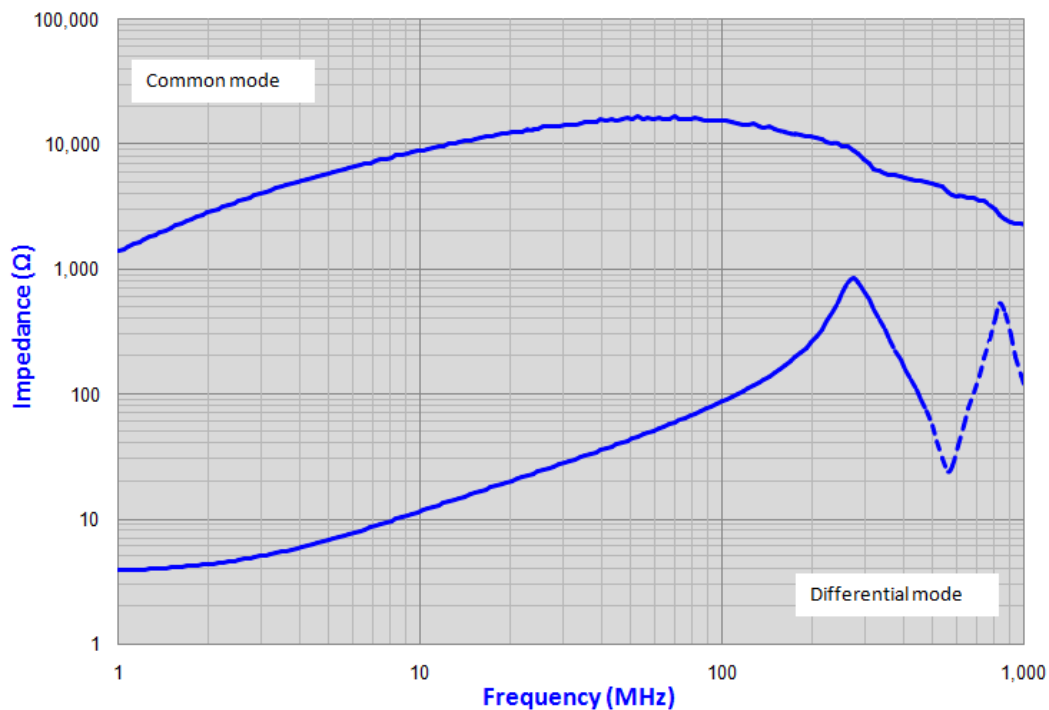



Automotive Signal Common Mode Chokes

ACMS-4523E

Request Samples

Check Inventory

4.5 x 3.2 x 2.3 mm
RoHS/RoHS II Compliant
 MSL Level = 1

Mechanical Specifications

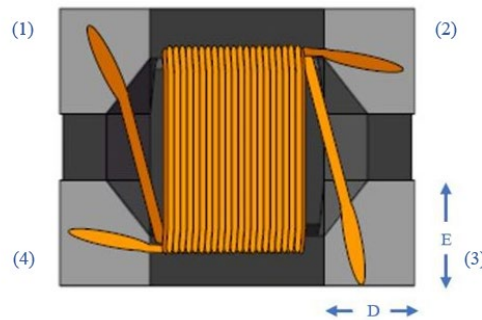
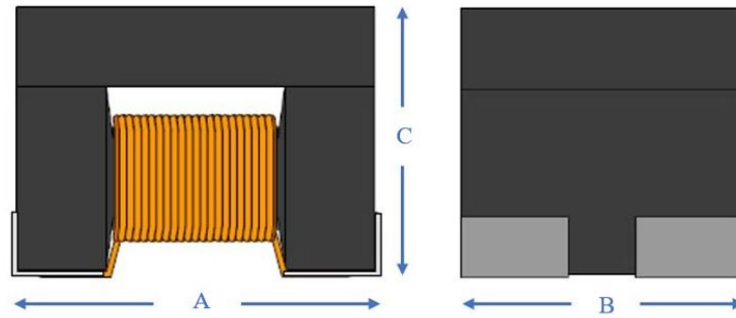

A	B	C	D	E
4.5 ±0.2	3.2 ±0.2	2.3 ±0.2	1.0 ±0.1	1.25 ±0.1

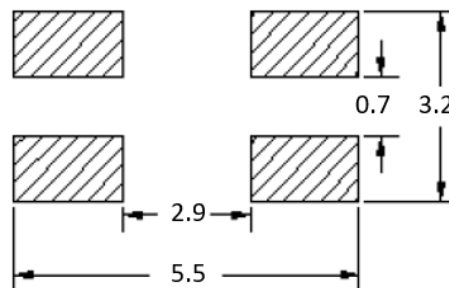

Recommended Layout

Dimensions: mm



5101 Hidden Creek Ln, Spicewood TX 78669
 Phone: 512-371-6159 Fax: 512-351-8858
 For terms and conditions of sales, please visit:
www.abracon.com

REVISION Initial Release
 Revised: 3/30/2022

ABRACON IS
 ISO9001-2015
 CERTIFIED



Automotive Signal Common Mode Chokes

ACMS-4523E

Request Samples



Check Inventory



4.5 x 3.2 x 2.3 mm
RoHS/RoHS II Compliant
 MSL Level = 1

Schematic

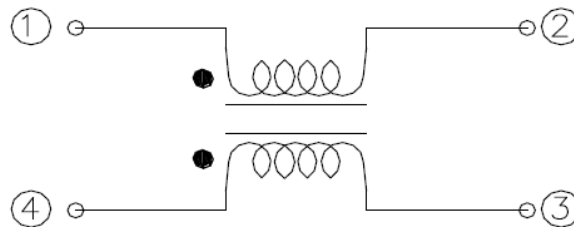

Materials

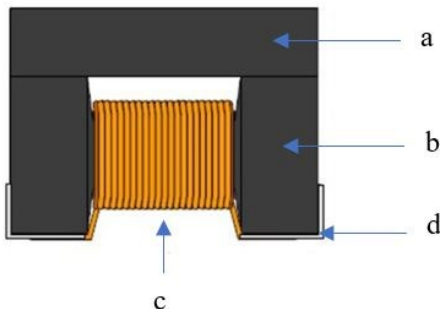

	Description	Specification
a	Upper Plate	Ni-Zn Ferrite
b	Core	Ni-Zn Ferrite
c	Wire	Enameled copper wire
d	Electrode	Ag/Ni/Sn

Part Identification

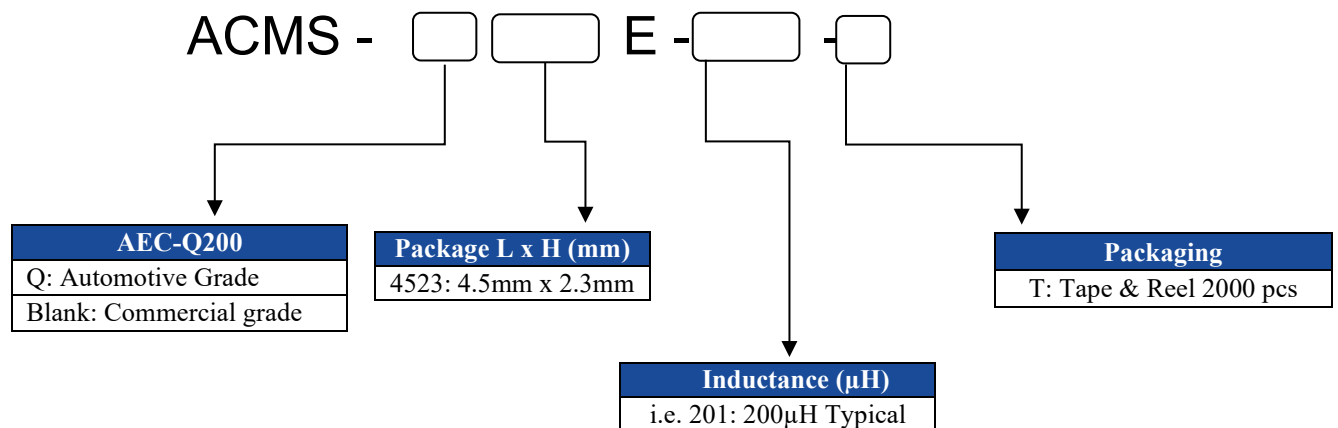



Automotive Signal Common Mode Chokes

ACMS-4523E

Request Samples



Check Inventory



4.5 x 3.2 x 2.3 mm
 RoHS/RoHS II Compliant
 MSL Level = 1

Reflow Profile

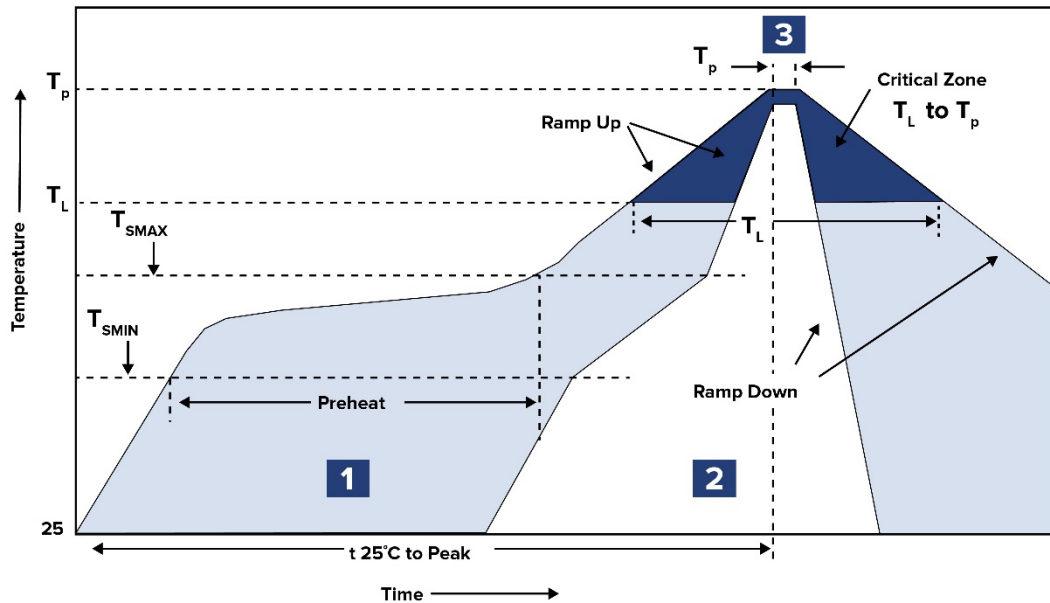

Zone	Description	Temperature	Times
1	Preheat	$T_{SMIN} \sim T_{SMAX}$ 150°C ~ 200°C	60 ~ 120 sec.
2	Reflow	T_L 220°C	60 ~ 90 sec.
3	Peak heat	T_P 260°C Max	10 sec. MAX



Automotive Signal Common Mode Chokes

ACMS-4523E

Request Samples



Check Inventory



4.5 x 3.2 x 2.3 mm
RoHS/RoHS II Compliant
 MSL Level = 1

Packaging

Tape & Reel: 2000pcs/reel

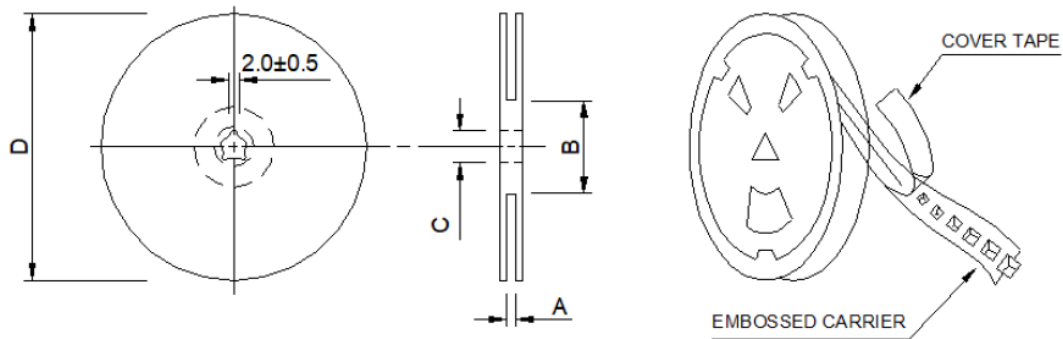

Series	A	B	C	D
ACMS-Q4523E	13.0 ±0.5	100.0 ±2.0	13.0 ±0.5	330

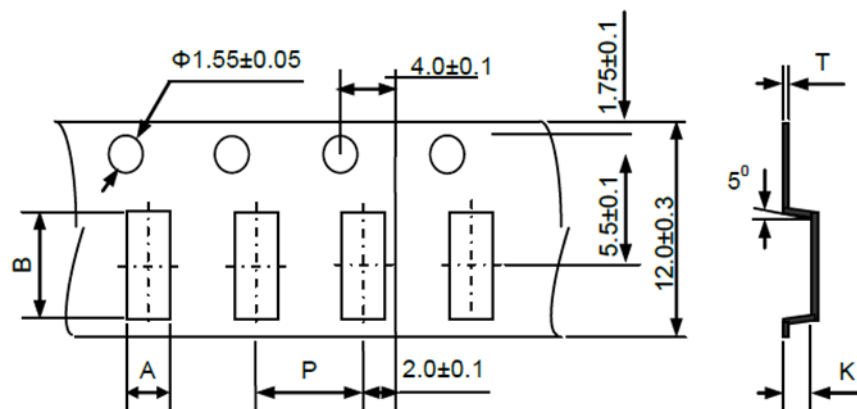

A	B	P	K	T
3.51 ±0.10	4.82 ±0.10	8.0 ±0.10	3.05 ±0.10	0.35 ±0.05

Dimensions: mm

ATTENTION: Abracon LLC's products are COTS – Commercial-Off-The-Shelf products; suitable for Commercial, Industrial and, where designated, Automotive Applications. Abracon's products are not specifically designed for Military, Aviation, Aerospace, Life-dependent Medical applications or any application requiring high reliability where component failure could result in loss of life and/or property. For applications requiring high reliability and/or presenting an extreme operating environment, written consent and authorization from Abracon LLC is required. Please contact Abracon LLC for more information.



5101 Hidden Creek Ln, Spicewood TX 78669
 Phone: 512-371-6159 Fax: 512-351-8858
 For terms and conditions of sales, please visit:
www.abracon.com

REVISION Initial Release
 Revised: 3/30/2022

ABRACON IS
 ISO9001-2015
 CERTIFIED