

# Power Common Mode Chokes

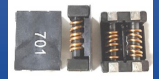

## ACMP-1566 Series

Request Samples



Check Inventory



15.0 x 13.0 x 6.6 mm  
RoHS/RoHS II Compliant  
MSL Level = 1

### Features

- Commercial Grade
- PPAP ready and supported
- Excellent impedance characteristics
- Rated current up to 13A
- Extremely Low DCR

### Applications

- DC power line common mode noise suppression.
- Switch Mode Power Supplies and regulators
- Variable Frequency Drives
- AC/DC power rectifiers

### Electrical Specifications

Part Number	Impedance ( $\Omega$ ) @100MHz		DCR (m $\Omega$ )	Rated Current (A)	Rated Voltage (Vdc)	Insulation Resistance (M $\Omega$ )
	Min	Typ.	Max	Typ.	Max	Min
ACMP-1566-301	225	300	5.0	13	80	10
ACMP-1566-501	400	500	6.0	10	80	10
ACMP-1566-551	400	550	6.0	10	80	10
ACMP-1566-601	500	600	7.0	10	80	10
ACMP-1566-701	500	700	7.0	10	80	10
ACMP-1566-102	800	1000	10	9	80	10
ACMP-1566-152	1200	1500	23	5	80	10

**Rated Current is based on an Irms temperature rise of 40°C**

**Operating Temperature: -40°C to +125°C (Including self-heating)**

**Storage (in original packaging): <40°C, <70% RH**

**ACMP-1566 Series is RoHS Compliant and Pb free**

# Power Common Mode Chokes



ACMP-1566 Series

Request Samples



Check Inventory



15.0 x 13.0 x 6.6 mm  
RoHS/RoHS II Compliant  
MSL Level = 1

## Electrical Specifications (Cont'd)

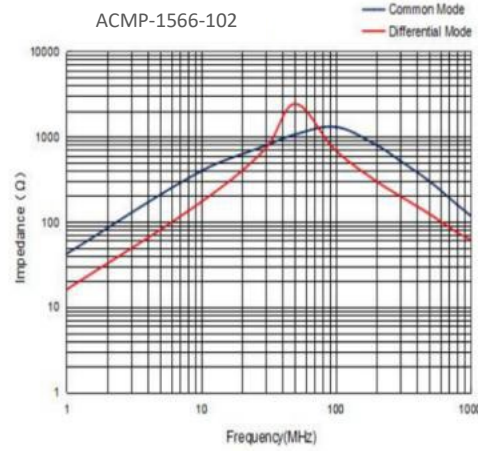
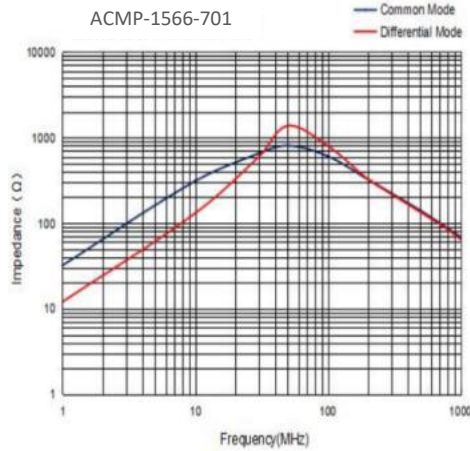
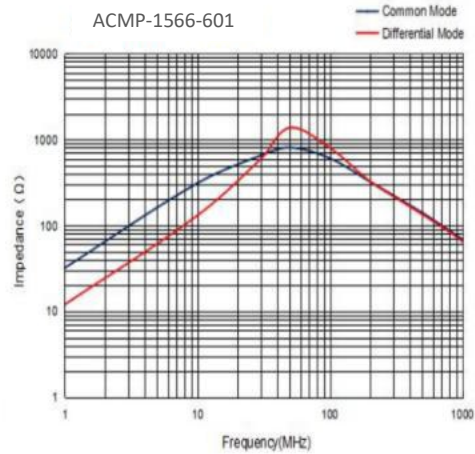
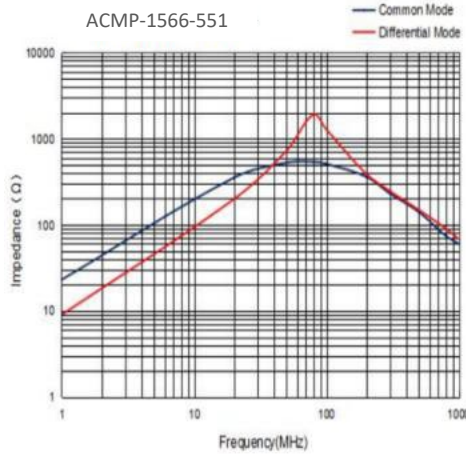
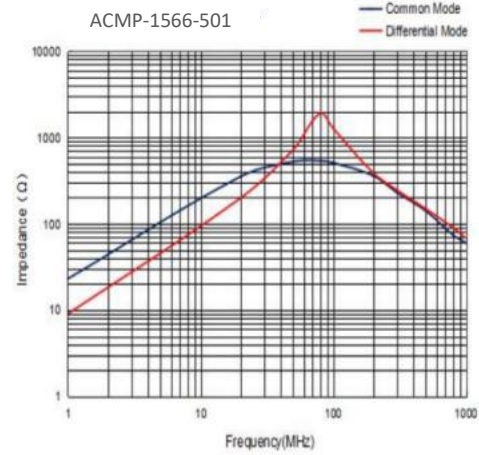
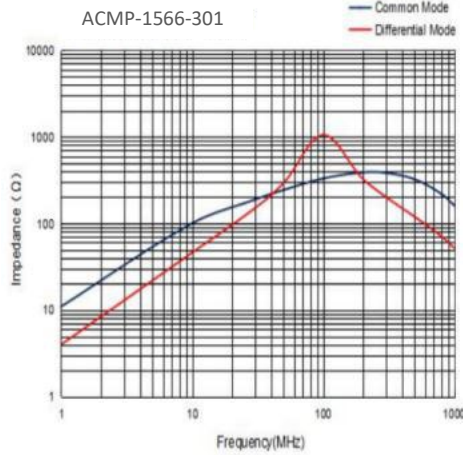

5101 Hidden Creek Ln Spicewood TX 78669  
Phone: 512-371-6159 | Fax: 512-351-8858  
For terms and conditions of sales, please visit:  
[www.abracon.com](http://www.abracon.com)

REVISION: IR 06-29-22

ABRACON IS  
ISO9001-2015  
CERTIFIED

# Power Common Mode Chokes



**ACMP-1566 Series**

Request Samples



Check Inventory



**15.0 x 13.0 x 6.6 mm**  
**RoHS/RoHS II Compliant**  
**MSL Level = 1**

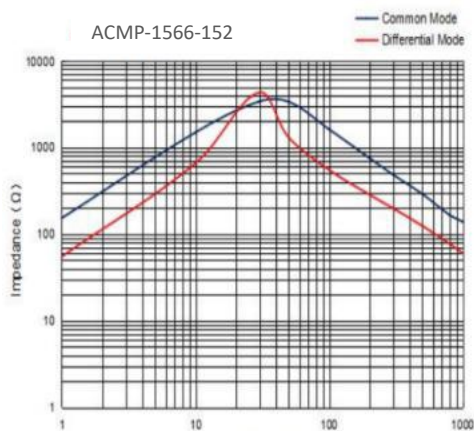

## Mechanical Specifications

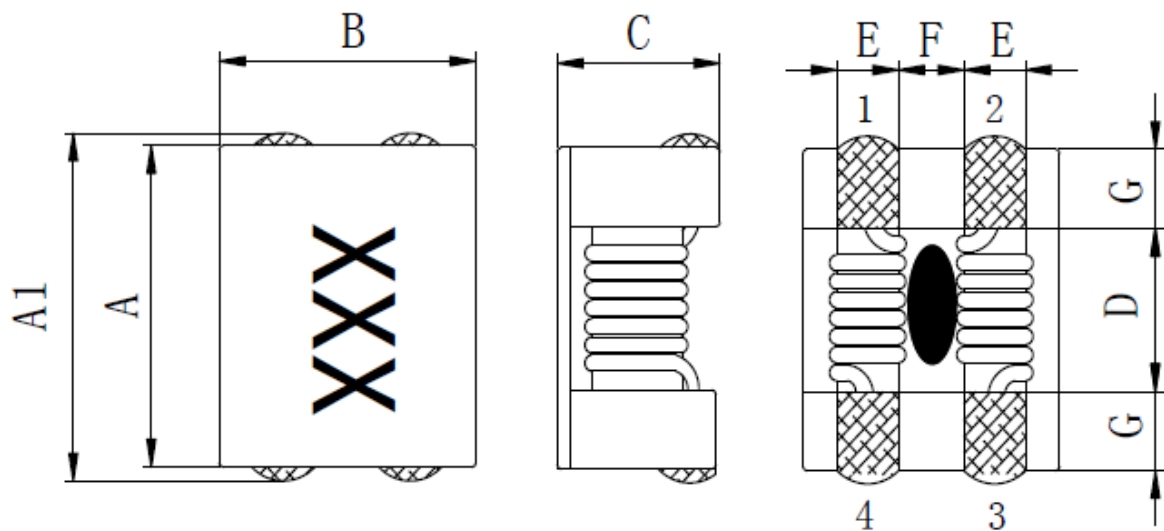

A	A1	B	C	D	E	G
15.0 ± 0.5	15.6 ± 0.5	13 ± 0.5	6.6 MAX	9.4 Ref.	2.6 Ref	2.5 Ref.

Dimensions: mm



5101 Hidden Creek Ln Spicewood TX 78669  
 Phone: 512-371-6159 | Fax: 512-351-8858  
 For terms and conditions of sales, please visit:  
[www.abracon.com](http://www.abracon.com)

REVISION: IR 06-29-22

ABRACON IS  
 ISO9001-2015  
 CERTIFIED

# Power Common Mode Chokes

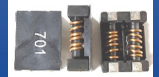

**ACMP-1566 Series**

Request Samples



Check Inventory



15.0 x 13.0 x 6.6 mm  
**RoHS/RoHS II Compliant**  
 MSL Level = 1

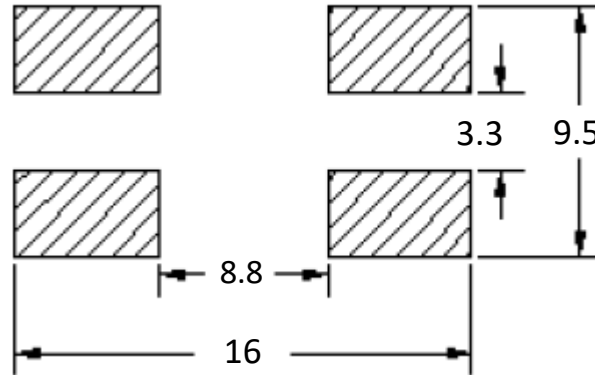

## Recommended Layout

Dimensions: mm

## Schematic

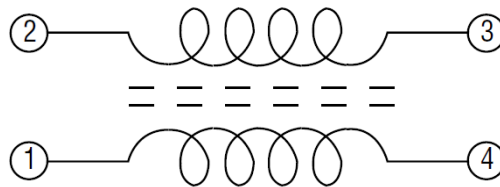

## Materials

Description	Specification
Core	Ferrite core
Wire	Enameled copper wire
Base	LCP
Adhesive	Epoxy resin
Terminal	Sn/Cu
Ink	White

# Power Common Mode Chokes



**ACMP-1566 Series**

Request Samples



Check Inventory



15.0 x 13.0 x 6.6 mm  
**RoHS/RoHS II Compliant**  
 MSL Level = 1

## Part Identification

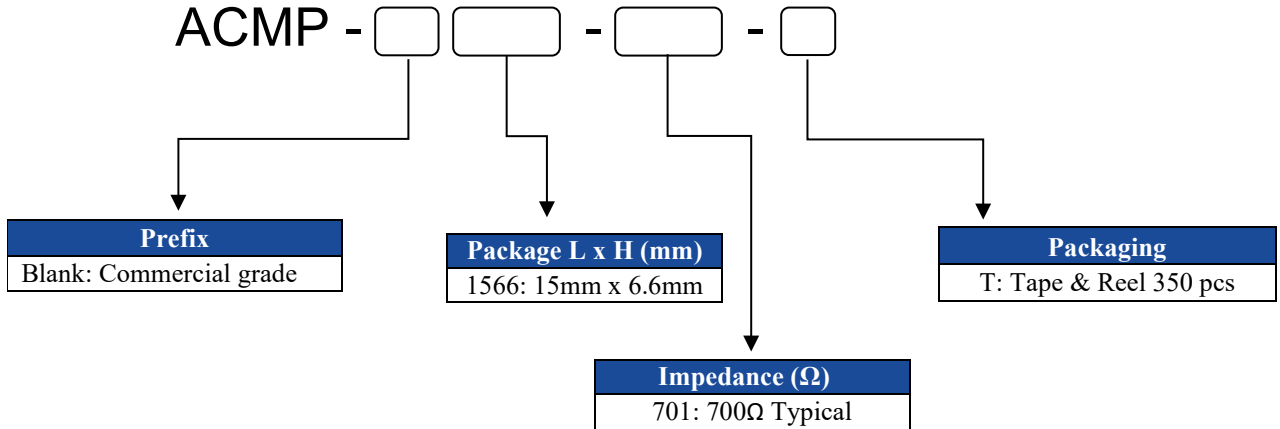

## Reflow Profile

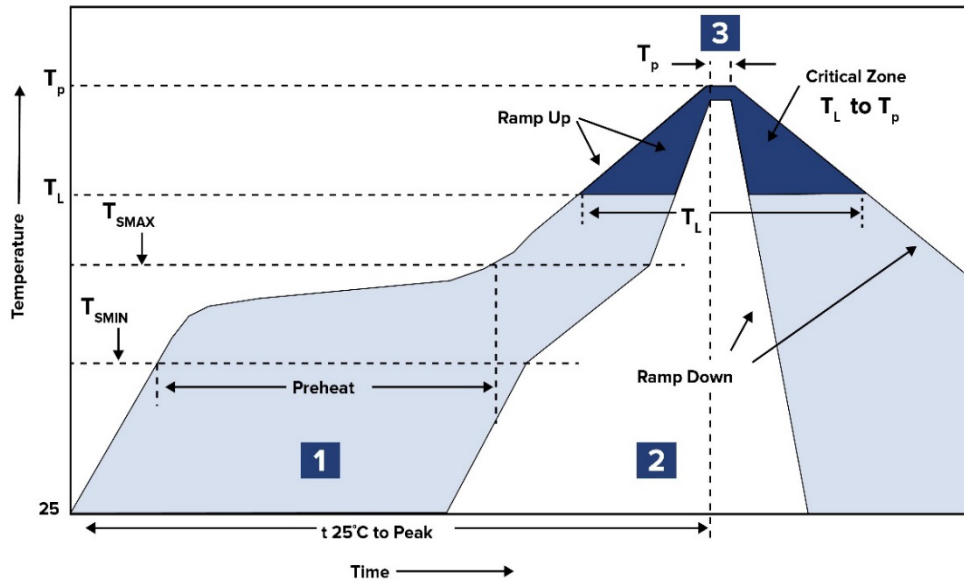

Zone	Description	Temperature	Times
1	Preheat	$T_{SMIN} \sim T_{SMAX}$ 150°C ~ 190°C	60 ~ 120 sec.
2	Reflow	$T_L$ 240°C	20 ~ 40 sec.
3	Peak heat	$T_P$ 260°C Max.	5 sec. Max

1~2 °C/Sec. Ramp



5101 Hidden Creek Ln Spicewood TX 78669  
 Phone: 512-371-6159 | Fax: 512-351-8858  
 For terms and conditions of sales, please visit:  
[www.abracon.com](http://www.abracon.com)

REVISION: IR 06-29-22

ABRACON IS  
 ISO9001-2015  
 CERTIFIED

# Power Common Mode Chokes

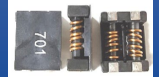

**ACMP-1566 Series**

Request Samples



Check Inventory



**15.0 x 13.0 x 6.6 mm**  
**RoHS/RoHS II Compliant**  
**MSL Level = 1**

## Packing

**Tape & Reel: 350pcs/reel**

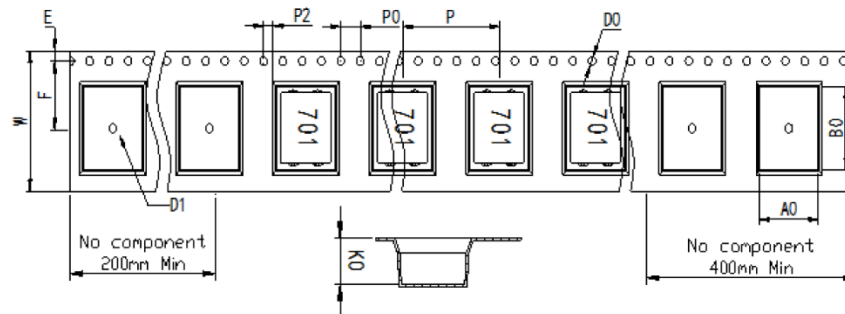
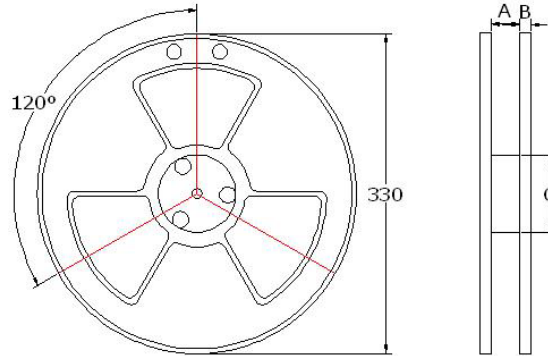

W	P	P0	P2	D0	E	F	A0	B0	K0
24 ± 0.30	20 ± 0.10	4.0 ± 0.10	2.0 ± 0.10	1.5 ± 0.10	1.75 ± 0.10	11.5 ± 0.10	14 ± 0.10	16.1 ± 0.10	6.6 ± 0.10

**Dimensions: mm**

**ATTENTION:** Abracon LLC's products are COTS – Commercial-Off-The-Shelf products; suitable for Commercial, Industrial and, where designated, Automotive Applications. Abracon's products are not specifically designed for Military, Aviation, Aerospace, Life-dependent Medical applications or any application requiring high reliability where component failure could result in loss of life and/or property. For applications requiring high reliability and/or presenting an extreme operating environment, written consent and authorization from Abracon LLC is required. Please contact Abracon LLC for more information.



5101 Hidden Creek Ln Spicewood TX 78669  
 Phone: 512-371-6159 | Fax: 512-351-8858  
 For terms and conditions of sales, please visit:  
[www.abracon.com](http://www.abracon.com)

**REVISION: IR 06-29-22**

ABRACON IS  
 ISO9001-2015  
 CERTIFIED