

Automotive-Grade UWB 6.24-8.24GHz Chip Antenna



AANI-CH-0136-Q

Request Samples



Check Inventory



3.2 x 1.6 x 1.1 mm
RoHS/RoHS II Compliant
MSL Level = 1

Features

- Automotive Qualification (AEC-Q200)
- PPAP Ready and Supported
- TS16949 Certified Production Lines
- Miniaturized in Size: 3.2 x 1.6 x 1.1 mm
- Low Return Loss of: ≤ -15.1 dB
- Peak Gain: 3.9 dBi
- Average Total Efficiency: -1.3 dB (74%)
- Linear Polarization
- Surface Mount (SMD)
- Integration: PCB Corner Mount

Applications

- UWB Channels: 5,6,8,9 (6.24-8.24 GHz)
- Digital Car Keys
- Secure Access Control
- Driver Authentication
- In-Cabin Occupant Detection
- Vehicle-to-Vehicle Ranging
- Parking Assistance
- Theft Prevention
- Car-Sharing Systems

Product Image

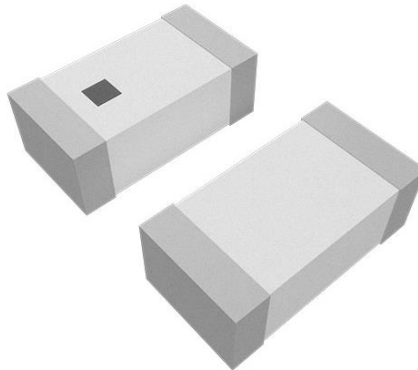

5101 Hidden Creek Ln Spicewood TX 78669
Phone: 512-371-6159 | Fax: 512-351-8858
For terms and conditions of sales, please visit:
www.abracon.com

REVISION I.R: 01-31-25

ABRACON IS
ISO9001-2015
CERTIFIED

Automotive-Grade UWB 6.24-8.24GHz Chip Antenna

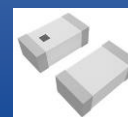

AANI-CH-0136-Q

Request Samples



Check Inventory



3.2 x 1.6 x 1.1 mm
RoHS/RoHS II Compliant
MSL Level = 1

Electrical Specification

Parameter	Specification				Unit
UWB Channel	5	6	8	9	-
Operating Frequency	6240 - 6739	6739 - 7238	7238 - 7738	7738 - 8237	MHz
Return Loss	< -15.1	< -17.2	< -15.9	< -15.6	dB
VSWR	< 1.4	< 1.3	< 1.4	< 1.4	:1
Polarization	Linear				-
Peak Gain	3.2	3.9	3.9	3.2	dBi
Minimum Total Efficiency	-1.7 (68)	-1.4 (72)	-1.5 (70)	-2.1 (62)	dB (%)
Average Total Efficiency	-1.4 (73)	-1.0 (80)	-1.1 (77)	-1.8 (65)	dB (%)
Maximum Total Efficiency	-1.0 (79)	-0.6 (87)	-1.0 (80)	-1.5 (71)	dB (%)
Impedance	50				Ω
Radiation Pattern	Omni-directional				-
Input Power	< 3				W

Note: All measurements were performed using the evaluation board in a free-space environment. Actual performance may vary depending on factors such as the ground plane, specific application, and surrounding environment.

Mechanical Specification

Parameter	Specification
Antenna Dimension	3.2 x 1.6 x 1.1 mm
Evaluation board Dimension	35 x 30 mm
Recommended Ground Clearance for Antenna	10 x 6 mm
Mounting Type	Surface Mount
Mounting Location	PCB Corner Mount
Material(s)	Ceramic

Environmental Specification

Parameter	Specification
Operating and Storage Temperature (individual chip without packing)	-40°C ~ +125°C
Packaging Storage Temperature	-10°C ~ +40°C
Packaging Storage Relative Humidity	70% (Max.)



5101 Hidden Creek Ln Spicewood TX 78669
 Phone: 512-371-6159 | Fax: 512-351-8858
 For terms and conditions of sales, please visit:
www.abracon.com

REVISION I.R: 01-31-25

ABRACON IS
 ISO9001-2015
 CERTIFIED

Automotive-Grade UWB 6.24-8.24GHz Chip Antenna



AANI-CH-0136-Q

Request Samples



Check Inventory



3.2 x 1.6 x 1.1 mm
RoHS/RoHS II Compliant
 MSL Level = 1

Ordering Information

Part Number	Description
AANI-CH-0136-Q	Antenna Component on Cut Tape
AANI-CH-0136-Q-T	Antenna Component on Tape & Reel
AANI-CH-0136-Q-EVB	Evaluation Kit

Product Dimensions and Terminal Configuration

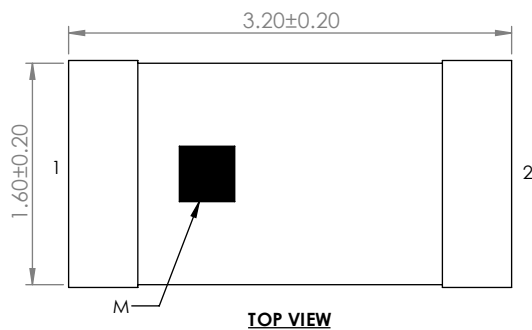

Pin #	Function
1	Feed
2	NC
M	MARK

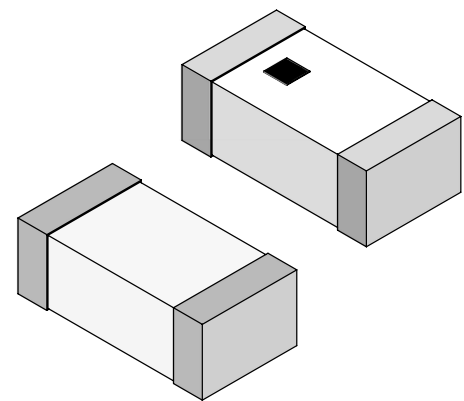
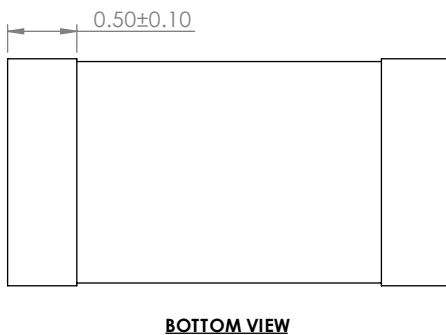
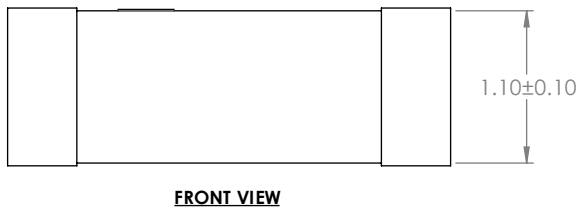

Unit: mm



5101 Hidden Creek Ln Spicewood TX 78669
 Phone: 512-371-6159 | Fax: 512-351-8858
 For terms and conditions of sales, please visit:
www.abracon.com

REVISION I.R: 01-31-25

ABRACON IS
 ISO9001-2015
 CERTIFIED

Automotive-Grade UWB 6.24-8.24GHz Chip Antenna

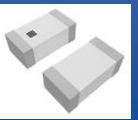

AANI-CH-0136-Q

Request Samples



Check Inventory



3.2 x 1.6 x 1.1 mm
RoHS/RoHS II Compliant
MSL Level = 1

Recommended PCB layout

If there are several layers in the PCB, there is an advantage to add vias for smooth interconnection of the ground areas to avoid splits in the ground plane. It is also important that the ground clearance is respected through **all layers** of the PCB. It is recommended to implement a matching network to optimize the antenna impedance in your application.

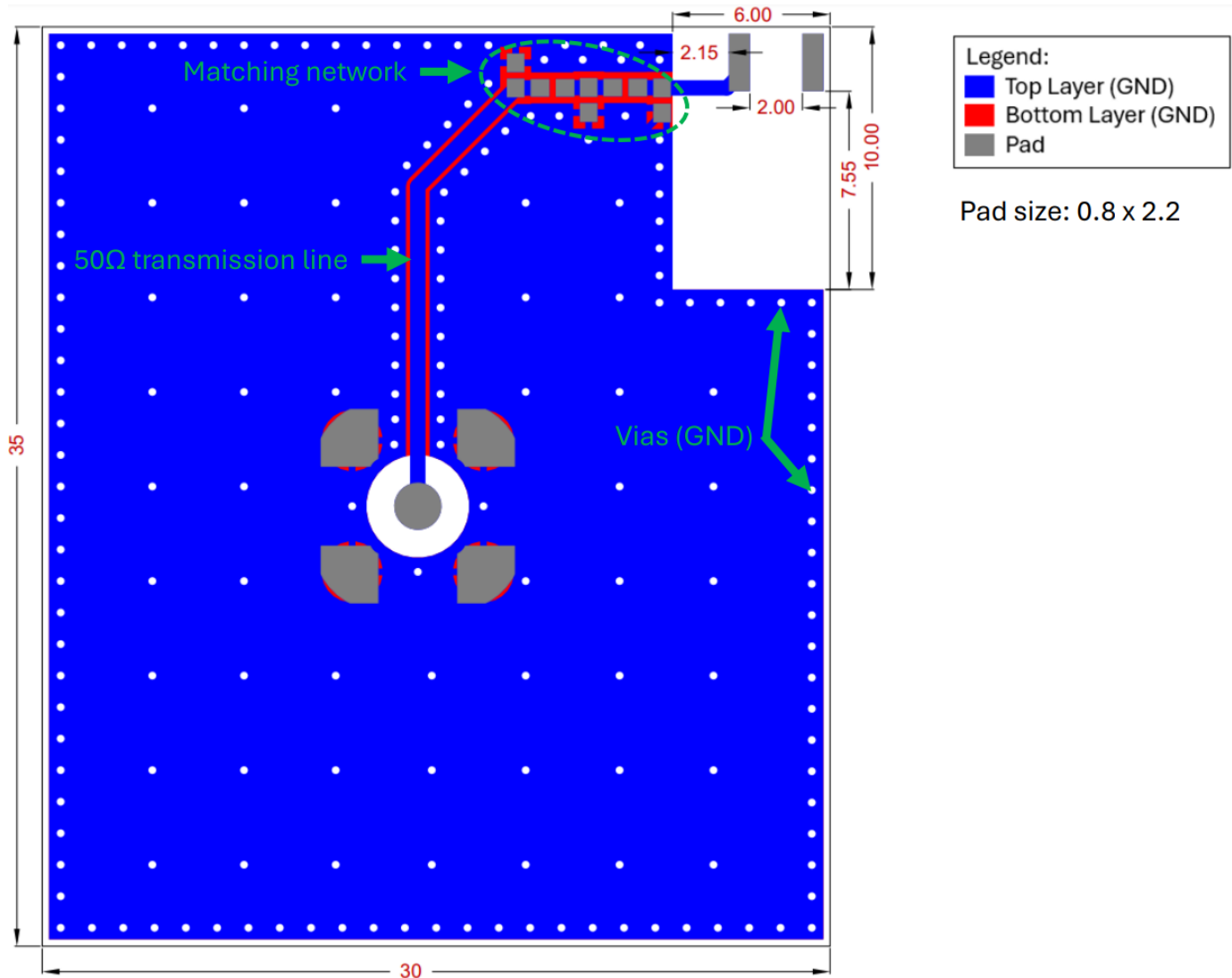

Unit: mm

Transmission Line

The transmission line should be kept as short as possible and be designed to have a characteristic impedance of 50Ω. Abracon recommends using a Co-Planar Waveguide with Ground (CPWG), which dimensions can be derived by any trusted calculator, using the correct input for PCB materials and layer stack-up.



5101 Hidden Creek Ln Spicewood TX 78669
Phone: 512-371-6159 | Fax: 512-351-8858
For terms and conditions of sales, please visit:
www.abracon.com

REVISION I.R: 01-31-25

ABRACON IS
ISO9001-2015
CERTIFIED

Automotive-Grade UWB 6.24-8.24GHz Chip Antenna



AANI-CH-0136-Q

Request Samples



Check Inventory



3.2 x 1.6 x 1.1 mm
RoHS/RoHS II Compliant
MSL Level = 1

Measurement Setup

The radiation measurements were all done in an anechoic chamber with the antenna implemented on its evaluation board (Abracon AANI-CH-0136-Q-EVB) that has a PCB size of 35 x 30 mm:

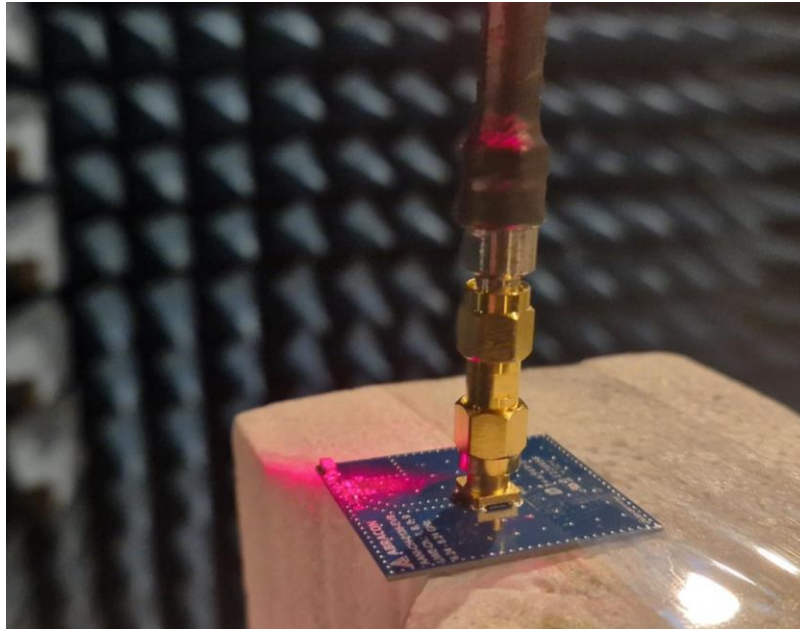

Reflection Characteristics – Return Loss

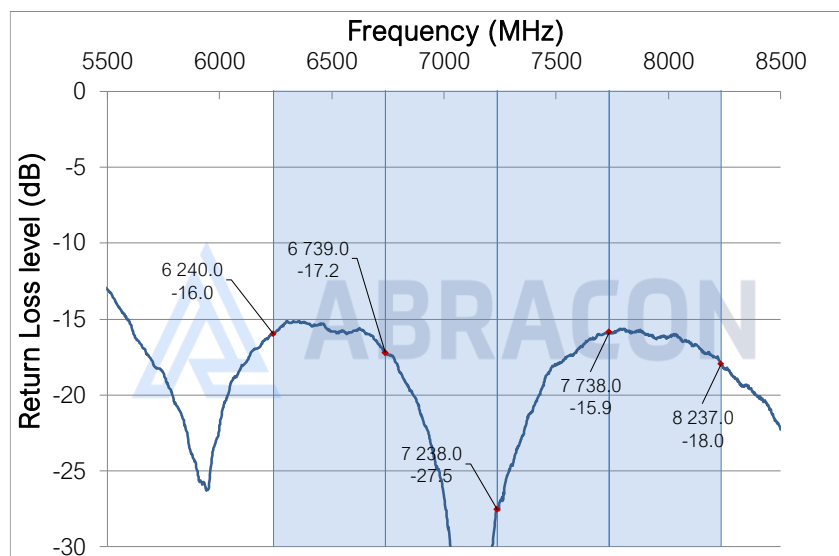

5101 Hidden Creek Ln Spicewood TX 78669
Phone: 512-371-6159 | Fax: 512-351-8858
For terms and conditions of sales, please visit:
www.abracon.com

REVISION I.R.: 01-31-25

ABRACON IS
ISO9001-2015
CERTIFIED

Automotive-Grade UWB 6.24-8.24GHz Chip Antenna



AANI-CH-0136-Q

Request Samples



Check Inventory



3.2 x 1.6 x 1.1 mm
RoHS/RoHS II Compliant
MSL Level = 1

Radiation Characteristics – Total Efficiency (dB)

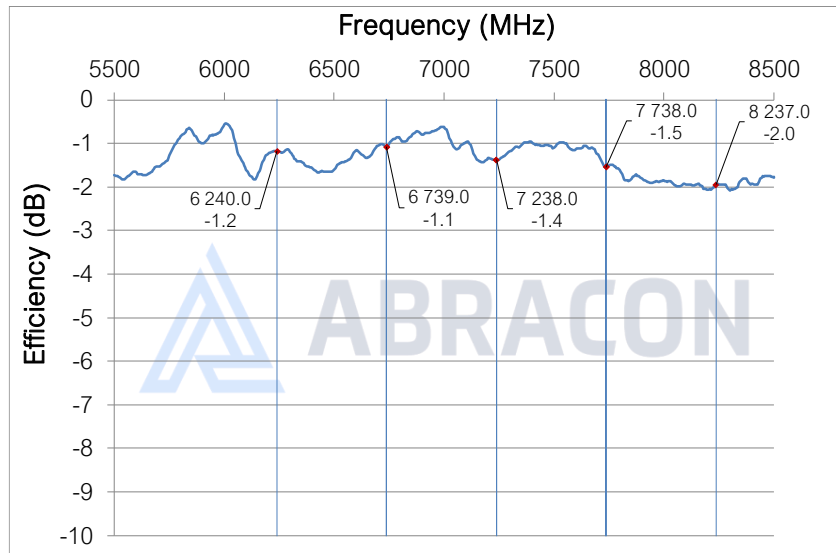

Radiation Characteristics – Total Efficiency (%)

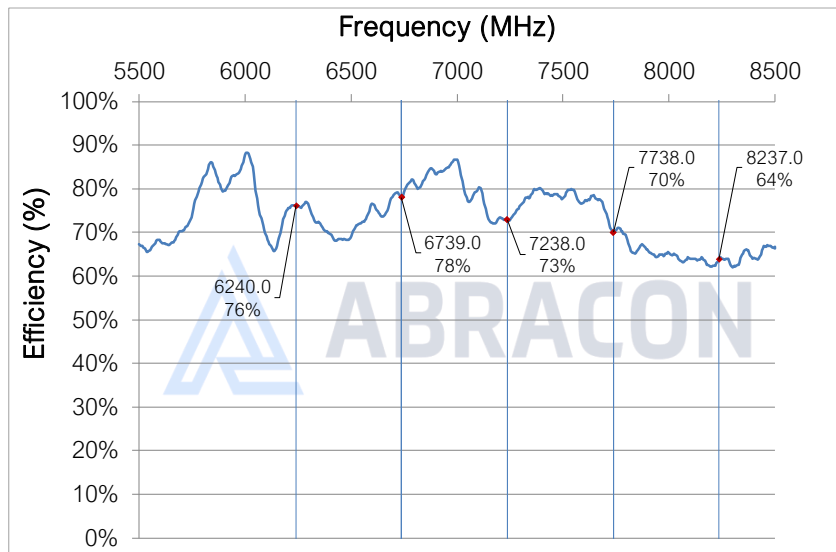

5101 Hidden Creek Ln Spicewood TX 78669
Phone: 512-371-6159 | Fax: 512-351-8858
For terms and conditions of sales, please visit:
www.abracon.com

REVISION I.R: 01-31-25

ABRACON IS
ISO9001-2015
CERTIFIED

Automotive-Grade UWB 6.24-8.24GHz Chip Antenna

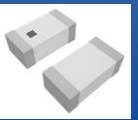

AANI-CH-0136-Q

Request Samples



Check Inventory



3.2 x 1.6 x 1.1 mm
RoHS/RoHS II Compliant
MSL Level = 1

Radiation Characteristics – Maximum Gain

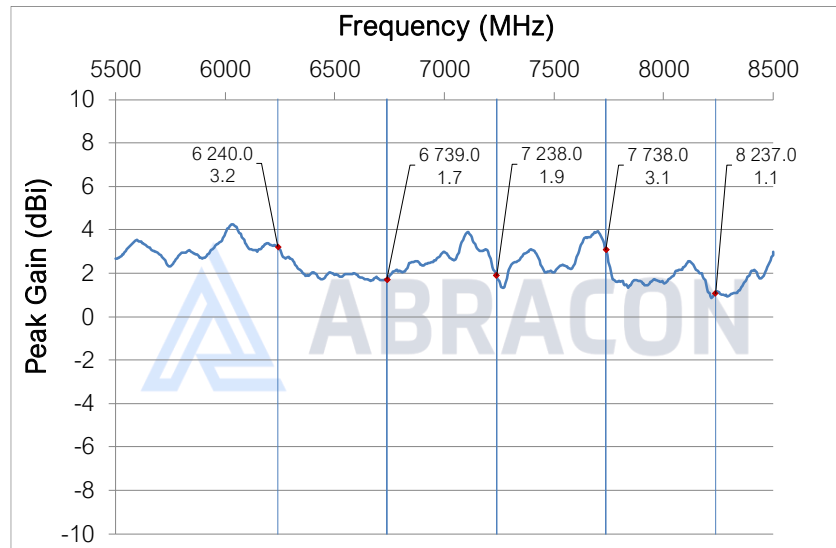

Radiation Characteristics – Group Delay

Two identical antennas were placed a distance d_{sep} apart in an anechoic chamber. The Group Delay, τ_{GD} , is then calculated from the transmission S-parameter (S12) by $\tau_{GD} = -\frac{1}{2\pi} \frac{\Delta\phi}{\Delta f}$, where $\Delta\phi$ is the change of phase over an aperture Δf . The maximum variation in group delay per channel, $\Delta_{max}\tau_{GD}$, can be found in the table below.

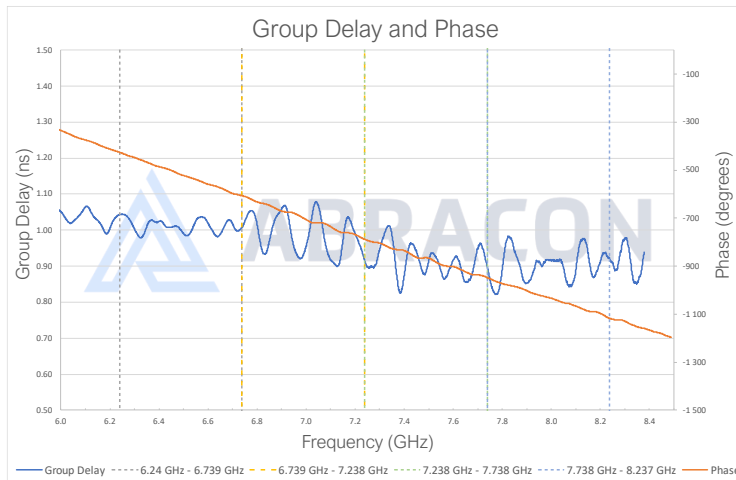

Used Parameters	
Distance d_{sep} (cm)	Aperture Δf (MHz)
50	220

Maximum Group Delay Variation			
UWB Ch.	Freq. Low (GHz)	Freq. High (GHz)	$\Delta_{max}\tau_{GD}$ (ps)
5	6.240	6.739	66
6	6.739	7.238	180
8	7.238	7.738	186
9	7.738	8.237	162



5101 Hidden Creek Ln Spicewood TX 78669
 Phone: 512-371-6159 | Fax: 512-351-8858
 For terms and conditions of sales, please visit:
www.abracon.com

REVISION I.R: 01-31-25

ABRACON IS
 ISO9001-2015
 CERTIFIED

Automotive-Grade UWB 6.24-8.24GHz Chip Antenna



AANI-CH-0136-Q

Request Samples



Check Inventory



3.2 x 1.6 x 1.1 mm
RoHS/RoHS II Compliant
MSL Level = 1

Radiation Characteristics – 3D Pattern (dBi)

6240 MHz

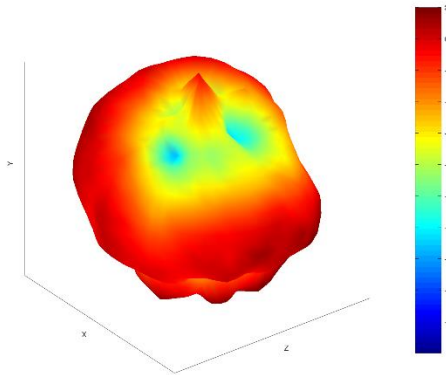

7240 MHz

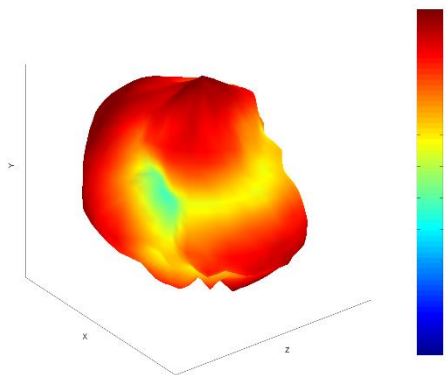

8235 MHz

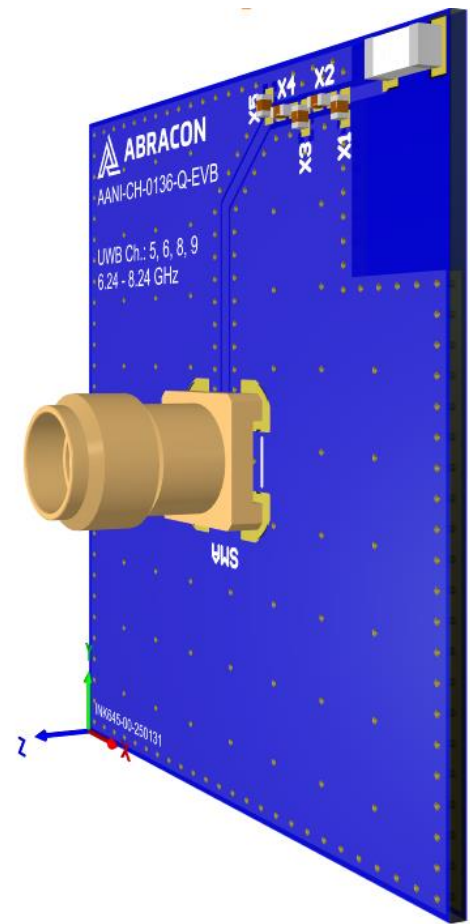
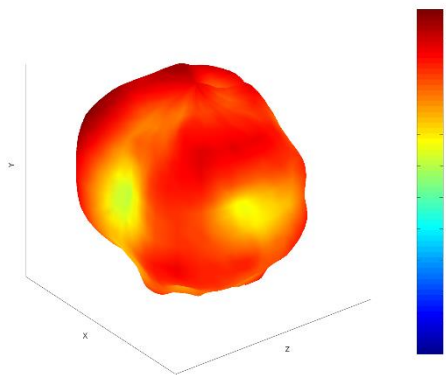

5101 Hidden Creek Ln Spicewood TX 78669
Phone: 512-371-6159 | Fax: 512-351-8858
For terms and conditions of sales, please visit:
www.abracon.com

REVISION I.R: 01-31-25

ABRACON IS
ISO9001-2015
CERTIFIED

Automotive-Grade UWB 6.24-8.24GHz Chip Antenna



AANI-CH-0136-Q

Request Samples



Check Inventory



3.2 x 1.6 x 1.1 mm
RoHS/RoHS II Compliant
MSL Level = 1

Radiation Characteristics – 2D Pattern @ 6240 MHz

XY-plane:

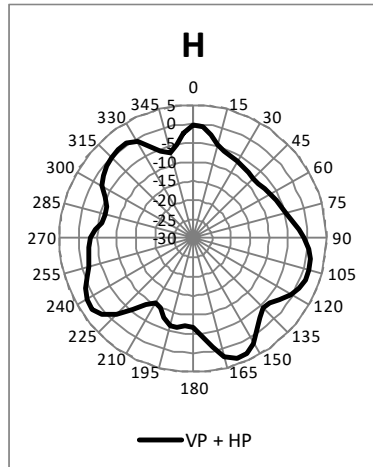

YZ-plane:

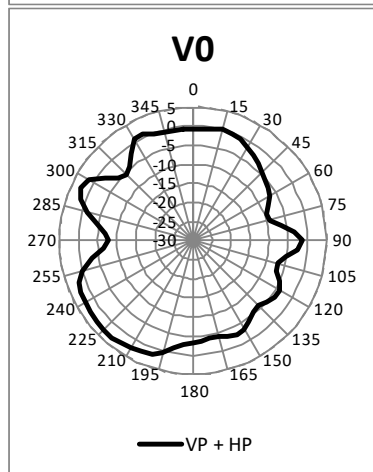

XZ-plane:

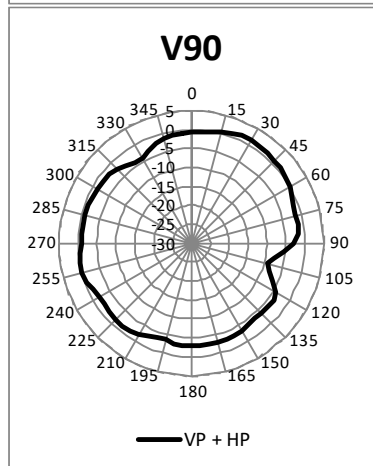

VP: Vertical Polarization
HP: Horizontal Polarization

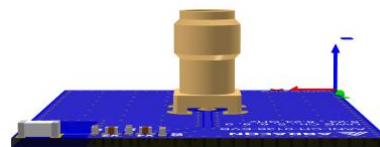
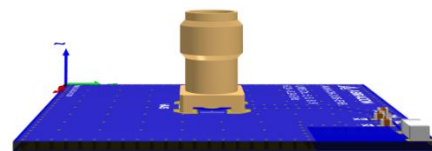

Unit: dBi



5101 Hidden Creek Ln Spicewood TX 78669
 Phone: 512-371-6159 | Fax: 512-351-8858
 For terms and conditions of sales, please visit:
www.abracon.com

REVISION I.R: 01-31-25

ABRACON IS
 ISO9001-2015
 CERTIFIED

Automotive-Grade UWB 6.24-8.24GHz Chip Antenna



AANI-CH-0136-Q

Request Samples



Check Inventory



3.2 x 1.6 x 1.1 mm
RoHS/RoHS II Compliant
MSL Level = 1

Radiation Characteristics – 2D Pattern @ 7240 MHz

XY-plane:

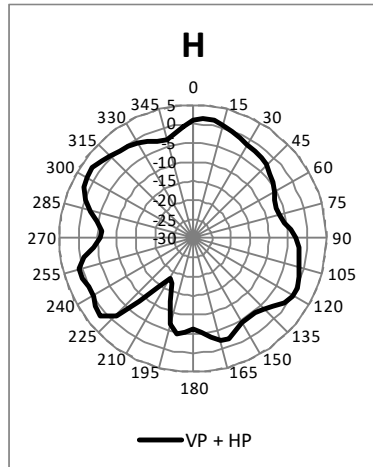

YZ-plane:

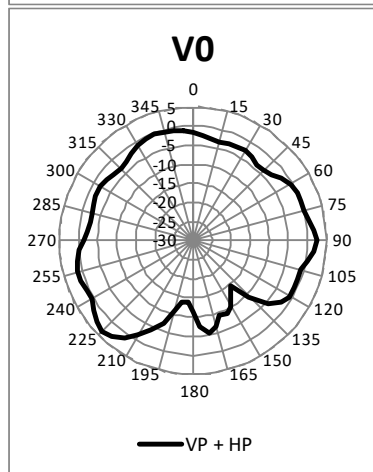

XZ-plane:

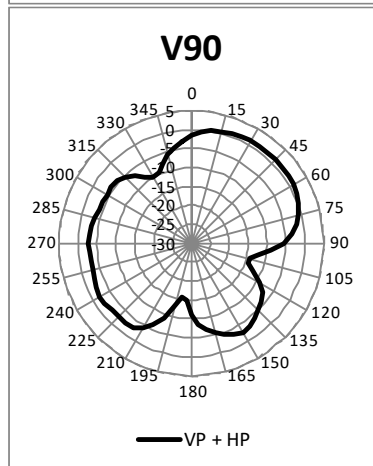

VP: Vertical Polarization
HP: Horizontal Polarization

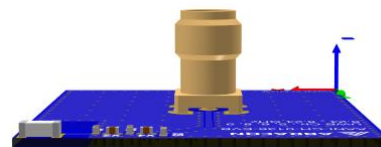
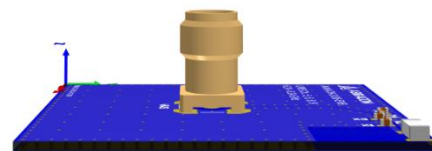

Unit: dBi



5101 Hidden Creek Ln Spicewood TX 78669
 Phone: 512-371-6159 | Fax: 512-351-8858
 For terms and conditions of sales, please visit:
www.abracon.com

REVISION I.R: 01-31-25

ABRACON IS
 ISO9001-2015
 CERTIFIED

Automotive-Grade UWB 6.24-8.24GHz Chip Antenna



AANI-CH-0136-Q

Request Samples



Check Inventory



3.2 x 1.6 x 1.1 mm
RoHS/RoHS II Compliant
MSL Level = 1

Radiation Characteristics – 2D Pattern @ 8235 MHz

XY-plane:

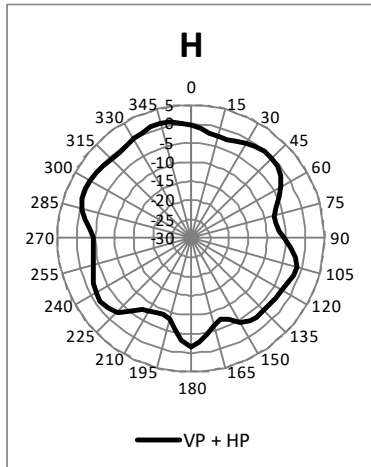

YZ-plane:

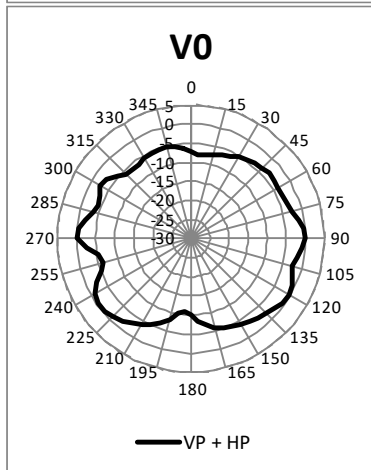

XZ-plane:

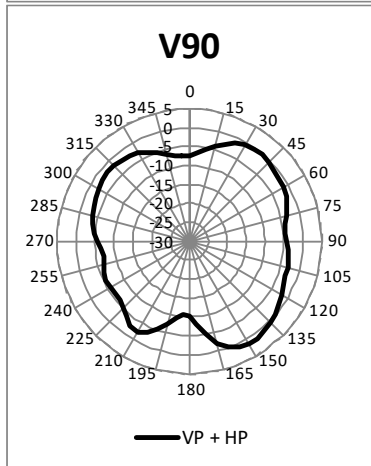

VP: Vertical Polarization
HP: Horizontal Polarization

Unit: dBi

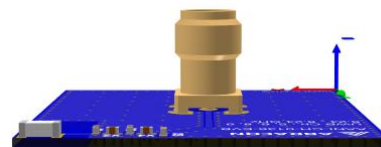
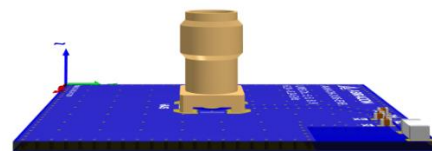

5101 Hidden Creek Ln Spicewood TX 78669
 Phone: 512-371-6159 | Fax: 512-351-8858
 For terms and conditions of sales, please visit:
www.abracon.com

REVISION I.R: 01-31-25

ABRACON IS
 ISO9001-2015
 CERTIFIED

Automotive-Grade UWB 6.24-8.24GHz Chip Antenna

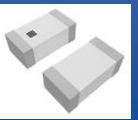

AANI-CH-0136-Q

Request Samples



Check Inventory



3.2 x 1.6 x 1.1 mm
RoHS/RoHS II Compliant
MSL Level = 1

Evaluation Board Outline & Matching Circuit

The evaluation board (Abracon AANI-CH-0136-Q-EVB) is developed to simplify antenna testing and evaluation. It has an arbitrary size of 35 x 30 mm and includes an SMA connector. The purpose is to give a reference design for an optimal antenna implementation. The evaluation board can also be used to test other implementations by cutting and soldering the PCB into any device.

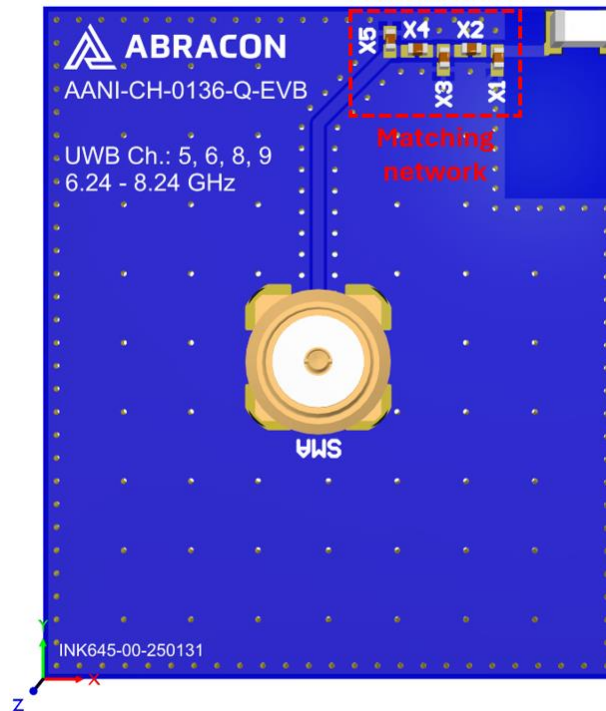

The evaluation board has a matching circuit implemented next to the antenna. This is aimed to enable optimization possibilities for the user. The component positions are sized for 0402 (1005 metric) SMD components.

The antenna requires a matching circuit to fine-tune the resonant frequency and achieve optimal balance. The evaluation board is pre-tuned for optimal performance in the 6.24-8.24 GHz range using the components listed below (equivalents may be used):

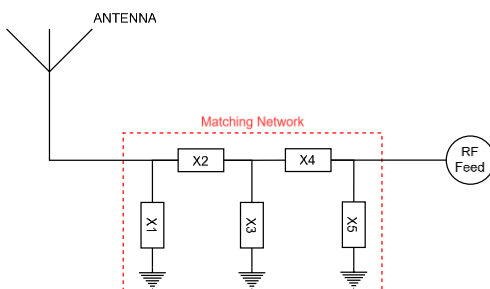

- X1 = Not mounted
- X2 = 0.7 pF (Murata GJM1555C1HR70WB01)
- X3 = 1.7 nH (Murata LQW15AN1N7C00)
- X4 = 0 Ω (KOA Speer RK73Z1ETTP)
- X5 = Not mounted

However, it is common that the resonant frequency will shift during implementation in an arbitrary device. Therefore, this matching may be changed with other values/components/brands for compensation of such effects. This is further described in the General Implementation Guidelines section below.



5101 Hidden Creek Ln Spicewood TX 78669
Phone: 512-371-6159 | Fax: 512-351-8858
For terms and conditions of sales, please visit:
www.abracon.com

REVISION I.R.: 01-31-25

ABRACON IS
ISO9001-2015
CERTIFIED

Automotive-Grade UWB 6.24-8.24GHz Chip Antenna

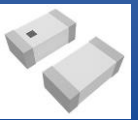

AANI-CH-0136-Q

Request Samples



Check Inventory



3.2 x 1.6 x 1.1 mm
RoHS/RoHS II Compliant
MSL Level = 1

General Implementation Guidelines

The antenna can be positioned in different ways, although there are some positions which are more beneficial. The illustration below shows a typical PCB with examples on different antenna positions:

- Both options are optimal.
- The antenna must be placed along the PCB edge, i.e., it cannot be placed in the middle (see “N/A”).

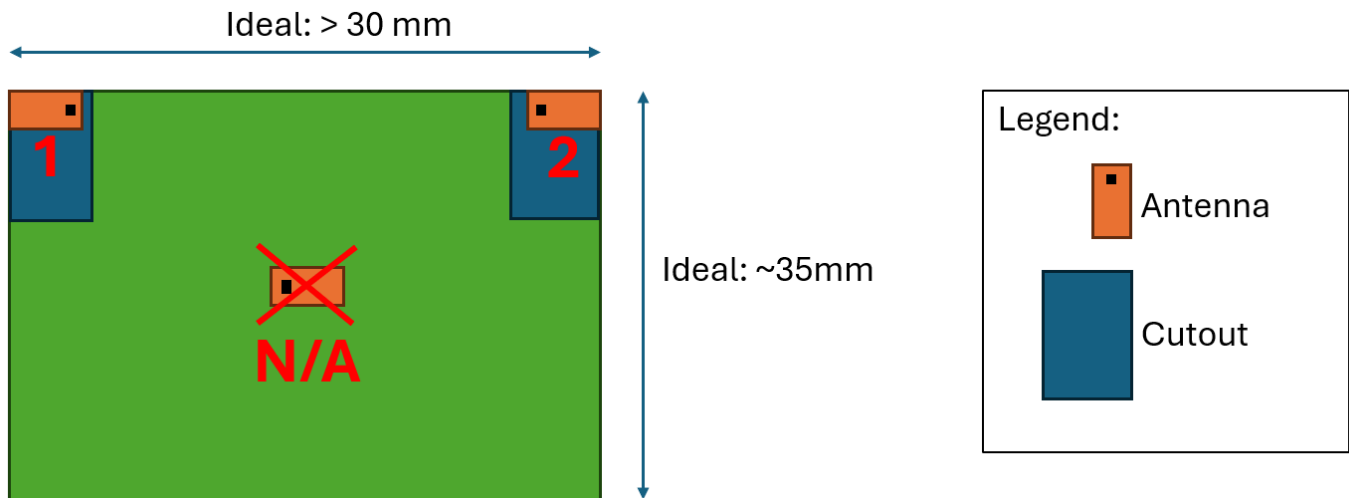

The rectangular copper cutout in the footprint must extend through all layers of the PCB stack-up, ensuring there is **no copper on any layer in this area**. Additionally, a robust via structure around the cutout and along the edge of the ground plane is highly recommended for optimal performance.

It is important to note that plastic and metal parts in close proximity to antennas may significantly affect antenna tuning and performance. For instance, a plastic housing above the antenna often causes the resonant frequency to shift downward. Since such effects are challenging to predict without detailed design information, it is recommended to measure the antenna performance in the final device after implementation. To compensate for potential frequency shifts, implementing a matching network on the antenna feed is advisable.

Another general consideration for surface-mounted antennas relates to PCB population. Electrical components placed near the antenna may impact its tuning and radiation performance. To mitigate this, components in the surrounding area should be positioned below a topographical slope. This slope should begin at the PCB level near the antenna's designated keep-out zone and gradually increase in height as distance from the antenna grows.

For technical assistance, please contact [Abracon online support](#) through our online support platform.



5101 Hidden Creek Ln Spicewood TX 78669
Phone: 512-371-6159 | Fax: 512-351-8858
For terms and conditions of sales, please visit:
www.abracon.com

REVISION I.R: 01-31-25

ABRACON IS
ISO9001-2015
CERTIFIED

Automotive-Grade UWB 6.24-8.24GHz Chip Antenna

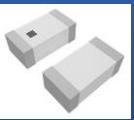

AANI-CH-0136-Q

Request Samples



Check Inventory



3.2 x 1.6 x 1.1 mm
RoHS/RoHS II Compliant
MSL Level = 1

Reflow Profile [JEDEC J-STD-020]

Solder paste: Sn/3.0Ag/0.5Cu

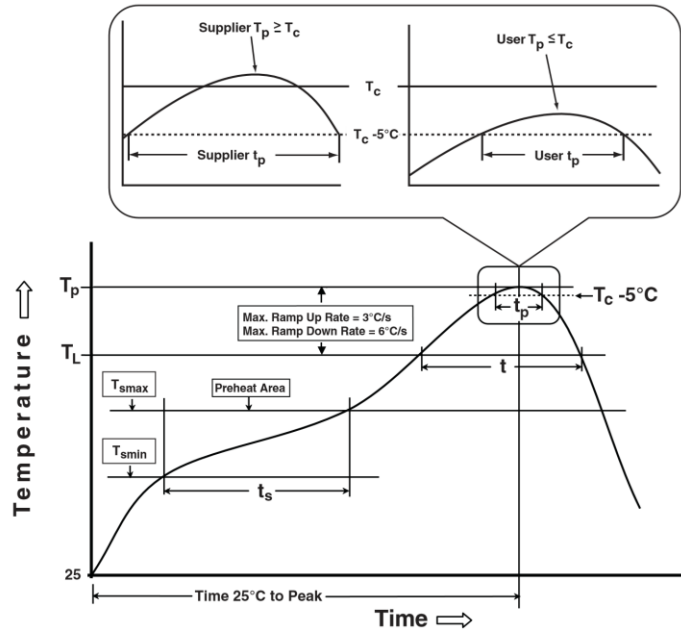

Table 1

SnPb Eutectic Process Classification Temperatures (T_c)		
Package Thickness	Volume mm^3 <350	Volume mm^3 ≥ 350
<2.5mm	235°C	220°C
$\geq 2.5mm$	220°C	220°C

Table 2

Pb-Free Process Classification Temperatures (T_c)			
Package Thickness	Volume mm^3 <350	Volume mm^3 350-2000	Volume mm^3 >2000
<1.6mm	260°C	260°C	260°C
1.6mm - 2.5mm	260°C	250°C	245°C
>2.5mm	250°C	245°C	245°C

Profile Feature	Sn-Pb Eutectic Assembly	Pb-Free Assembly
Preheat / soak		
Temperature minimum (T_{smin})	100°C	150°C
Temperature maximum (T_{smax})	150°C	200°C
Time (T_{smin} to T_{smax}) (t_s)	60 – 120 sec.	60 – 90 sec.
Average ramp-up rate (T_{smax} to T_p)	3°C/sec. max	3°C/sec. max
Liquidous temperature (T_L)	183°C	217°C
Time at Liquidous (T_L)	60 – 150 sec.	60 – 150 sec.
Peak package body temperature (T_p)*	See Table 1	See Table 2
Time (T_p)** within 5°C of the specified classification temperature (T_c)	20 sec.	10 sec.
Ramp-down rate (T_p to T_{smax})	6°C/sec. max	6°C/sec. max
Time 25°C to peak temperature	6 min. max	8 min. max
Reflow cycles	2 max	2 max

*Tolerance for peak profile temperature (T_p) is defined as a supplier minimum and a user maximum.

**Tolerance for time at peak profile temperature (t_p) is defined as a supplier minimum and a user maximum.



5101 Hidden Creek Ln Spicewood TX 78669
Phone: 512-371-6159 | Fax: 512-351-8858
For terms and conditions of sales, please visit:
www.abracon.com

REVISION I.R: 01-31-25

ABRACON IS
ISO9001-2015
CERTIFIED

Automotive-Grade UWB 6.24-8.24GHz Chip Antenna

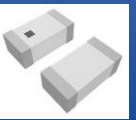

AANI-CH-0136-Q

Request Samples



Check Inventory



3.2 x 1.6 x 1.1 mm
RoHS/RoHS II Compliant
MSL Level = 1

Packaging

Tape & Reel dimensions:

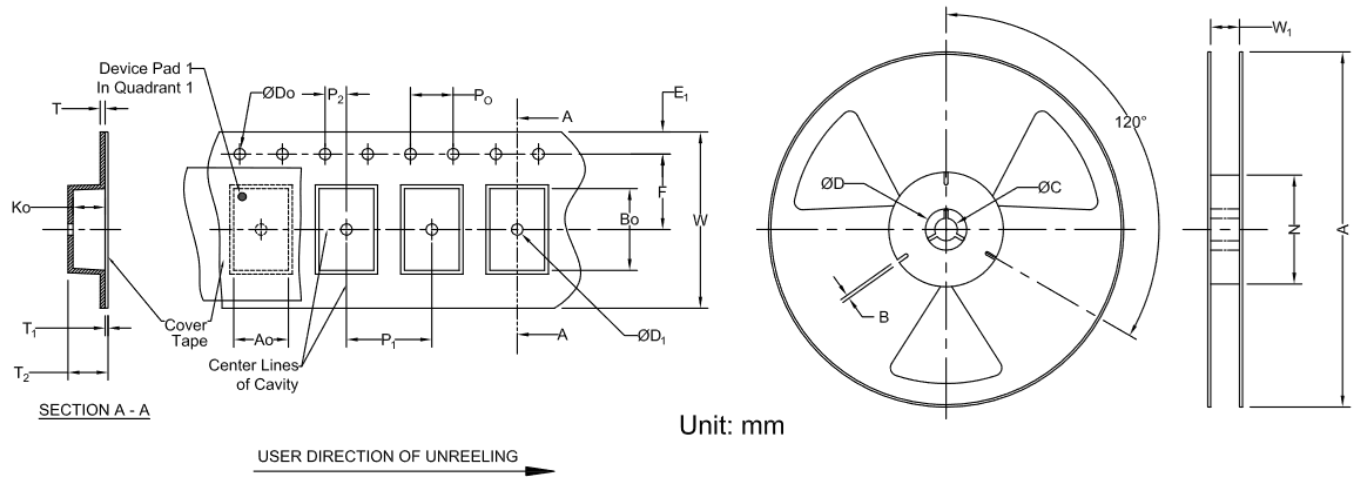

Carrier Tape Specifications (mm)

Do	K ₀	E ₁	P ₀	T	F	P ₁	W	A ₀	B ₀	Reel Qty
1.50 ± 0.1	1.5 ± 0.1	1.75 ± 0.1	4.0 ± 0.1	0.22 ± 0.05	3.5 ± 0.2	4.0 ± 0.1	8.0 ± 0.1	1.8 ± 0.1	3.5 ± 0.1	3,000

Reel Specifications (mm)

A	W ₁	N	B
178 ± 2.0	8.4 ± 1.5	58 ± 2.0	2.45 ± 0.2

ATTENTION: Abracon LLC's products are Commercial-Off-The-Shelf ('COTS'), which are designed, intended, and validated for use in commercial, industrial, and automotive applications. The customer is responsible for testing and verifying the performance of an Abracon solution to meet their system-level requirements.



5101 Hidden Creek Ln Spicewood TX 78669
 Phone: 512-371-6159 | Fax: 512-351-8858
 For terms and conditions of sales, please visit:
www.abracon.com

REVISION I.R: 01-31-25

ABRACON IS
 ISO9001-2015
 CERTIFIED