

2.4GHz Loop Chip Antenna



AANI-CH-0070

Request Samples



Check Inventory



1.0 x 0.5 x 0.4 mm
RoHS/RoHS II Compliant
MSL Level = 1

Features

- Miniature Form Factor: 1.0 x 0.5 x 0.4 mm
- Low Return Loss of: ≤ -7.2 dB
- Peak Gain: 2.8 dBi
- Average Total Efficiency: -1.6 dB (70%)
- Linear Polarization
- Surface Mount (SMD)
- Integration: PCB Edge Mounting

Applications

- Bluetooth®/ ZigBee® / Thread/ Matter/Wi-Fi®
- Bluetooth®/ Wi-Fi® Modules
- Consumer Hearables & Wearables
- Medical Wearables & Tele-Medicine
- Smart Home & Smart Building
- Asset Tracking & Telematics
- Smart Metering
- Intelligent Lighting
- Wireless Remote Control

Product Image

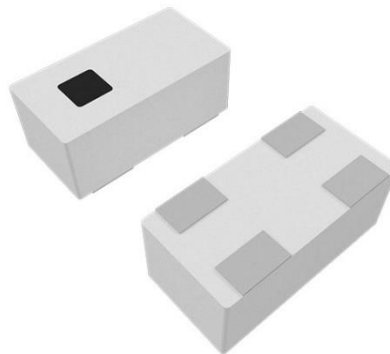

2.4GHz Loop Chip Antenna



AANI-CH-0070

Request Samples



Check Inventory



1.0 x 0.5 x 0.4 mm
RoHS/RoHS II Compliant
MSL Level = 1

Electrical Specification

Parameter	Specification	Unit
Operating Frequency	2400 - 2500	MHz
Return Loss	≤ -7.2	dB
VSWR	≤ 2.5	:1
Polarization	Linear	-
Peak Gain	2.8	dBi
Minimum Total Efficiency	-1.8 (66)	dB (%)
Average Total Efficiency	-1.6 (70)	dB (%)
Maximum Total Efficiency	-1.4 (72)	dB (%)
Impedance	50	Ω
Radiation Pattern	Omni-directional	-
Input Power	≤ 2.0	W

Note: All measurements were performed using the evaluation board in a free-space environment. Actual performance may vary depending on factors such as the ground plane, specific application, and surrounding environment.

Mechanical Specification

Parameter	Specification
Antenna Dimension	1.0 x 0.5 x 0.4 mm
Evaluation board Dimension	44 x 19 mm
Recommended Ground Clearance for Antenna	4.6 x 3.5 mm
Mounting Type	Surface Mount
Mounting Location	PCB Edge Mounting
Material(s)	Ceramic

Environmental Specification

Parameter	Specification
Operating and Storage Temperature (individual chip without packing)	-40°C ~ +85°C
Packaging Storage Temperature	-10°C ~ +40°C
Packaging Storage Relative Humidity	70% (Max.)

Ordering Information

Part Number	Description
AANI-CH-0070	Antenna Component on Cut Tape
AANI-CH-0070-T	Antenna Component on Tape & Reel
AANI-CH-0070-EVB	Evaluation Kit



5101 Hidden Creek Ln Spicewood TX 78669
Phone: 512-371-6159 | Fax: 512-351-8858
For terms and conditions of sales, please visit:
www.abracon.com

REVISION A: 12-20-24

ABRACON IS
ISO9001-2015
CERTIFIED

2.4GHz Loop Chip Antenna



AANI-CH-0070

Request Samples



Check Inventory



1.0 x 0.5 x 0.4 mm
RoHS/RoHS II Compliant
MSL Level = 1

Product Dimensions and Terminal Configuration

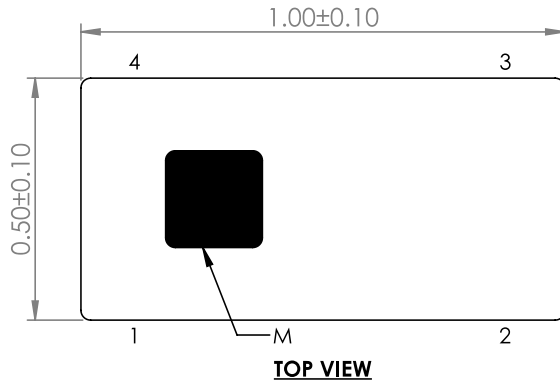

Pin #	Function
1	FEED
2	GND
3	GND
4	FEED
M	MARK

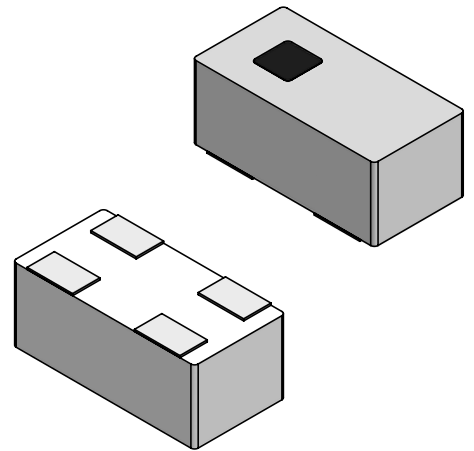
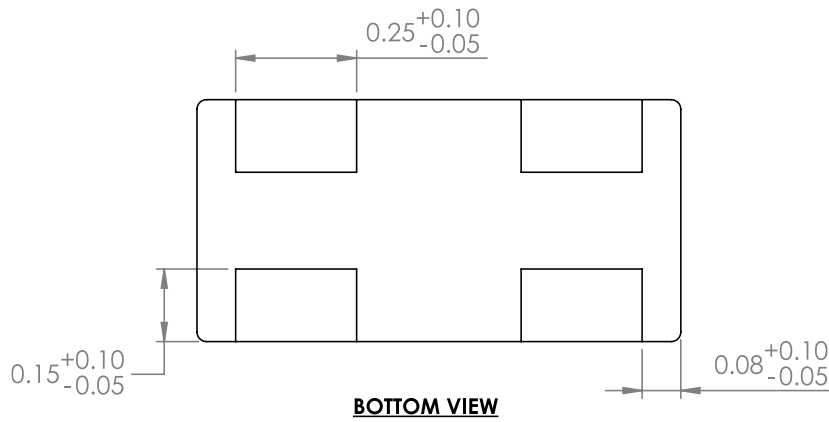
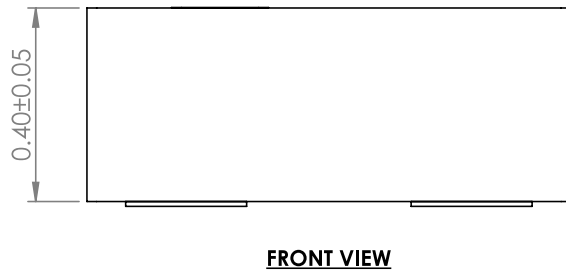

Unit: mm

2.4GHz Loop Chip Antenna



AANI-CH-0070

Request Samples



Check Inventory



1.0 x 0.5 x 0.4 mm
RoHS/RoHS II Compliant
MSL Level = 1

Recommended PCB layout

If there are several layers in the PCB, there is an advantage to add vias for smooth interconnection of the ground areas to avoid splits in the ground plane. It is also important that the ground clearance is respected through all layers of the PCB. It is recommended to implement a matching network to optimize the antenna impedance in your application.

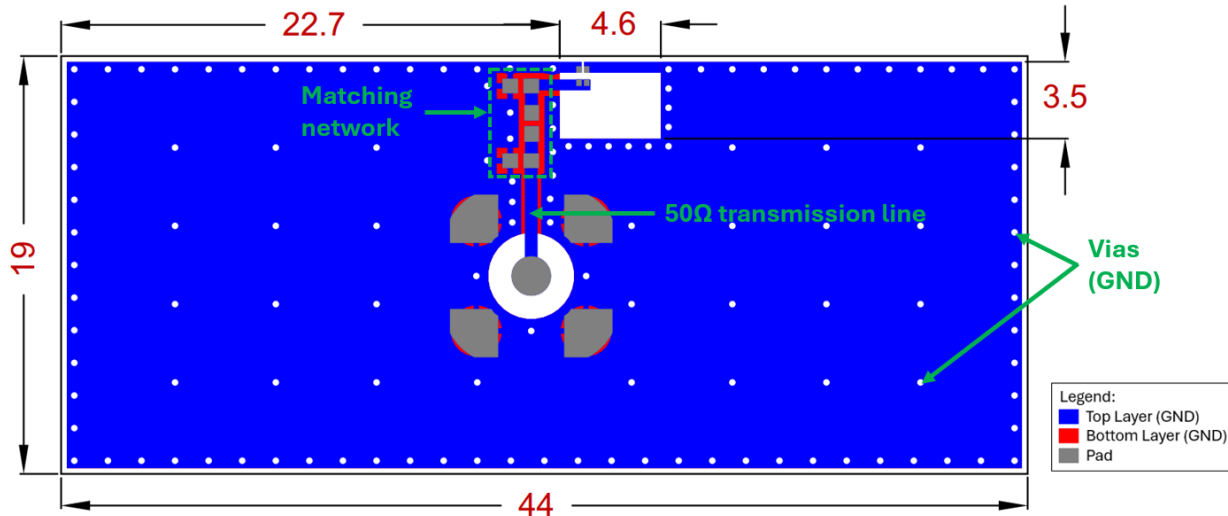

Detailed view of the antenna footprint and ground clearance area:

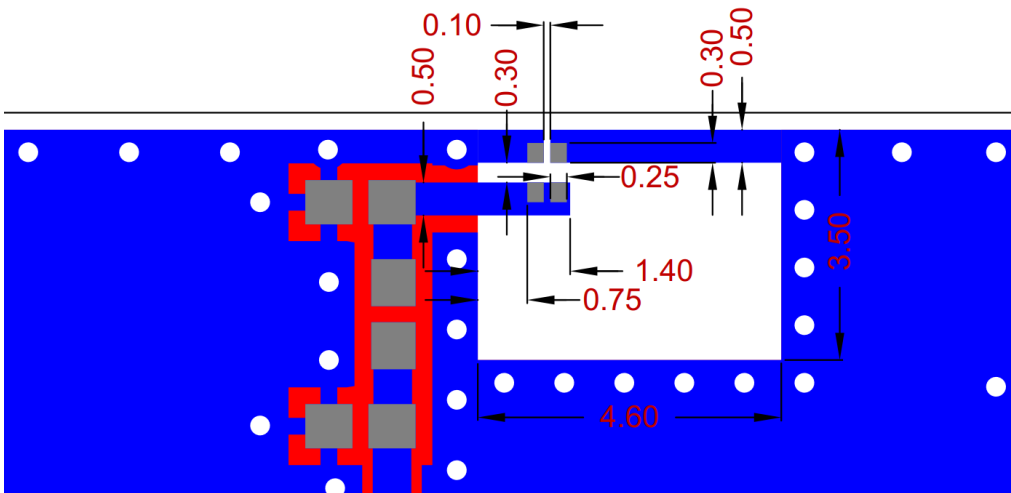

Unit: mm

Transmission Line

The transmission line should be kept as short as possible and be designed to have a characteristic impedance of 50Ω. Abracon recommends using a Co-Planar Waveguide with Ground (CPWG), which dimensions can be derived by any trusted calculator, using the correct input for PCB materials and layer stack-up.



5101 Hidden Creek Ln Spicewood TX 78669
Phone: 512-371-6159 | Fax: 512-351-8858
For terms and conditions of sales, please visit:
www.abracon.com

REVISION A: 12-20-24

ABRACON IS
ISO9001-2015
CERTIFIED

2.4GHz Loop Chip Antenna



AANI-CH-0070

Request Samples



Check Inventory



1.0 x 0.5 x 0.4 mm
RoHS/RoHS II Compliant
MSL Level = 1

Measurement Setup

The radiation measurements were all done in an anechoic chamber with the antenna implemented on its evaluation board (Abracon AANI-CH-0070-EVB) that has a PCB size of 44 x 19 mm:

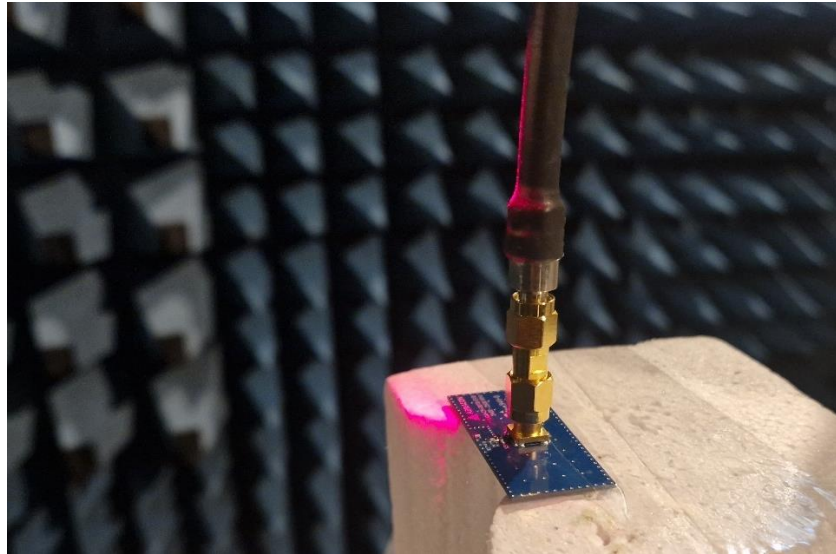

Reflection Characteristics – Return Loss

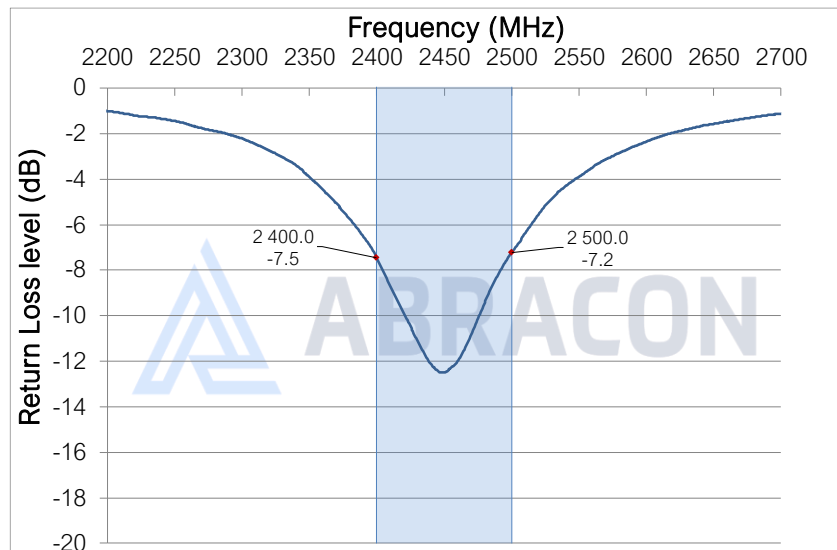

5101 Hidden Creek Ln Spicewood TX 78669
Phone: 512-371-6159 | Fax: 512-351-8858
For terms and conditions of sales, please visit:
www.abracon.com

REVISION A: 12-20-24

ABRACON IS
ISO9001-2015
CERTIFIED

2.4GHz Loop Chip Antenna



AANI-CH-0070

Request Samples



Check Inventory



1.0 x 0.5 x 0.4 mm
RoHS/RoHS II Compliant
MSL Level = 1

Radiation Characteristics – Total Efficiency (dB)

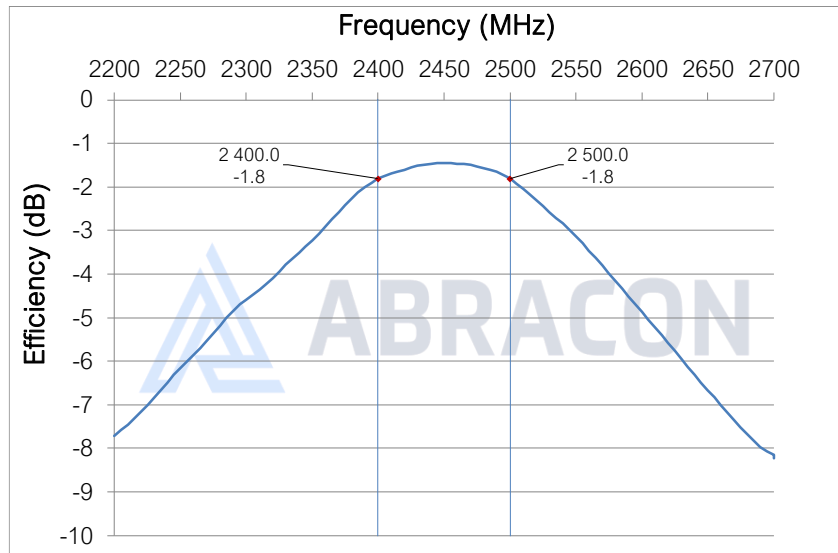

Radiation Characteristics – Total Efficiency (%)

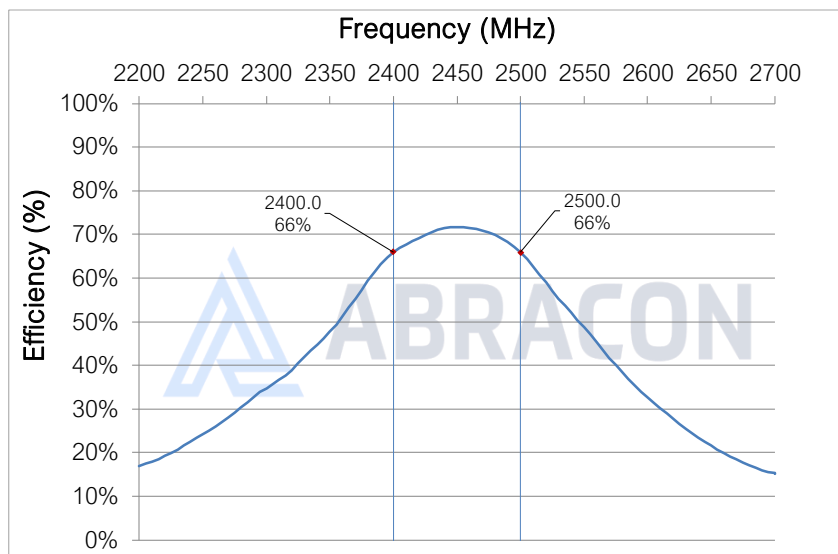

5101 Hidden Creek Ln Spicewood TX 78669
Phone: 512-371-6159 | Fax: 512-351-8858
For terms and conditions of sales, please visit:
www.abracon.com

REVISION A: 12-20-24

ABRACON IS
ISO9001-2015
CERTIFIED

2.4GHz Loop Chip Antenna



AANI-CH-0070

Request Samples



Check Inventory



1.0 x 0.5 x 0.4 mm
RoHS/RoHS II Compliant
MSL Level = 1

Radiation Characteristics – Maximum Gain

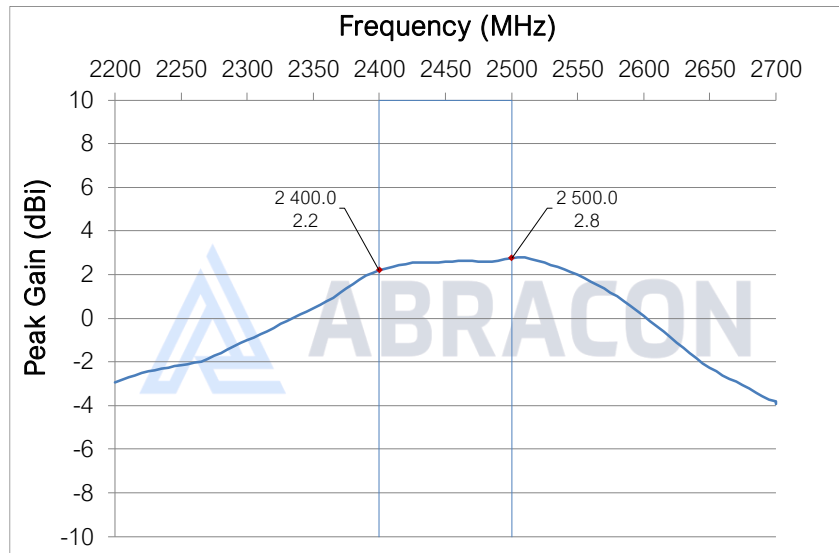

Radiation Characteristics – 3D Pattern @ 2450 MHz

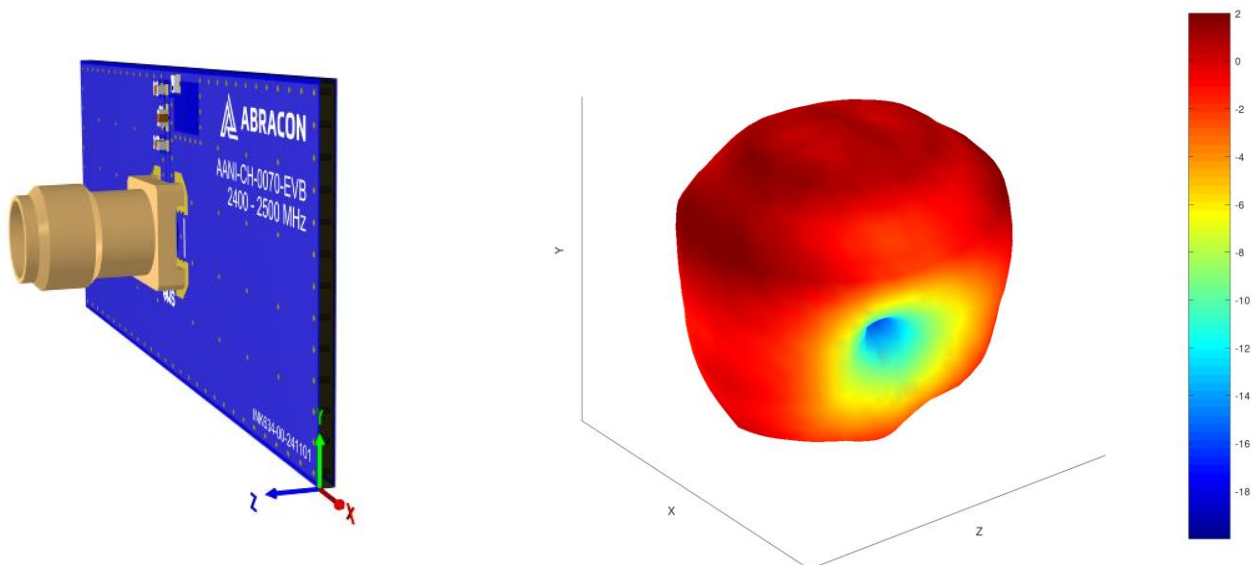

5101 Hidden Creek Ln Spicewood TX 78669
Phone: 512-371-6159 | Fax: 512-351-8858
For terms and conditions of sales, please visit:
www.abracon.com

REVISION A: 12-20-24

ABRACON IS
ISO9001-2015
CERTIFIED

2.4GHz Loop Chip Antenna



AANI-CH-0070

Request Samples



Check Inventory



1.0 x 0.5 x 0.4 mm
RoHS/RoHS II Compliant
MSL Level = 1

Radiation Characteristics – 2D Pattern @ 2450 MHz

XY-plane:

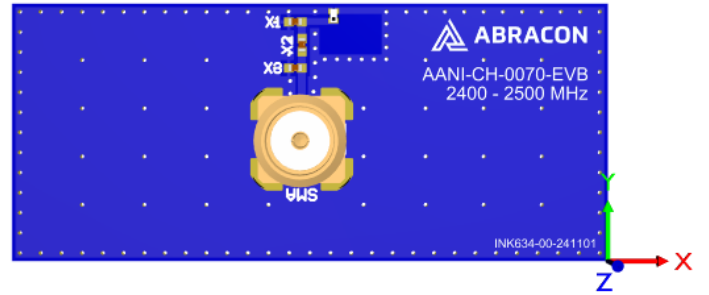
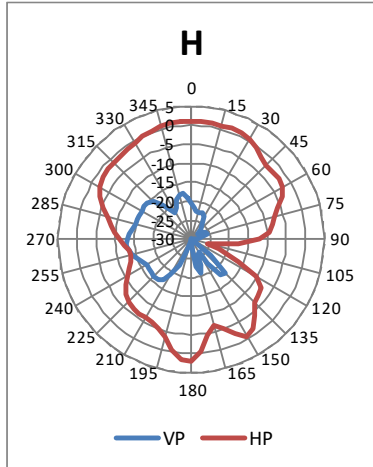

YZ-plane:

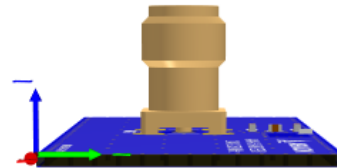
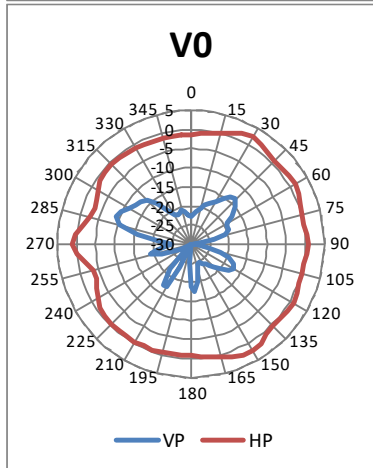

XZ-plane:

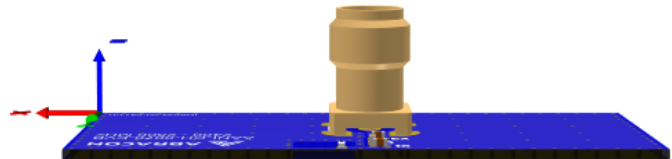
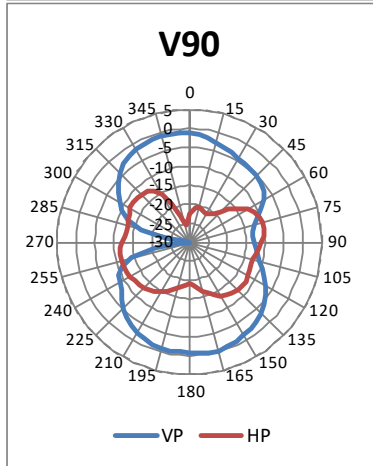

VP: Vertical Polarization
HP: Horizontal Polarization

Unit: dBi



5101 Hidden Creek Ln Spicewood TX 78669
Phone: 512-371-6159 | Fax: 512-351-8858
For terms and conditions of sales, please visit:
www.abracon.com

REVISION A: 12-20-24

ABRACON IS
ISO9001-2015
CERTIFIED

2.4GHz Loop Chip Antenna



AANI-CH-0070

Request Samples



Check Inventory



1.0 x 0.5 x 0.4 mm
RoHS/RoHS II Compliant
MSL Level = 1

Evaluation Board Outline & Matching Circuit

The evaluation board (Abracon AANI-CH-0070-EVB) is developed to simplify antenna testing and evaluation. It has an arbitrary size of 44 x 19 mm and includes an SMA connector. The purpose is to give a reference design for an optimal antenna implementation. The evaluation board can also be used to test other implementations by cutting and soldering the PCB into any device.

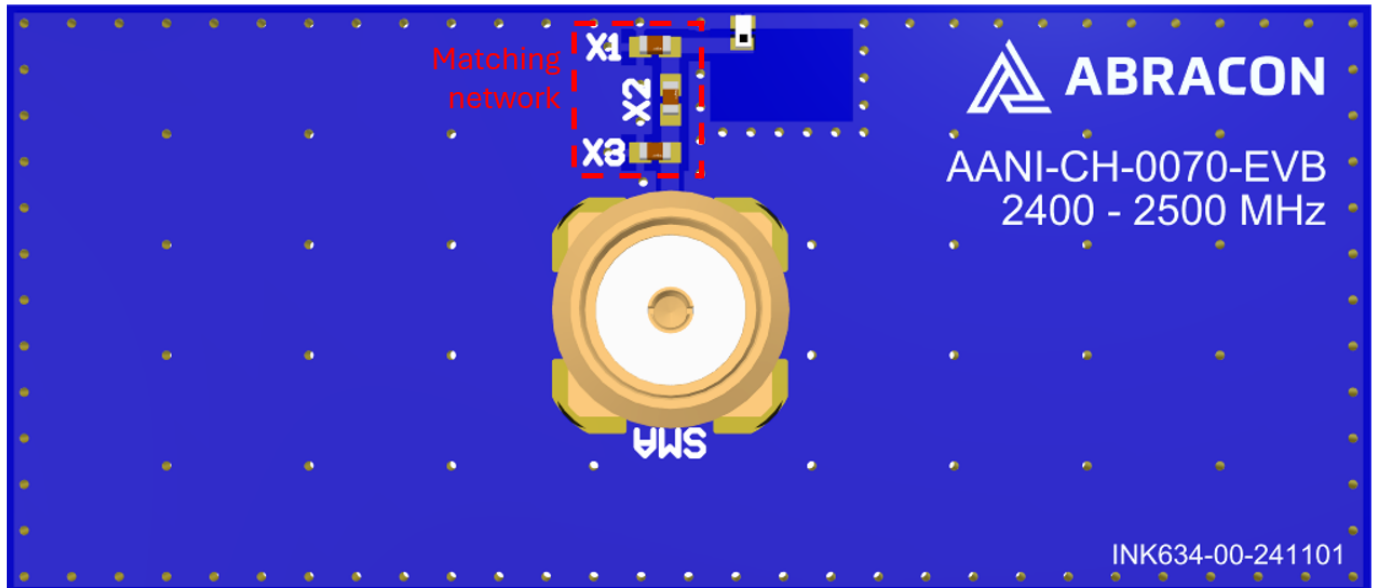

The evaluation board has a matching circuit implemented next to the antenna. This is aimed to enable optimization possibilities for the user. The component positions are sized for 0402 (1005 metric) SMD components.

The antenna requires a matching circuit to fine-tune the resonant frequency and achieve optimal balance. The evaluation board is pre-tuned for optimal performance in the 2.4–2.5 GHz range using the components listed below (equivalents may be used):

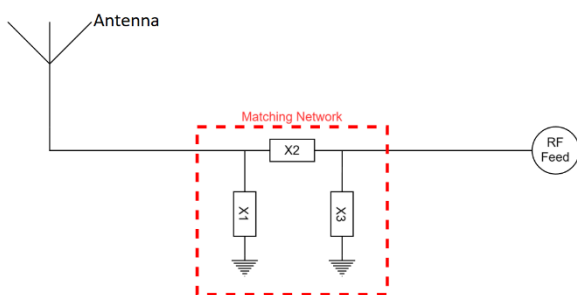

- X1 = not mounted
- X2 = 5.1 pF (Murata GJM1555C1H5R1WB01)
- X3 = 2.2 nH (Murata LQW15AN2N2C10)

However, it is common that the resonant frequency will shift during implementation in an arbitrary device. Therefore, this matching may be changed with other values/components/brands for compensation of such effects. This is further described in the General Implementation Guidelines section below.



5101 Hidden Creek Ln Spicewood TX 78669
Phone: 512-371-6159 | Fax: 512-351-8858
For terms and conditions of sales, please visit:
www.abracon.com

REVISION A: 12-20-24

ABRACON IS
ISO9001-2015
CERTIFIED

2.4GHz Loop Chip Antenna



AANI-CH-0070

Request Samples



Check Inventory



1.0 x 0.5 x 0.4 mm
RoHS/RoHS II Compliant
MSL Level = 1

General Implementation Guidelines

The antenna can be positioned in different ways, although there are some positions which are more beneficial. The below illustration shows a typical PCB with examples on different antenna positions (the GND cutout is not visualized):

- The optimal position is usually option 1. Options 2 and 3 are also possible.
- The antenna must be placed along the PCB edge, i.e., it cannot be placed in the middle (see “N/A”).
- Option 2 or 3 may be the best option for PCB's much larger than the evaluation board.

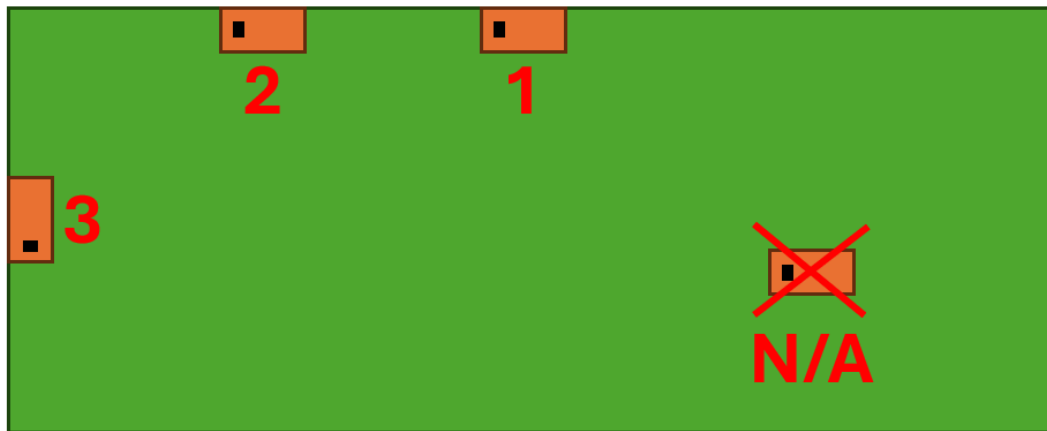

The rectangular copper cutout in the footprint must extend through all layers of the PCB stack-up, ensuring there is **no copper on any layer in this area**. Additionally, a robust via structure around the cutout and along the edge of the ground plane is highly recommended for optimal performance.

It is important to note that plastic and metal parts in close proximity to antennas may significantly affect antenna tuning and performance. For instance, a plastic housing above the antenna often causes the resonant frequency to shift downward. Since such effects are challenging to predict without detailed design information, it is recommended to measure the antenna performance in the final device after implementation. To compensate for potential frequency shifts, implementing a matching network on the antenna feed is advisable.

Another general consideration for surface-mounted antennas relates to PCB population. Electrical components placed near the antenna may impact its tuning and radiation performance. To mitigate this, components in the surrounding area should be positioned below a topographical slope. This slope should begin at the PCB level near the antenna's designated keep-out zone and gradually increase in height as distance from the antenna grows.

For technical assistance, please contact [Abracon online support](#) through our online support platform.

2.4GHz Loop Chip Antenna



AANI-CH-0070

Request Samples



Check Inventory



1.0 x 0.5 x 0.4 mm
RoHS/RoHS II Compliant
MSL Level = 1

Reflow Profile [JEDEC J-STD-020]

Solder paste: Sn/3.0Ag/0.5Cu

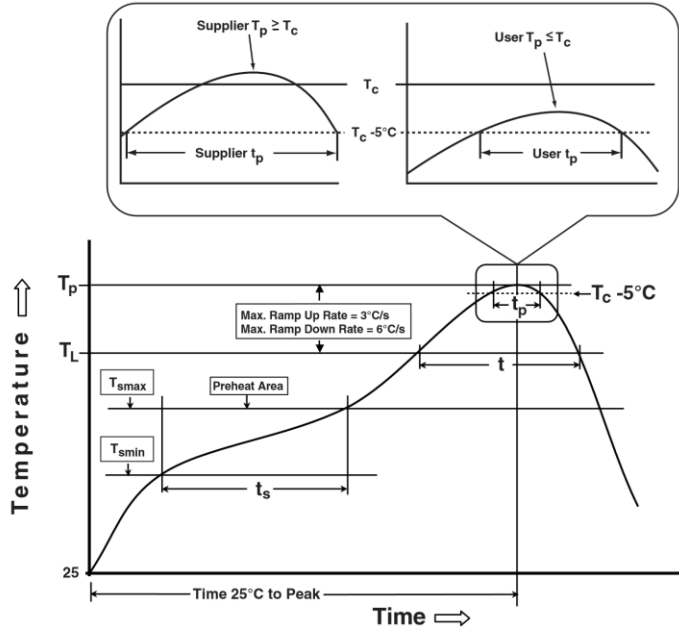

Table 1

SnPb Eutectic Process Classification Temperatures (T_c)		
Package Thickness	Volume mm^3 <350	Volume mm^3 \geq 350
<2.5mm	235°C	220°C
\geq 2.5mm	220°C	220°C

Table 2

Pb-Free Process Classification Temperatures (T_c)			
Package Thickness	Volume mm^3 <350	Volume mm^3 350-2000	Volume mm^3 >2000
<1.6mm	260°C	260°C	260°C
1.6mm - 2.5mm	260°C	250°C	245°C
>2.5mm	250°C	245°C	245°C

Profile Feature	Sn-Pb Eutectic Assembly	Pb-Free Assembly
Preheat / soak		
Temperature minimum (T_{smin})	100°C	150°C
Temperature maximum (T_{smax})	150°C	200°C
Time (T_{smin} to T_{smax}) (t_s)	60 – 120 sec.	60 – 90 sec.
Average ramp-up rate (T_{smax} to T_p)	3°C/sec. max	3°C/sec. max
Liquidous temperature (T_L)	183°C	217°C
Time at Liquidous (T_L)	60 – 150 sec.	60 – 150 sec.
Peak package body temperature (T_p)*	See Table 1	See Table 2
Time (T_p)** within 5°C of the specified classification temperature (T_c)	20 sec.	10 sec.
Ramp-down rate (T_p to T_{smax})	6°C/sec. max	6°C/sec. max
Time 25°C to peak temperature	6 min. max	8 min. max
Reflow cycles	2 max	2 max

*Tolerance for peak profile temperature (T_p) is defined as a supplier minimum and a user maximum.

**Tolerance for time at peak profile temperature (t_p) is defined as a supplier minimum and a user maximum.



5101 Hidden Creek Ln Spicewood TX 78669
 Phone: 512-371-6159 | Fax: 512-351-8858
 For terms and conditions of sales, please visit:
www.abracon.com

REVISION A: 12-20-24

ABRACON IS
 ISO9001-2015
 CERTIFIED

2.4GHz Loop Chip Antenna



AANI-CH-0070

Request Samples



Check Inventory



1.0 x 0.5 x 0.4 mm
RoHS/RoHS II Compliant
MSL Level = 1

Packaging

Tape & Reel dimensions:

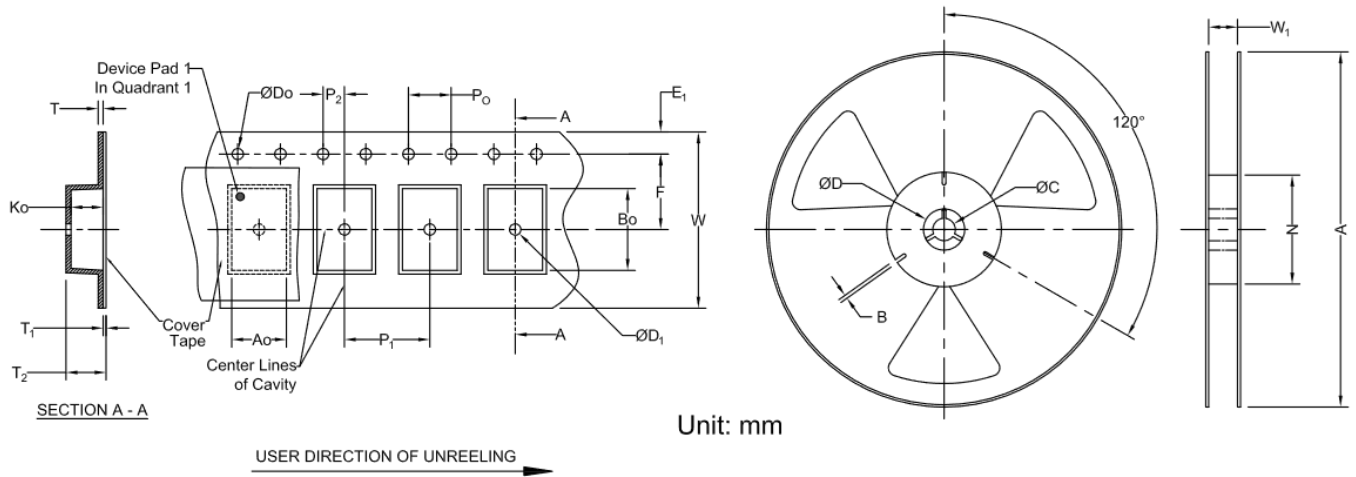

Carrier Tape Specifications (mm)

Do	K ₀	E ₁	P ₀	T	F	P ₁	W	A ₀	B ₀	Reel Qty
1.50 ± 0.1	0.6 max.	1.75 ± 0.1	4.0 ± 0.1	0.35 max.	3.5 ± 0.05	2.0 ± 0.1	8.0 ± 0.3	0.62 ± 0.05	1.12 ± 0.05	10,000

Reel Specifications (mm)

A	W ₁	N	B
178 ± 2.0	10.0 ± 1.5	58 ± 2.0	3.0 ± 0.1

ATTENTION: Abracon LLC's products are Commercial-Off-The-Shelf (COTS), which are designed, intended, and validated for use in commercial, industrial, and automotive applications. The customer is responsible for testing and verifying the performance of an Abracon solution to meet their system-level requirements.



5101 Hidden Creek Ln Spicewood TX 78669
 Phone: 512-371-6159 | Fax: 512-351-8858
 For terms and conditions of sales, please visit:
www.abracon.com

REVISION A: 12-20-24

ABRACON IS
 ISO9001-2015
 CERTIFIED