

PECL, LVDS

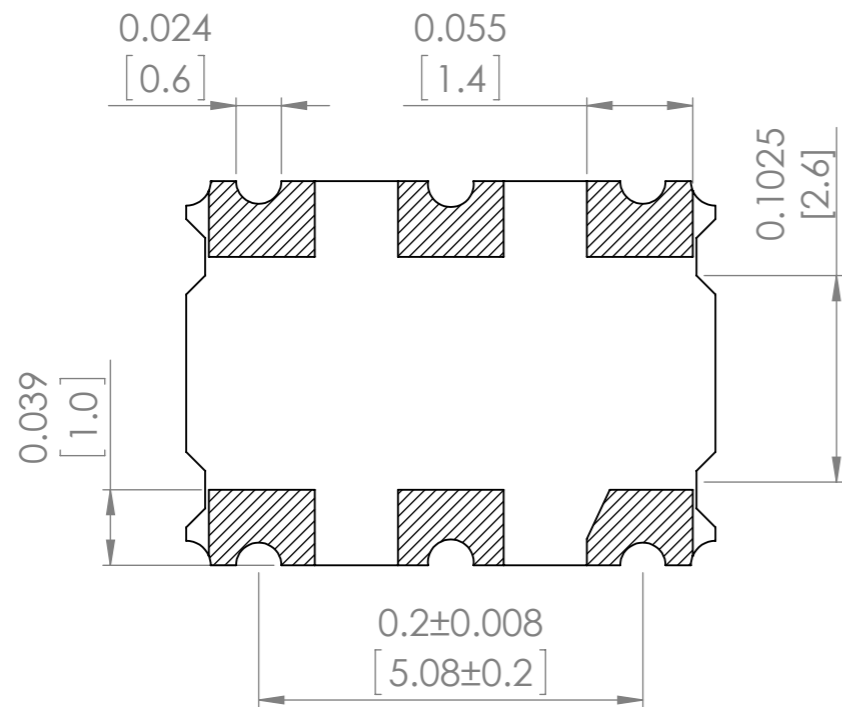

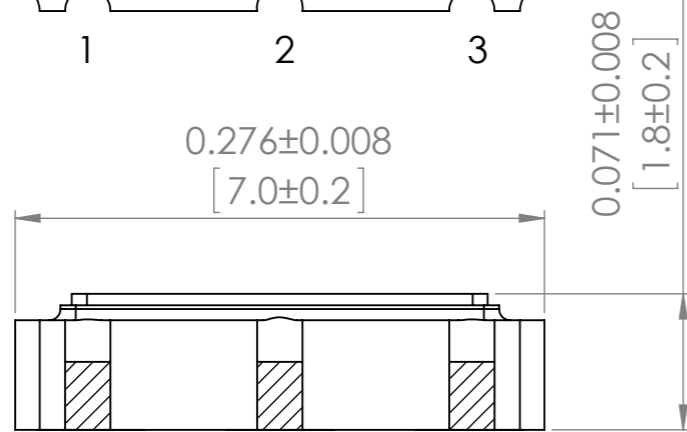

Bottom view

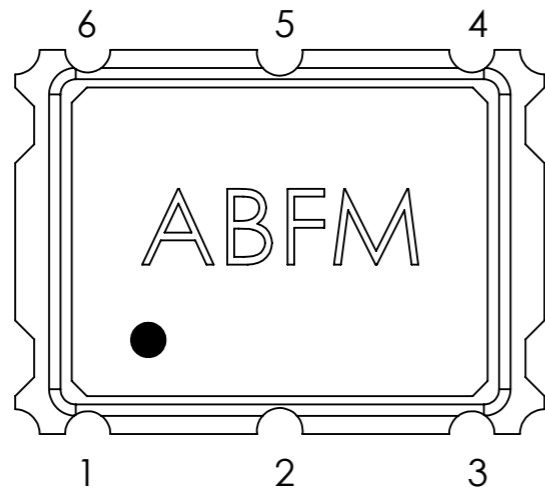
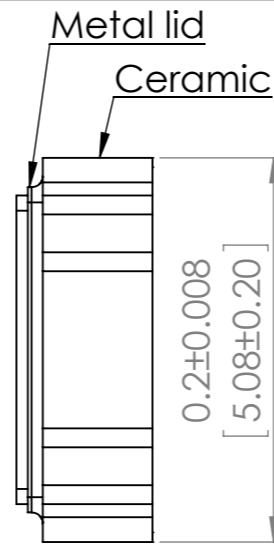

PIN #	Name	DESCRIPTION
1	Tri-state	Tristate
2	NC / Tristate	No Connect
3	GND	Ground
4	\bar{Q}	PECL, LVDS
5	Q	Complimentary PECL, LVDS
6	VDD	VDD Connection.

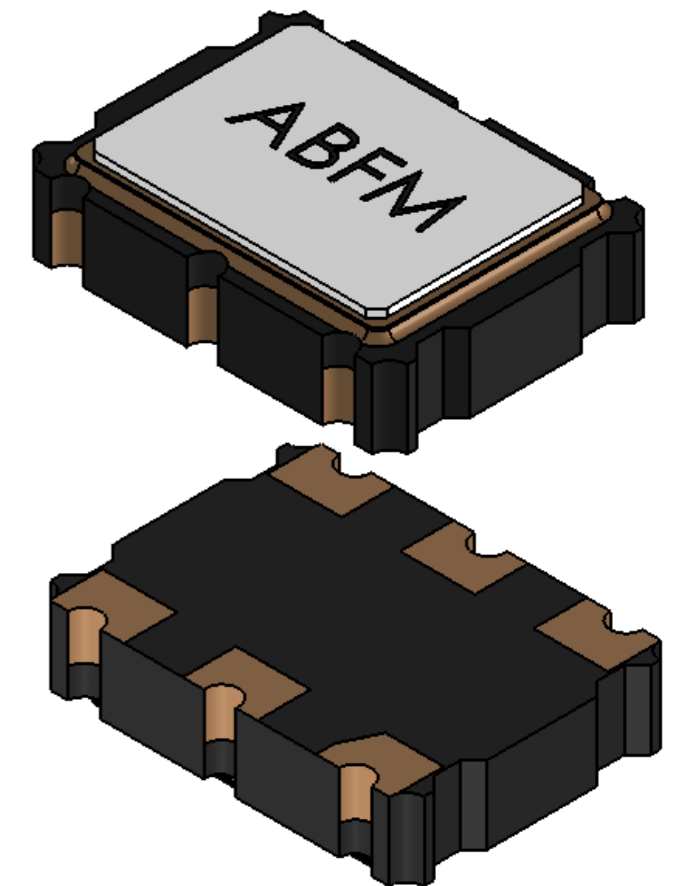
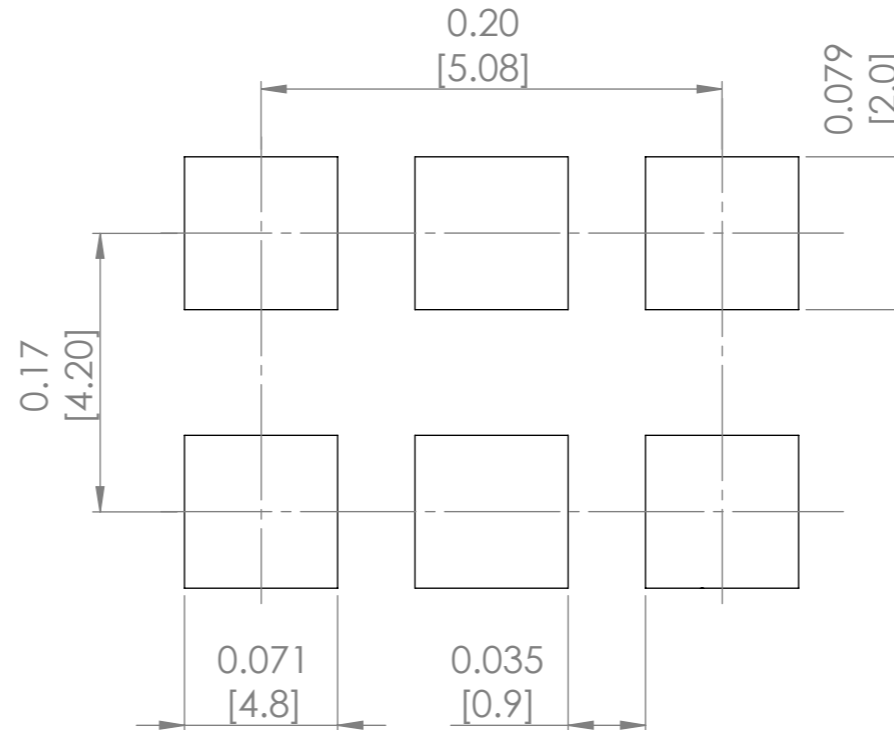
Recommended land Pattern



UNLESS OTHERWISE SPECIFIED: DIMENSIONS ARE IN MM SURFACE FINISH: TOLERANCES: LINEAR: ANGULAR:				FINISH:		DEBUR AND BREAK SHARP EDGES		DO NOT SCALE DRAWING		REVISION -	
DRAWN SAAZVAT				SIGNATURE		DATE		 <p>30332 Esperanza, Rancho Santa margarita, California 92688</p> <p>TITLE: Oscillator</p> <p>DWG NO. ABFM</p> <p>SCALE:4:1</p> <p>SHEET 1 OF 2</p>			
CHK'D XXXXXX											
APPV'D											
MFG											
Q.A											
				MATERIAL:				A3			
				WEIGHT:							

CMOS

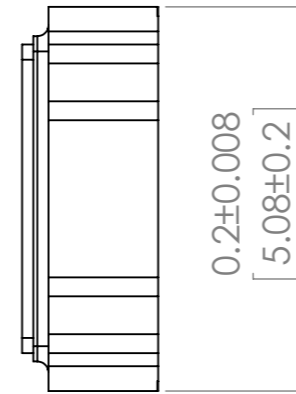
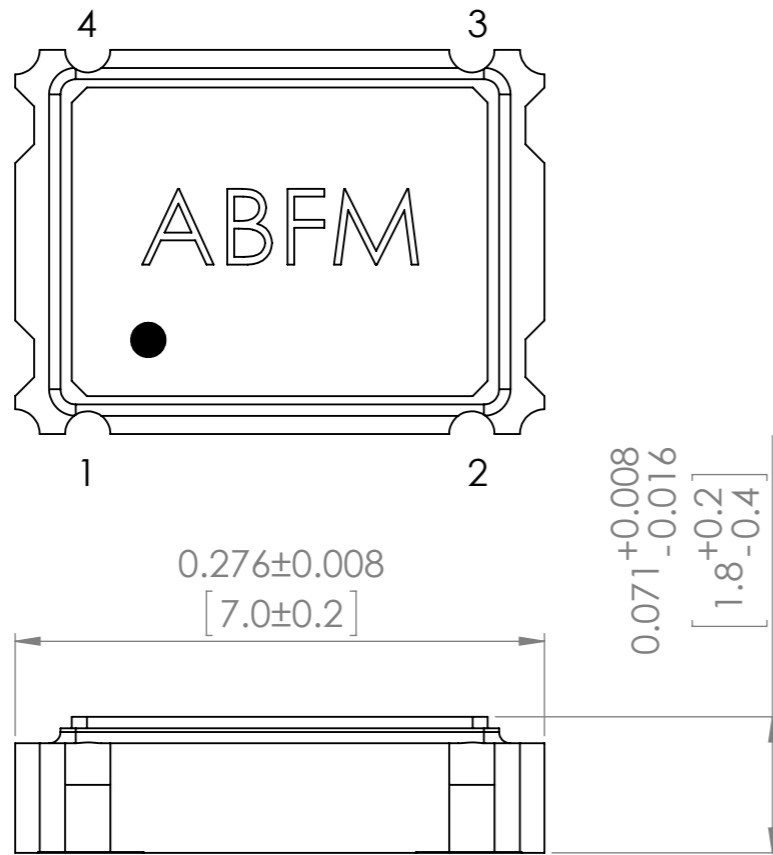

PIN #	Name
1	Tri-state
2	GND/Case
3	Output
4	Vdd

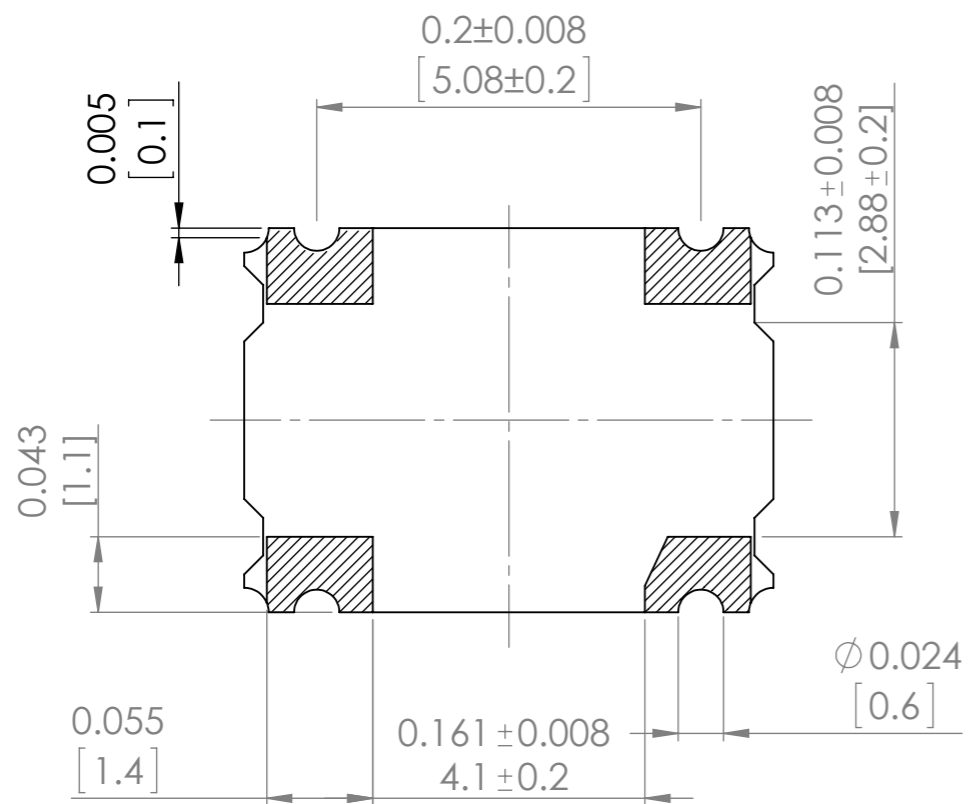
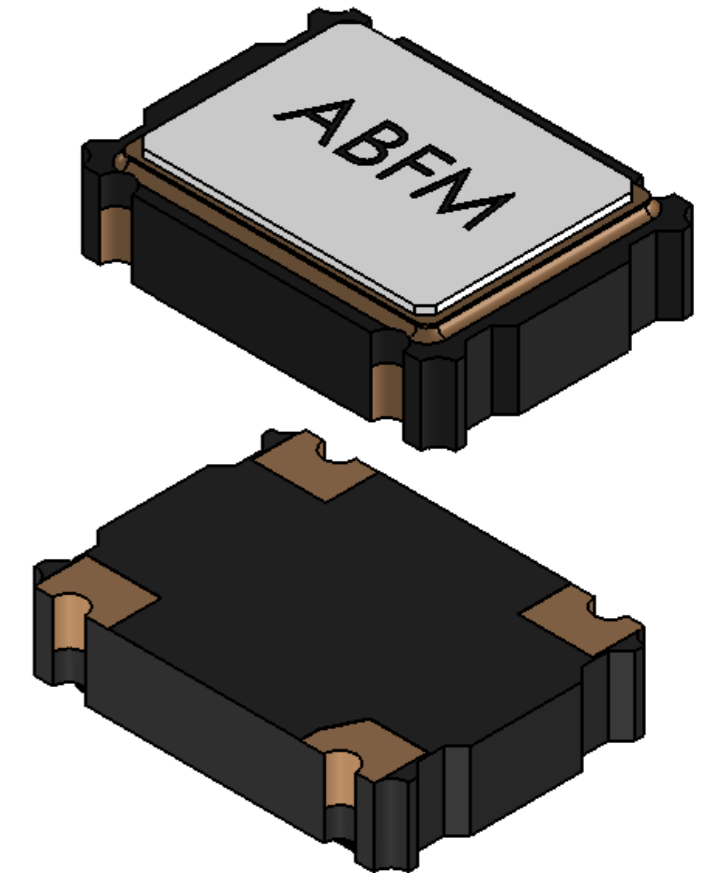

Bottom view

UNLESS OTHERWISE SPECIFIED: DIMENSIONS ARE IN MM SURFACE FINISH: TOLERANCES: LINEAR: ANGULAR:				FINISH:	DEBUR AND BREAK SHARP EDGES	DO NOT SCALE DRAWING	REVISION -
						 30332 Esperanza, Rancho Santa margarita, California 92688	
DRAWN	NAME	SIGNATURE	DATE			TITLE: Oscillator	
CHK'D	SAAZVAT					DWG NO. ABFM	
APPV'D	XXXXXX					SCALE: 4:1	
MFG				MATERIAL:		SHEET 2 OF 2	
Q.A				WEIGHT:		A3	