

MOUNTING HOLE

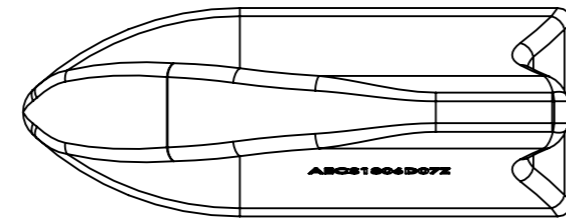

2.713±0.118
[68.90±3.00]

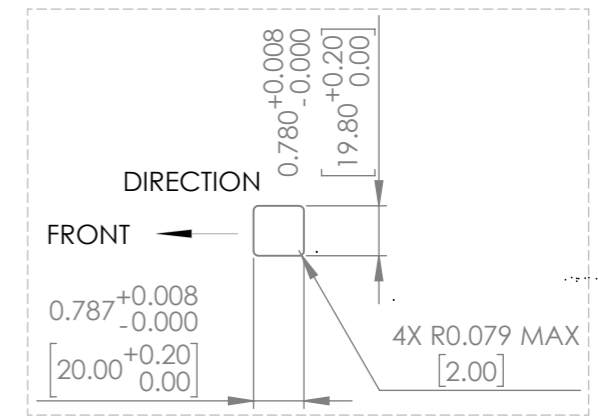
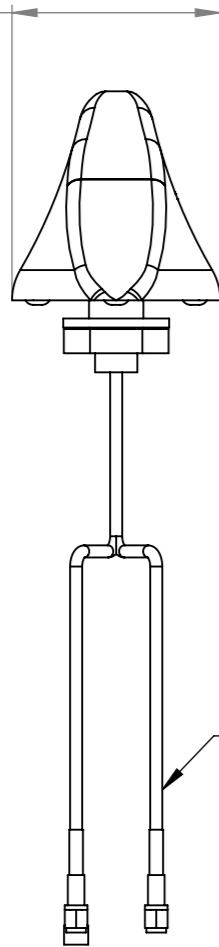

RG174

7.154±0.118
[181.70±3.00]

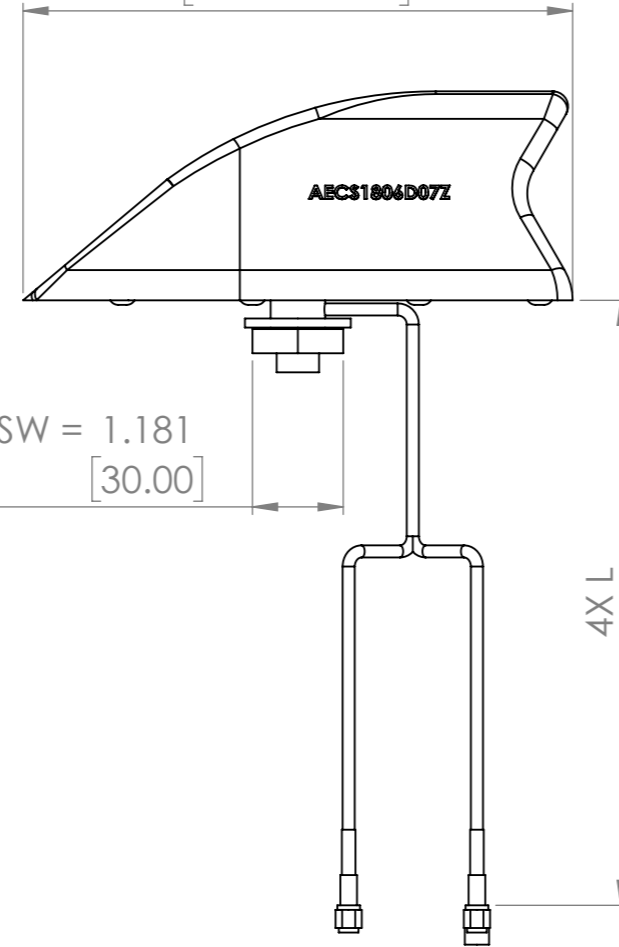

SW = 1.181
[30.00]

4X L

L = 200 ± 10mm

2.720±0.118
[69.10±3.00]

0.937
[23.80]
REF

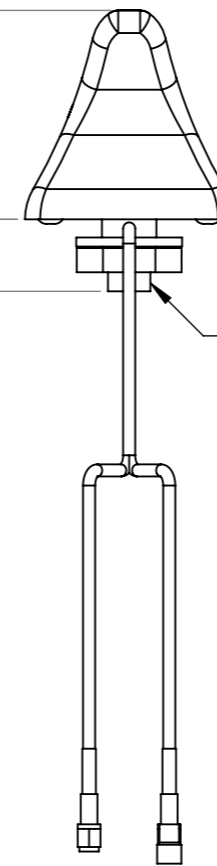

M14 X0.75

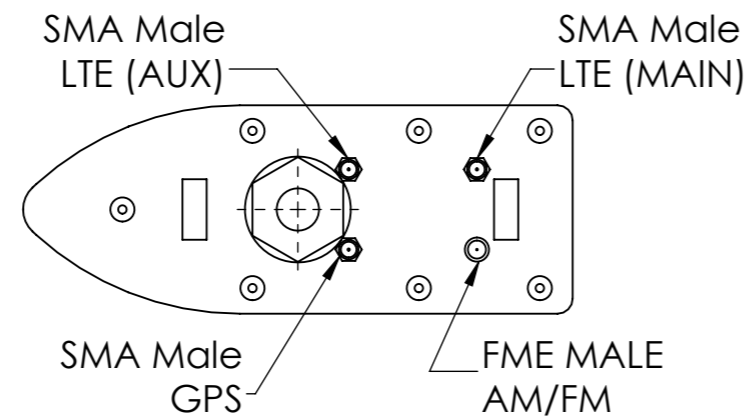
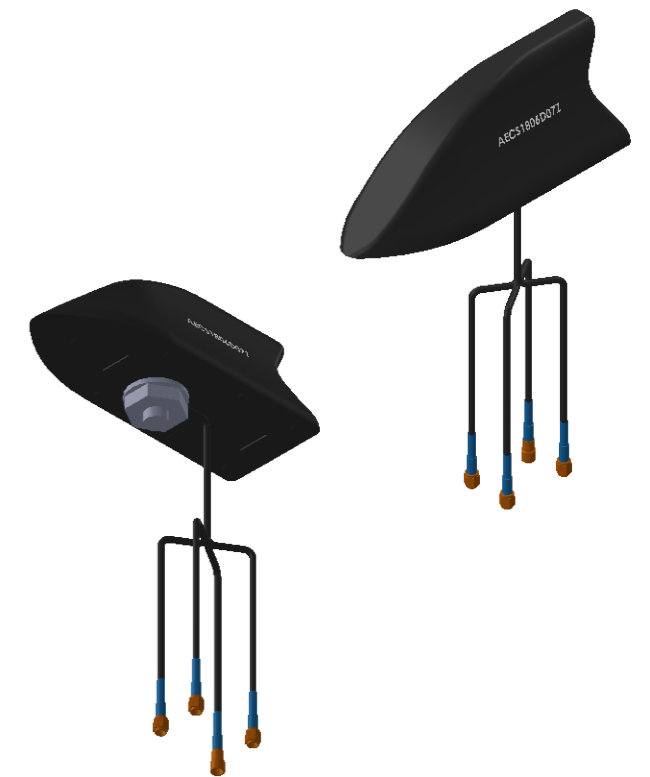

DIMENSIONS: INCHES[MM]

TOP PACKAGE MARKING IS FOR ILLUSTRATION PURPOSES ONLY

DO NOT SCALE DRAWING		REVISION	-
5101 Hidden Creek Lane, Spicewood Texas-78669			
TITLE: AUTOMOTIVE GRADE MIMO LTE +GNSS+AM/FM EXTERNAL COM			
DWG NO.		AEC51806D07Z	A3
SCALE: 1:2.5		SHEET 1 OF 1	