

INDUSTRIAL GRADE BUILT-IN CAPACITANCE CERAMIC RESONATOR

AWSCR



3.7 x 3.1 x 1.2 mm

AWSCR-MV

Pb in ceramic
(exempt per RoHS 2002/95/EC Annex (7))

RoHS
Compliant

FEATURES:

- Low resonant impedance
- High stability type
- Excellent environmental resistance
- Reflow capable
- Industrial grade
- Built-in load capacitance

APPLICATIONS:

- Remote controls, Microprocessor clocks, Mobile phones, DVD & CD-Roms, Electric appliances, Industrial controllers

ELECTRICAL CHARACTERISTICS:

Item	Requirement
Frequency Range	8.00MHz to 50.00 MHz
Resonant Impedance	40Ω max.
Frequency Tolerance and stability	See Table 2.1
Withstanding Voltage	50 (DC , 1 min)
Rating Voltage	
(1) D.C.Voltage	10 V.D.C. max
(2) A.C. Voltage	15 Vp-p. max
Load Capacitance	see Table 2.2 for standard see Option Code for options
Insulation Resistance	500MΩ min. (10V, 1min)
Operating Temperature	See Table 2.1
Storage Temperature	-40°C to +125°C
Aging Rate (Fosc)	±0.3% max. (10 years)

TABLE 2.1

Part Number (XX.XX denotes freq. in MHz)	Frequency Tolerance at 25°C	Frequency Stability at Operating Temp.	Operating Temperature	Resonant Impedance (Ω) max
AWSCR-XX.XXMVS 8.00 MHz - 13.00 MHz 13.01 MHz - 50.00 MHz	±0.3%	± 0.3%	-20° to +80°C	30 40
AWSCR-XX.XXMVD 8.00 MHz - 13.00 MHz 13.01 MHz - 50.00 MHz	±0.3%	± 0.5%	-40° to +85°C	30 40
AWSCR-XX.XXMVA 8.00 MHz - 13.00 MHz 13.01 MHz - 50.00 MHz	±0.3%	± 0.7%	-40° to +125°C	30 40

TABLE 2.2

Freq (MHz)	Cl=C2 pf (±20%)
8.00~13.00	20
13.01~16.00	20
16.01~40.00	10
40.01~50.00	5

TEST CIRCUIT:

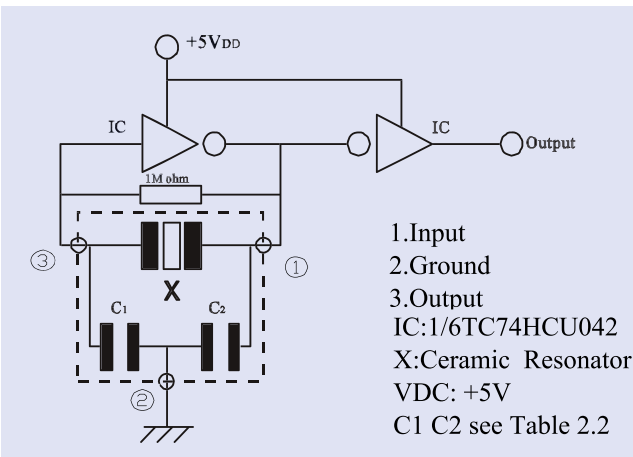

OPTIONS & PART IDENTIFICATION:

(Left blank if standard)

AWSCR - Frequency- MV□ - C□□ - □

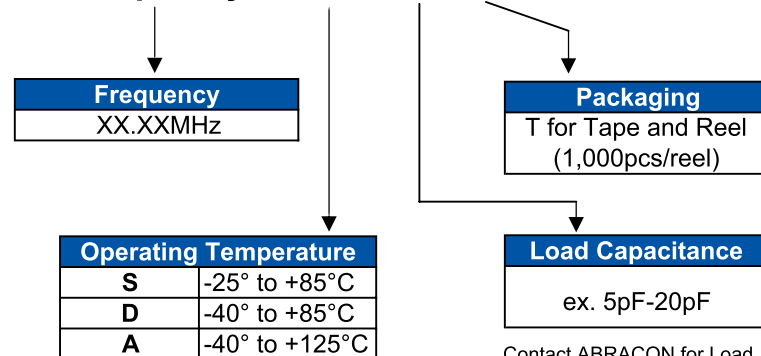

Contact ABRACON for Load Capacitance options

INDUSTRIAL GRADE BUILT-IN CAPACITANCE CERAMIC RESONATOR

AWSCR



3.7 x 3.1 x 1.2 mm

AWSCR-MV

Pb in ceramic
(exempt per RoHS 2002/95/EC Annex (7))

RoHS
Compliant

➤ OUTLINE DRAWING:

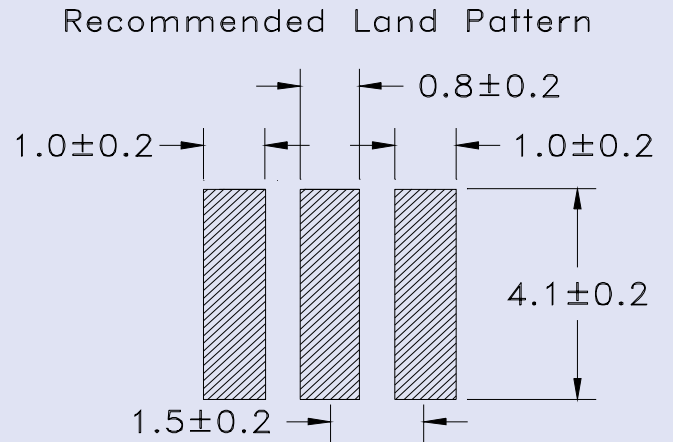
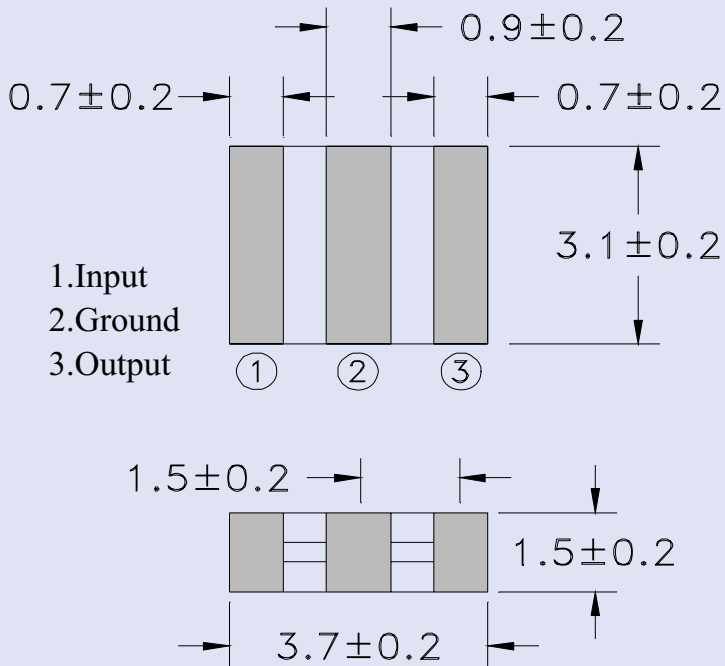

Dimensions: mm

➤ TAPE & REEL: T = Tape and reel 1,000pcs/reel

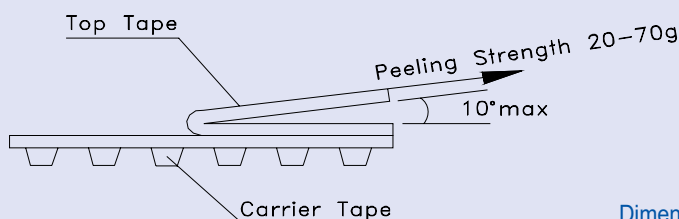
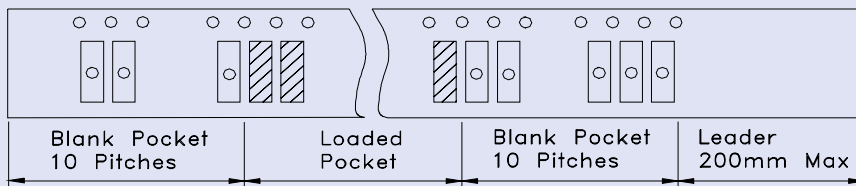
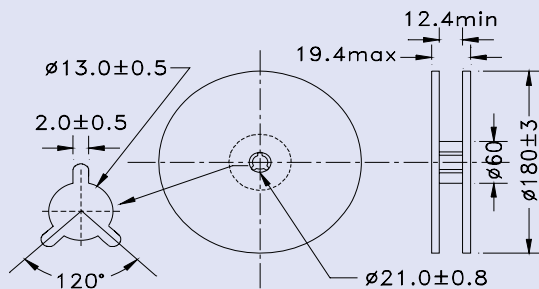

Dimensions: mm

ABRACON IS
ISO 9001 / QS 9000
CERTIFIED



ABRACON
CORPORATION

Visit www.abracon.com for Terms & Conditions of Sale **Revised: 08.20.07**

30332 Esperanza, Rancho Santa Margarita, California 92688

tel 949-546-8000 | fax 949-546-8001 | www.abracon.com

INDUSTRIAL GRADE BUILT-IN CAPACITANCE CERAMIC RESONATOR

AWSCR



3.7 x 3.1 x 1.2 mm

AWSCR-MV

Pb in ceramic
(exempt per RoHS 2002/95/EC Annex (7))

RoHS
Compliant

SUGGESTED REFLOW PROFILE:

ROHS reflow profile high temperature
(applies to parts manufactured after 2/1/2007 -lot# later than 07 01 xxx)

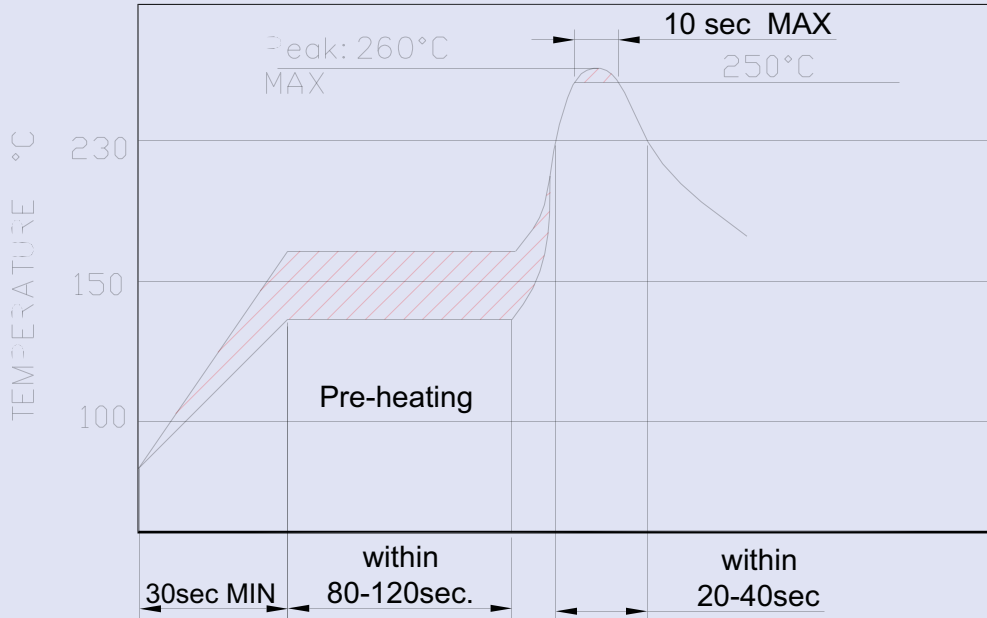

ROHS reflow profile
(applies to parts manufactured before 2/1/2007 -lot# before than 07 01 xxx)

