

# Molded SMD Power Inductor



## ASPIAIG-F70xx Series

Request Samples



Check Inventory



7.8 x 7.6 x 1.85 mm

7.8 x 7.6 x 2.90 mm

RoHS/RoHS II Compliant

MSL Level = 1

### Features

- PPAP ready and supported
- TS16949 certified production lines
- AEC-Q200 qualified
- Excellent current capacity – up to 32A
- Exceptionally low DCR – only 3.2mΩ
- Soft saturation
- Low profile for compact designs
- Shielded constructions for low EMI

### Applications

- Automotive grade 0 and electric vehicles
- ADAS and body electronics
- Infotainment systems
- Lighting
- Motor control
- Solar inverters and solar power
- DC/DC converters in distributed power systems
- Battery powered device

### Electrical Specifications

Part Number	Inductance	Tolerance	DC Resistance	Saturation Current	Temperature Rise Current	D
	0.1MHz/0.1V		Max	Max	Max	
Units	μH	%	mΩ	A	A	mm
Symbol	L	M	DCR	Isat	Irms	mm
ASPIAIG-F7020-R27	0.27	20%	3.5	32.0	21.0	6.6
ASPIAIG-F7020-R31	0.31	20%	4.8	31.0	20.0	6.2
ASPIAIG-F7020-R33	0.33	20%	4.8	31.0	19.0	6.2
ASPIAIG-F7020-R47	0.47	20%	6.2	25.0	17.0	6.2
ASPIAIG-F7020-R68	0.68	20%	9.2	23.0	13.0	6.2
ASPIAIG-F7020-1R0	1.00	20%	10.8	20.0	11.0	6.2
ASPIAIG-F7030-R60	0.60	20%	3.2	32.0	23.0	6.6
ASPIAIG-F7030-1R0	1.00	20%	5.0	28.0	21.8	6.6
ASPIAIG-F7030-1R5	1.50	20%	8.25	23.5	15.3	6.6
ASPIAIG-F7030-2R2	2.20	20%	13.7	17.0	13.0	6.2
ASPIAIG-F7030-3R3	3.30	20%	18.0	13.0	10.0	6.2
ASPIAIG-F7030-4R7	4.70	20%	26.7	12.2	9.0	6.2
ASPIAIG-F7030-5R6	5.60	20%	33.2	11.5	7.3	6.2
ASPIAIG-F7030-6R8	6.80	20%	42.5	11.0	6.8	6.2
ASPIAIG-F7030-8R2	8.20	20%	48.73	9.0	5.9	6.2

### Test Conditions

**Isat:** Current at which the inductance drops 30% from its initial value

**Irms:** Current at which the temperature rises ( $\Delta T$ , approximate 40 °C) from 20°C ambient

**Operating Temperature:** -55°C ~ +155°C (including self-temperature rise)

**Storage Condition:** -10°C ~ +40°C and R.H. 60% max

**Operating Voltage:** 40V

ASPIAIG-F7020/F7030 Series is **RoHS Compliant and Pb free**

ASPIAIG-F7020/F7030 Series is **AEC-Q200 Grade 0 qualified (-55°C ~ +155°C ambient)**

MSL level: 1



5101 Hidden Creek Ln Spicewood TX 78669  
Phone: 512-371-6159 | Fax: 512-351-8858  
For terms and conditions of sales, please visit:  
www.abracon.com

REVISION B : 11/10/2021

ABRACON IS  
ISO9001-2015  
CERTIFIED

# Molded SMD Power Inductor



## ASPIAIG-F70xx Series

Request Samples



Check Inventory



7.8 x 7.6 x 1.85 mm  
 7.8 x 7.6 x 2.90 mm  
 RoHS/RoHS II Compliant  
 MSL Level = 1

ASPIAIG-F7020-R27

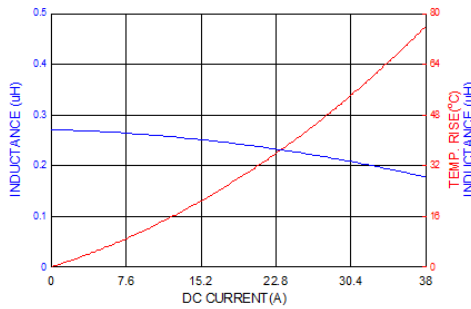

ASPIAIG-F7020-R31

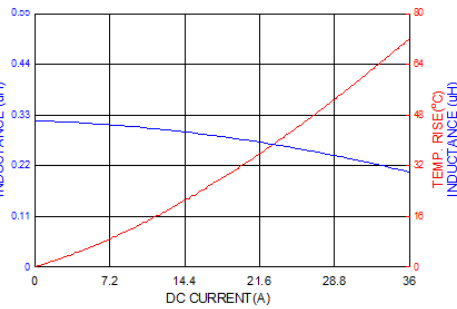

ASPIAIG-F7020-R33

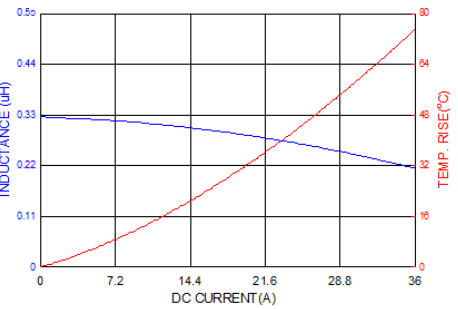

ASPIAIG-F7020-R47

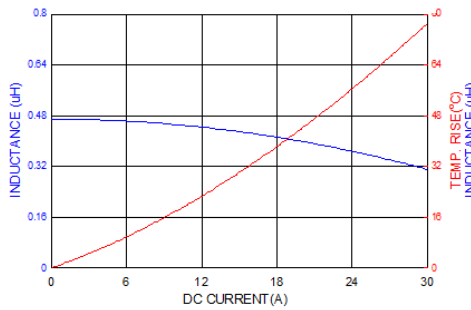

ASPIAIG-F7020-R68

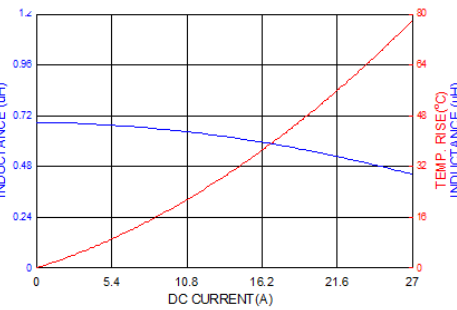

ASPIAIG-F7020-1R0

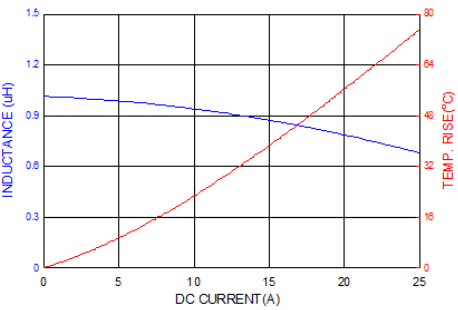

ASPIAIG-F7030-R60

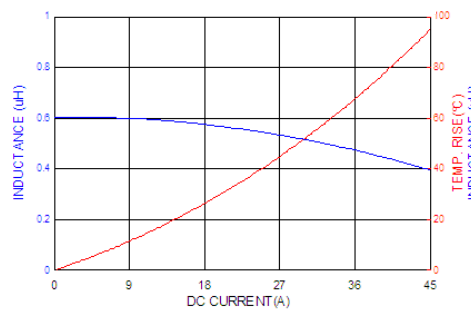

ASPIAIG-F7030-1R0

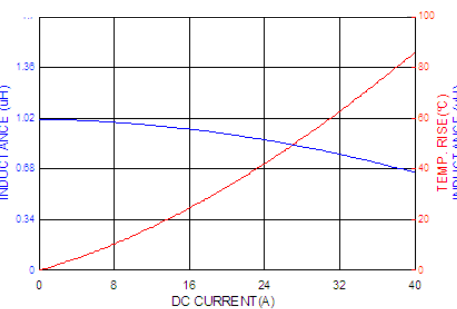

ASPIAIG-F7030-1R5

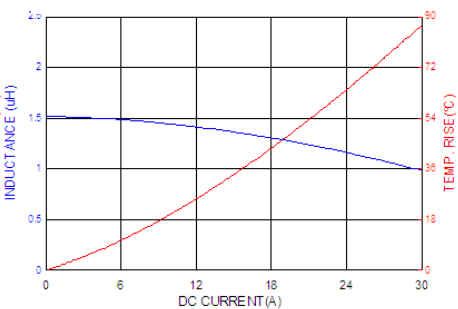

5101 Hidden Creek Ln Spicewood TX 78669  
 Phone: 512-371-6159 | Fax: 512-351-8858  
 For terms and conditions of sales, please visit:  
[www.abracon.com](http://www.abracon.com)

REVISION B : 11/10/2021

ABRACON IS  
 ISO9001-2015  
 CERTIFIED

# Molded SMD Power Inductor



## ASPIAIG-F70xx Series

Request Samples



Check Inventory



7.8 x 7.6 x 1.85 mm  
 7.8 x 7.6 x 2.90 mm  
 RoHS/RoHS II Compliant  
 MSL Level = 1

ASPIAIG-F7030-2R2

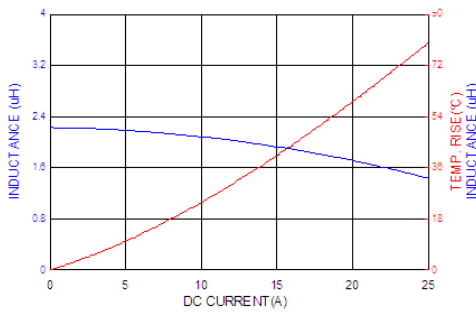

ASPIAIG-F7030-3R3

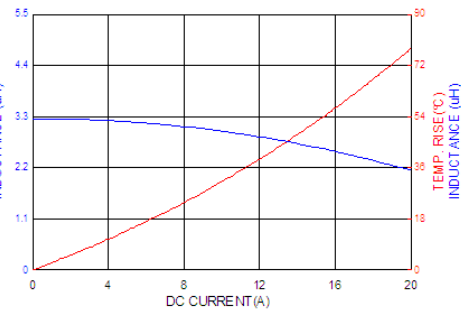

ASPIAIG-F7030-4R7

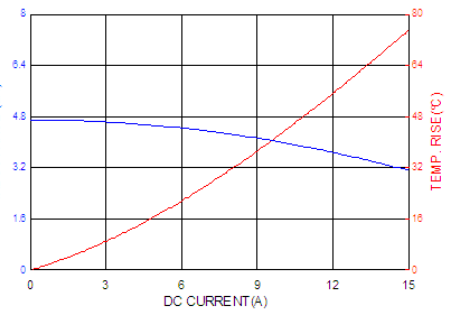

ASPIAIG-F7030-5R6

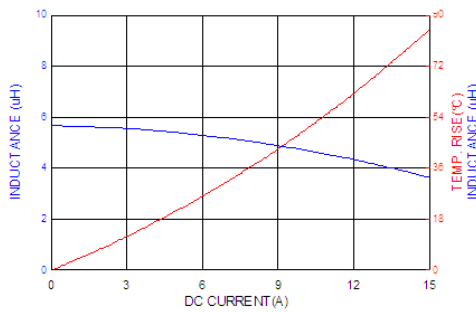

ASPIAIG-F7030-6R8

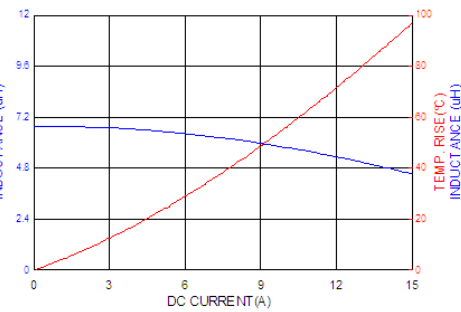

ASPIAIG-F7030-8R2

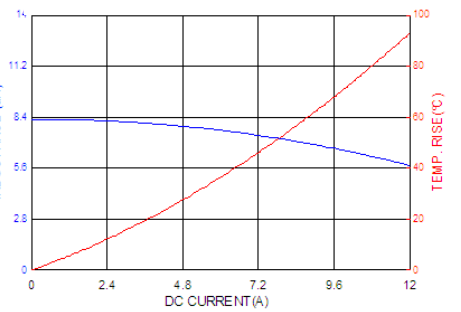

5101 Hidden Creek Ln Spicewood TX 78669  
 Phone: 512-371-6159 | Fax: 512-351-8858  
 For terms and conditions of sales, please visit:  
[www.abracon.com](http://www.abracon.com)

REVISION B : 11/10/2021

ABRACON IS  
 ISO9001-2015  
 CERTIFIED

# Molded SMD Power Inductor



ASPIAIG-F70xx Series

Request Samples



Check Inventory



7.8 x 7.6 x 1.85 mm  
 7.8 x 7.6 x 2.90 mm  
 RoHS/RoHS II Compliant  
 MSL Level = 1

## Mechanical Specifications

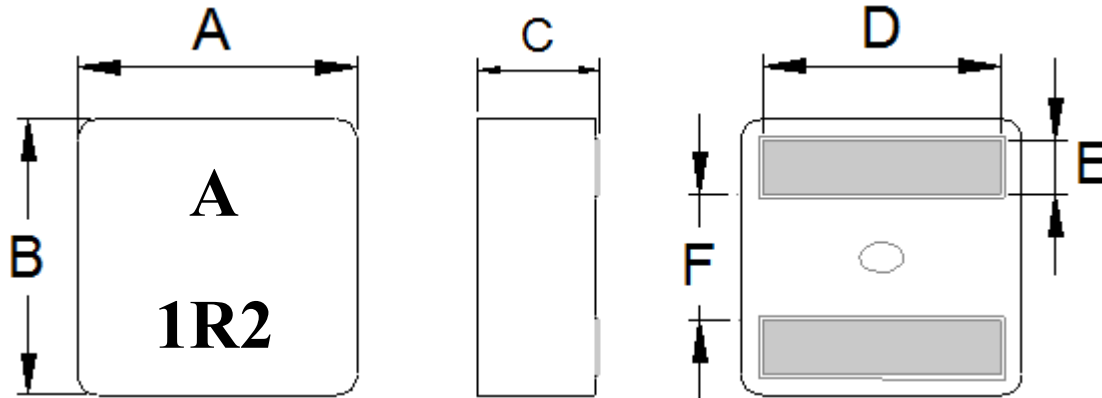

Series	A	B	C	D	E	F
ASPIAIG-F7020	7.8 ± 0.25	7.6 ± 0.2	1.85 ± 0.2	See Spec Table	1.75 ± 0.2	3.15 ± 0.25
ASPIAIG-F7030	7.8 ± 0.25	7.6 ± 0.2	2.90 ± 0.2	See Spec Table	1.75 ± 0.2	3.15 ± 0.25

## Recommended Land Pattern

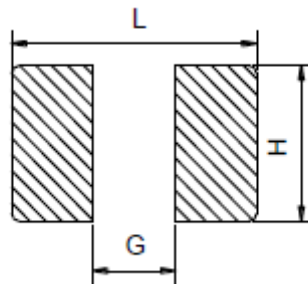

L Typ.	G Typ.	H Typ.
7.4	2.8	7.2

Dimension: mm



5101 Hidden Creek Ln Spicewood TX 78669  
 Phone: 512-371-6159 | Fax: 512-351-8858  
 For terms and conditions of sales, please visit:  
[www.abracon.com](http://www.abracon.com)

REVISION B : 11/10/2021

ABRACON IS  
 ISO9001-2015  
 CERTIFIED

# Molded SMD Power Inductor



ASPIAIG-F70xx Series

Request Samples



Check Inventory



7.8 x 7.6 x 1.85 mm  
 7.8 x 7.6 x 2.90 mm  
**RoHS/RoHS II Compliant**  
 MSL Level = 1

## Part Identification

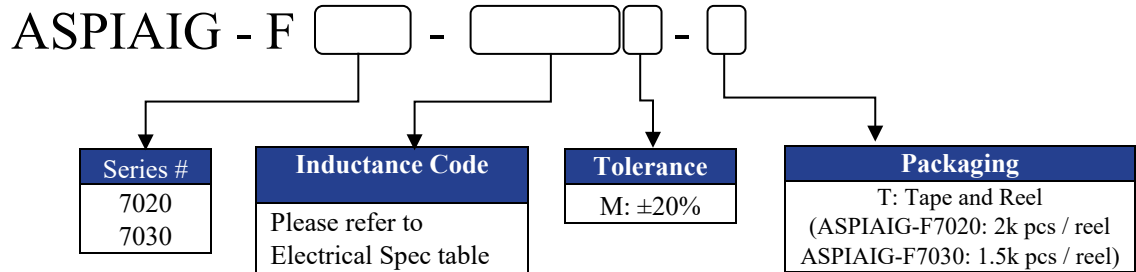

## Marking

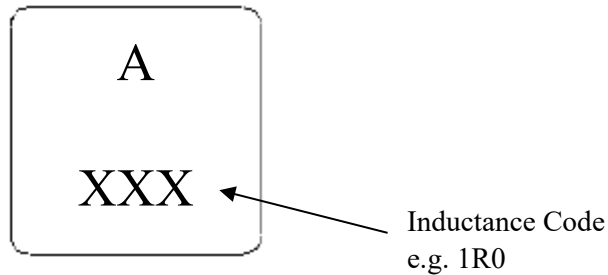

## Materials

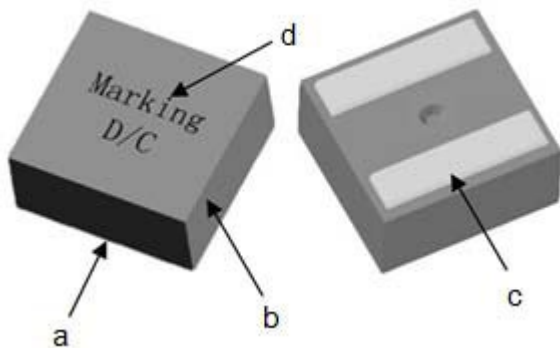

	Components	Material
a	Core	Alloy powder
b	Wire	220 deg. C Flat Wire
c	Solder	100% Pb free solder
d	Ink	Halogen-free ketone

# Molded SMD Power Inductor



ASPIAIG-F70xx Series

Request Samples



Check Inventory



7.8 x 7.6 x 1.85 mm  
 7.8 x 7.6 x 2.90 mm  
 RoHS/RoHS II Compliant  
 MSL Level = 1

## Reflow Profile

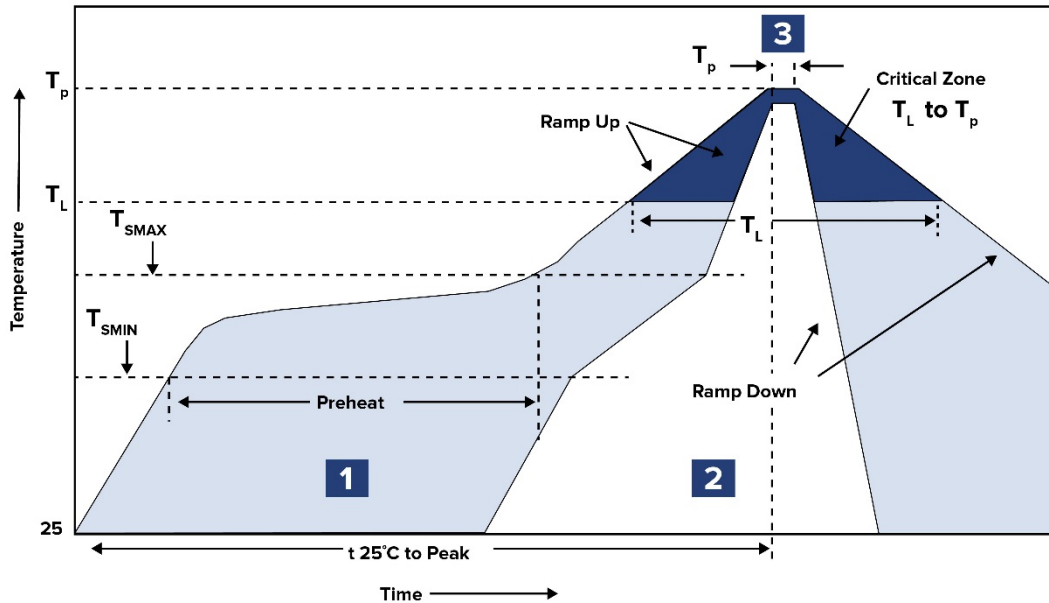

Zone	Description	Temperature	Times
1	Preheat	$T_{SMIN} \sim T_{SMAX}$ 150°C ~ 200°C	60 ~ 180 sec.
2	Reflow	$T_L$ 217°C	60 ~ 150 sec.
3	Peak heat	$T_P$ 260°C±5°C	10 sec. MAX

# Molded SMD Power Inductor



**ASPIAIG-F70xx Series**

Request Samples



Check Inventory



7.8 x 7.6 x 1.85 mm  
 7.8 x 7.6 x 2.90 mm  
**RoHS/RoHS II Compliant**  
 MSL Level = 1

## Packaging (Tape & Reel)

**ASPIAIG-F7020: 2000pcs / reel**

**ASPIAIG-F7030: 1500pcs / reel**

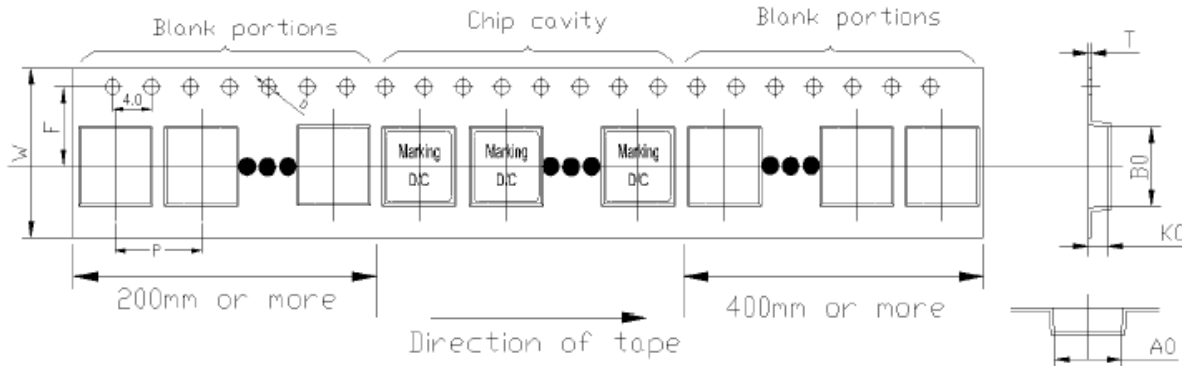

Series	W	F	P	D	A <sub>0</sub>	B <sub>0</sub>	T	K <sub>0</sub>
ASPIAIG-F7020	16.0±0.3	7.5±0.1	12.0±0.1	1.5±0.1	8.2±0.1	8.0±0.1	0.35±0.1	2.3±0.1
ASPIAIG-F7030	16.0±0.3	7.5±0.1	12.0±0.1	1.5±0.1	8.2±0.1	8.0±0.1	0.35±0.1	3.3±0.1

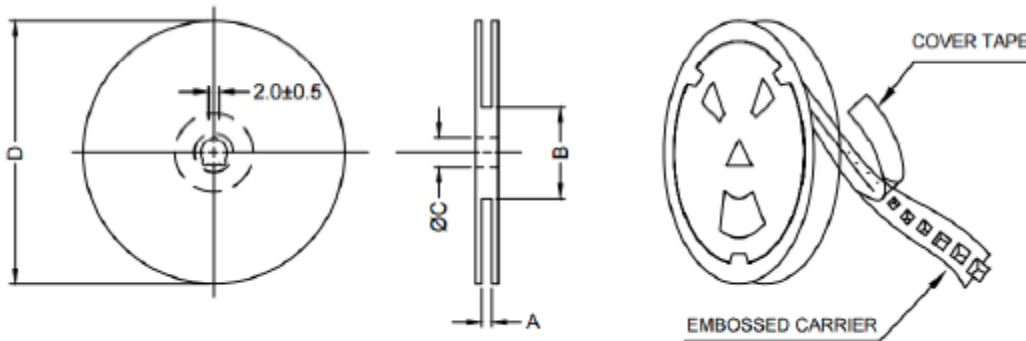

A	B	C	D
16.4+2/-0	100 ± 2	13.0+0.5/-0.2	330

**Dimension: mm**

**ATTENTION:** Abracon LLC's products are COTS – Commercial-Off-The-Shelf products; suitable for Commercial, Industrial and, where designated, Automotive Applications. Abracon's products are not specifically designed for Military, Aviation, Aerospace, Life-dependent Medical applications or any application requiring high reliability where component failure could result in loss of life and/or property. For applications requiring high reliability and/or presenting an extreme operating environment, written consent and authorization from Abracon LLC is required. Please contact Abracon LLC for more information.



5101 Hidden Creek Ln Spicewood TX 78669  
 Phone: 512-371-6159 | Fax: 512-351-8858  
 For terms and conditions of sales, please visit:  
[www.abracon.com](http://www.abracon.com)

**REVISION B : 11/10/2021**

ABRACON IS  
 ISO9001-2015  
 CERTIFIED