

# Molded SMD Power Inductor



## ASPIAIG-F5030 Series

Request Samples



Check Inventory



5.5 x 5.3 x 2.9 mm

RoHS/RoHS II Compliant

MSL Level = 1

### Features

- PPAP ready and supported
- TS16949 certified production lines
- AEC-Q200 qualified
- Excellent current capacity – up to 32.5A
- Exceptionally low DCR – only 2.3mΩ
- Soft saturation
- Low profile for compact designs
- Shielded constructions for low EMI

### Applications

- Automotive grade 0 and electric vehicles
- ADAS and body electronics
- Infotainment systems
- Lighting
- Motor control
- Solar inverters and solar power
- DC/DC converters in distributed power systems
- Battery powered device

### Electrical Specifications

Part Number	Inductance	Tolerance	DC Resistance	Saturation Current	Temperature Rise Current
	0.1MHz/0.1V		Max	Max	Max
Units	μH	%	mΩ	A	A
Symbol	L	M	DCR	Isat	Irms
ASPIAIG-F5030-R15	0.15	20%	2.31	32.5	22.2
ASPIAIG-F5030-R16	0.16	20%	2.33	32.0	22.2
ASPIAIG-F5030-R28	0.28	20%	3.30	28.0	19.0
ASPIAIG-F5030-R33	0.33	20%	3.52	26.0	19.2
ASPIAIG-F5030-R47	0.47	20%	4.13	24.0	18.4
ASPIAIG-F5030-R56	0.56	20%	4.52	20.2	17.7
ASPIAIG-F5030-R60	0.60	20%	4.52	20.0	17.7
ASPIAIG-F5030-R80	0.80	20%	5.65	18.0	13.1
ASPIAIG-F5030-R82	0.82	20%	5.78	17.6	12.9
ASPIAIG-F5030-1R0	1.00	20%	7.60	14.3	12.2
ASPIAIG-F5030-1R2	1.20	20%	9.70	13.5	11.0
ASPIAIG-F5030-1R5	1.50	20%	11.2	12.5	10.5
ASPIAIG-F5030-1R8	1.80	20%	12.7	11.3	10.1
ASPIAIG-F5030-2R2	2.20	20%	14.5	9.0	9.70
ASPIAIG-F5030-3R3	3.30	20%	23.1	8.7	8.10
ASPIAIG-F5030-4R7	4.70	20%	36.3	7.0	5.90

### Test Conditions

**Isat:** Current at which the inductance drops 30% from its initial value

**Irms:** Current at which the temperature rises ( $\Delta T$ , approximate 40 °C) from 20°C ambient

**Operating Temperature:** -55°C ~ +155°C (including self-temperature rise)

**Storage Condition:** -55°C ~ +155°C and R.H. 60% max (on PCB)

ASPIAIG-F5030 Series is **RoHS Compliant and Pb free**

ASPIAIG-F5030 Series is **AEC-Q200 Grade 0 qualified (-55°C ~ +155°C ambient)**

**Operating Voltage:** 40V

**MSL level:** 1



5101 Hidden Creek Ln Spicewood TX 78669  
Phone: 512-371-6159 | Fax: 512-351-8858  
For terms and conditions of sales, please visit:  
[www.abracon.com](http://www.abracon.com)

REVISION A : 11/10/2021

ABRACON IS  
ISO9001-2015  
CERTIFIED

# Molded SMD Power Inductor



## ASPIAIG-F5030 Series

Request Samples



Check Inventory



5.5 x 5.3 x 2.9 mm  
RoHS/RoHS II Compliant  
MSL Level = 1

ASPIAIG-F5030-R15

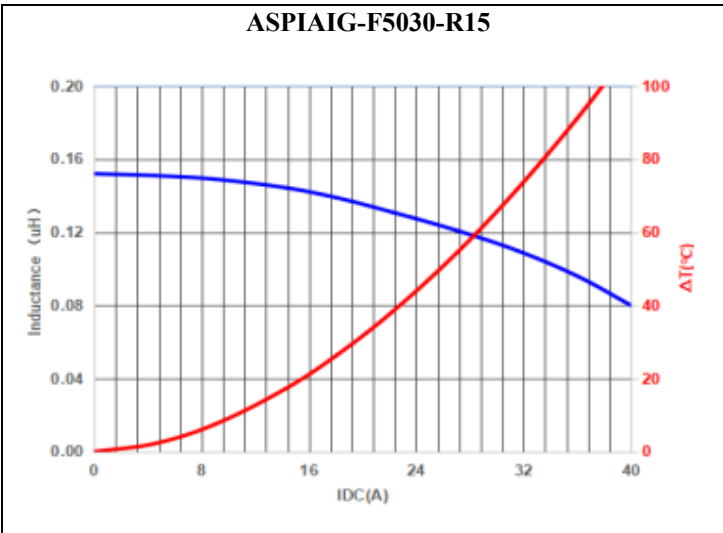

ASPIAIG-F5030-R16

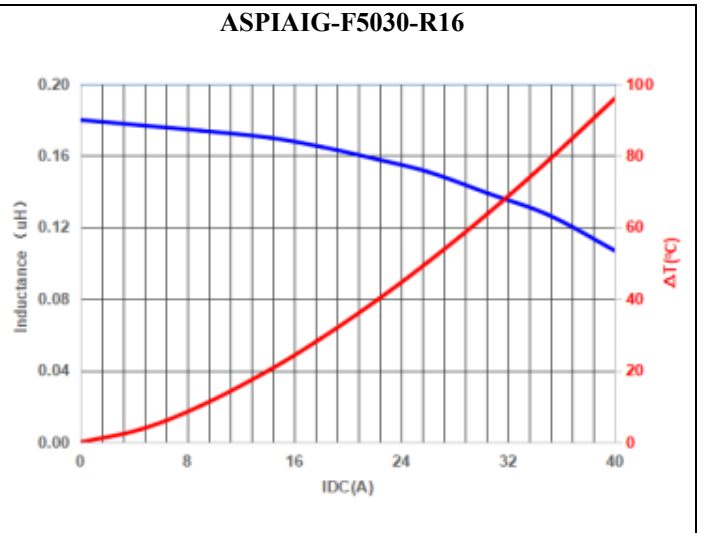

ASPIAIG-F5030-R28

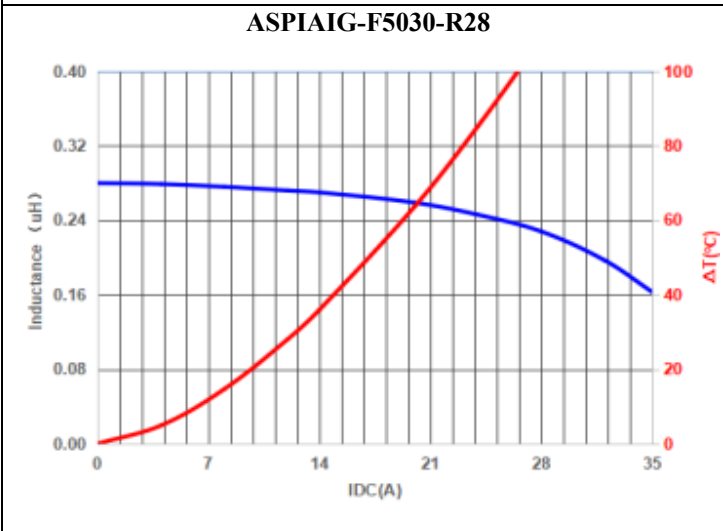

ASPIAIG-F5030-R33

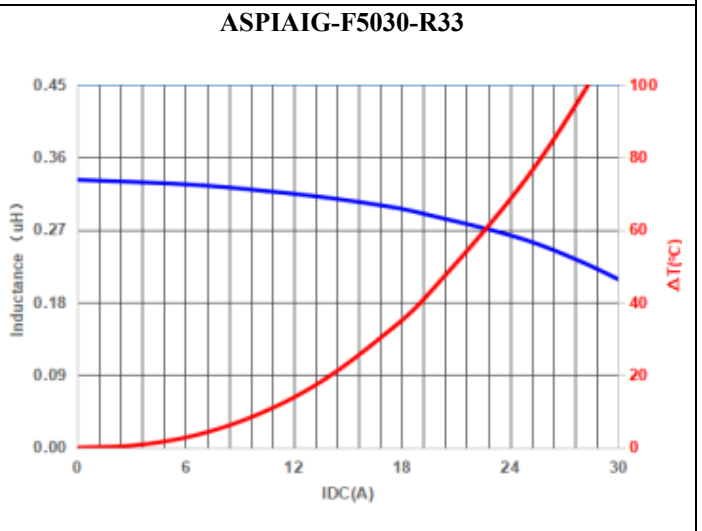

ASPIAIG-F5030-R47

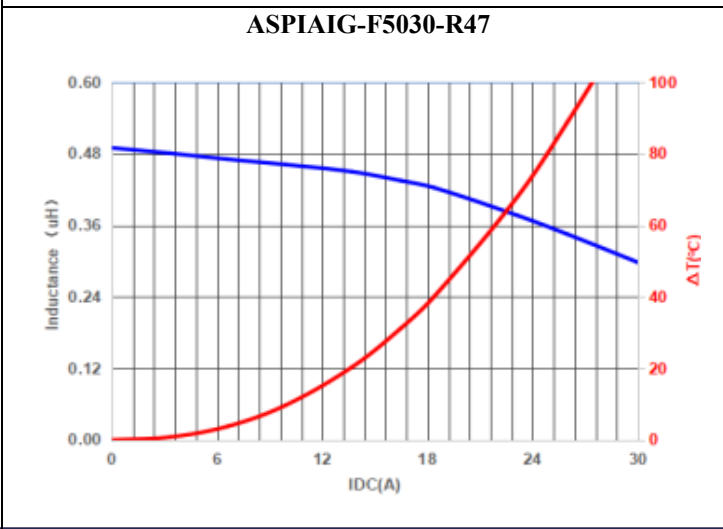

ASPIAIG-F5030-R56

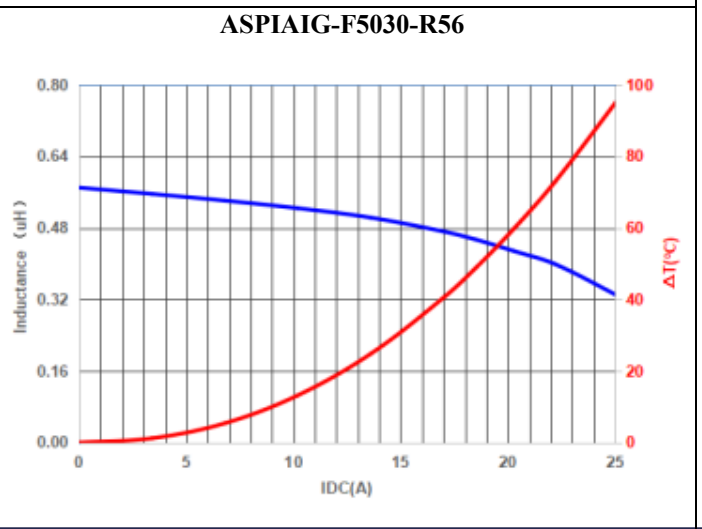

5101 Hidden Creek Ln Spicewood TX 78669  
Phone: 512-371-6159 | Fax: 512-351-8858  
For terms and conditions of sales, please visit:  
[www.abracon.com](http://www.abracon.com)

REVISION A : 11/10/2021

ABRACON IS  
ISO9001-2015  
CERTIFIED

# Molded SMD Power Inductor



## ASPIAIG-F5030 Series

Request Samples



Check Inventory



5.5 x 5.3 x 2.9 mm  
 RoHS/RoHS II Compliant  
 MSL Level = 1

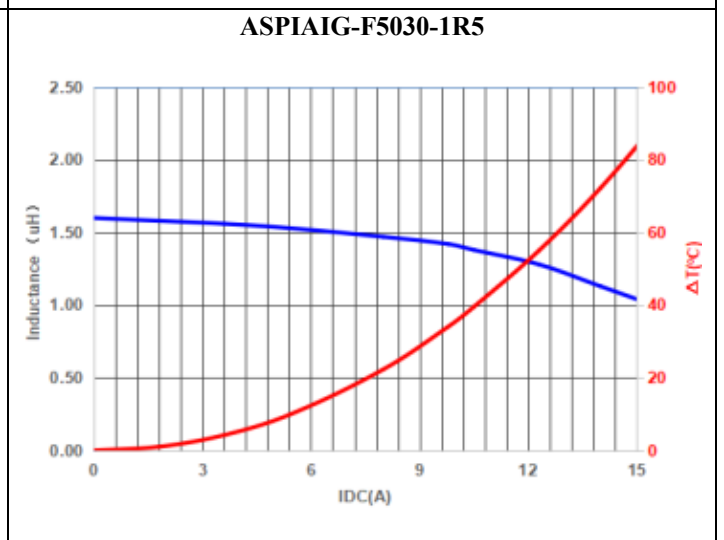
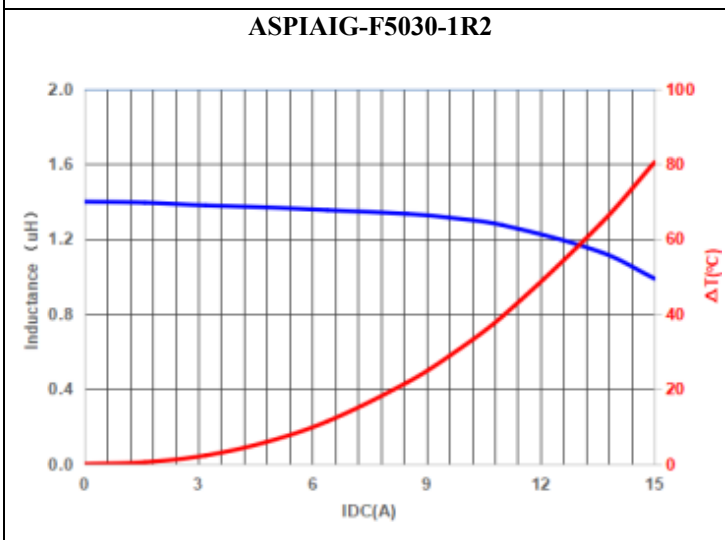
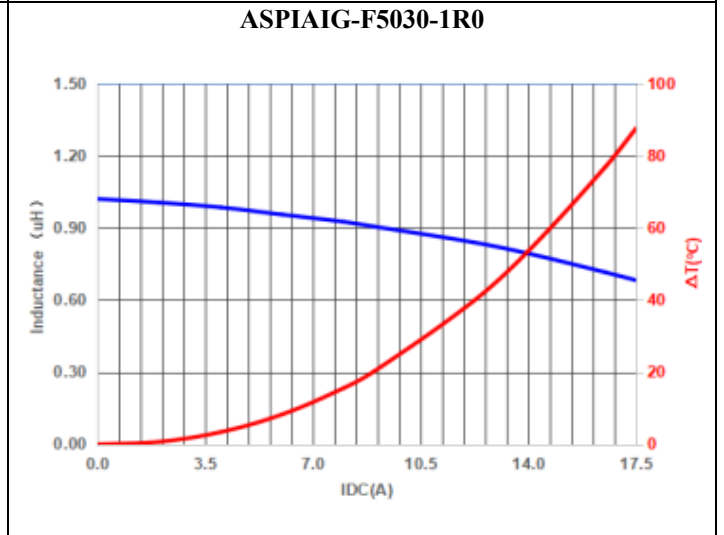
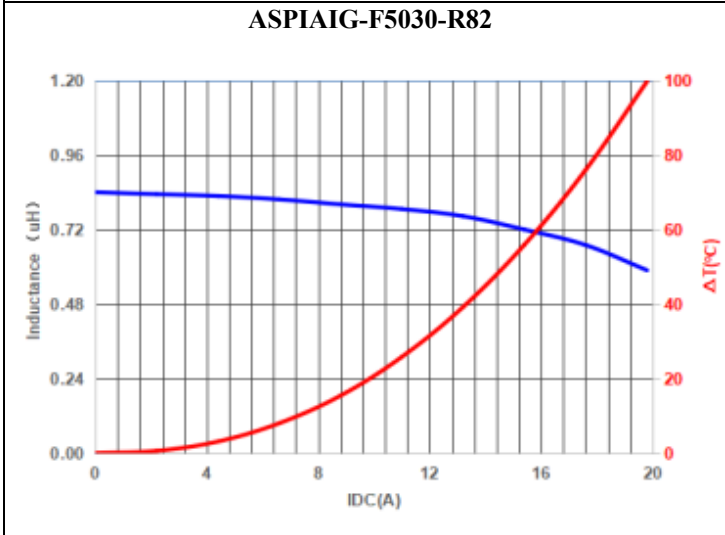
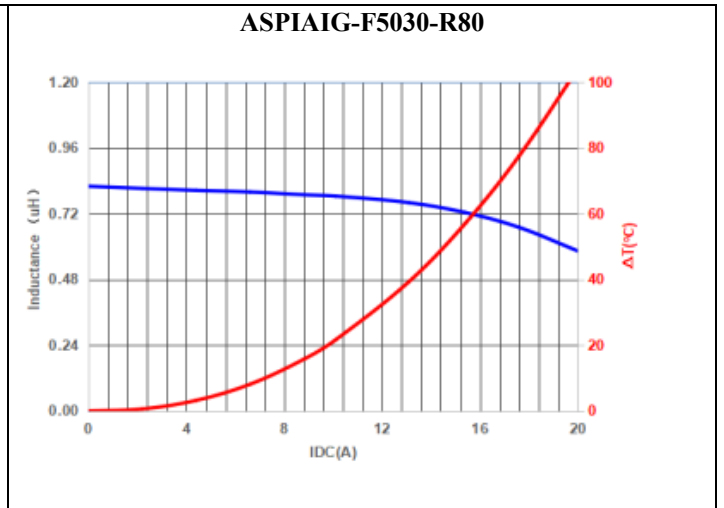
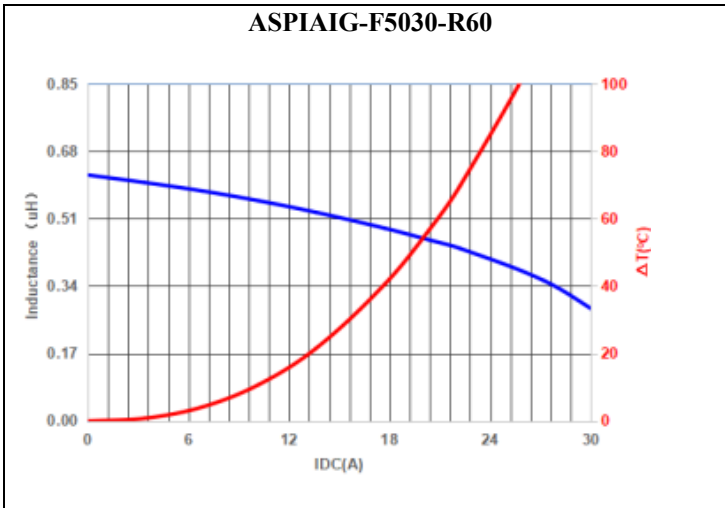

5101 Hidden Creek Ln Spicewood TX 78669  
 Phone: 512-371-6159 | Fax: 512-351-8858  
 For terms and conditions of sales, please visit:  
[www.abracon.com](http://www.abracon.com)

REVISION A : 11/10/2021

ABRACON IS  
 ISO9001-2015  
 CERTIFIED

# Molded SMD Power Inductor



## ASPIAIG-F5030 Series

Request Samples



Check Inventory



5.5 x 5.3 x 2.9 mm  
RoHS/RoHS II Compliant  
MSL Level = 1

ASPIAIG-F5030-1R8

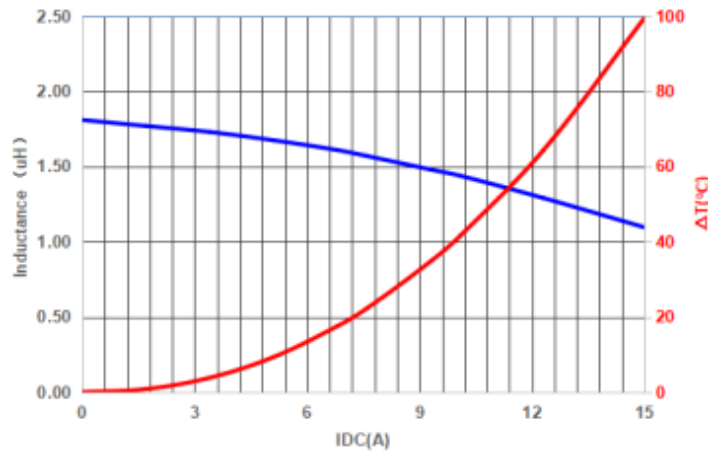

ASPIAIG-F5030-2R2

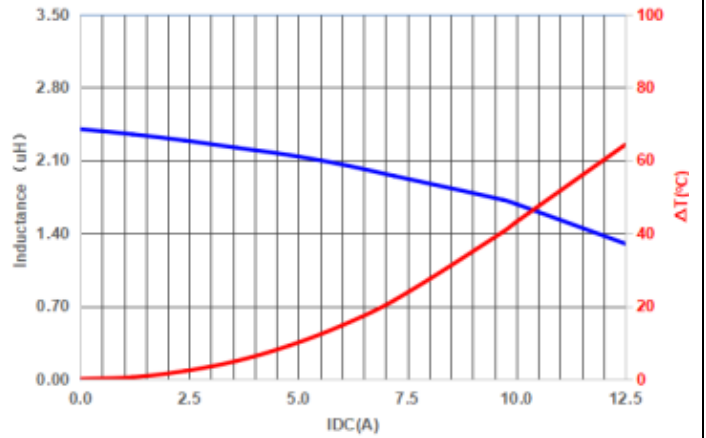

ASPIAIG-F5030-3R3

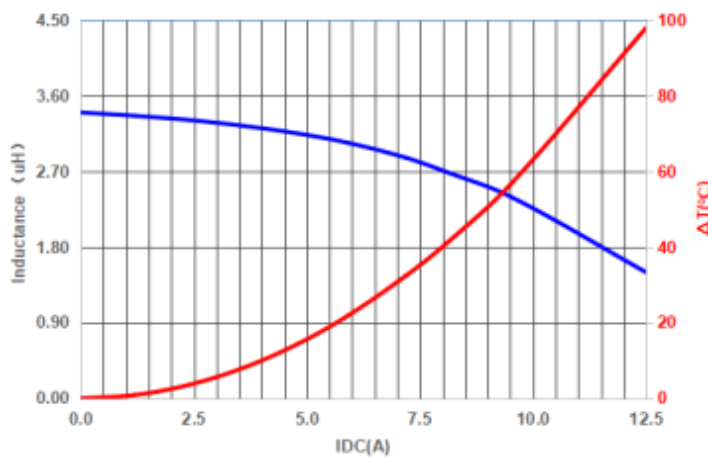

ASPIAIG-F5030-4R7

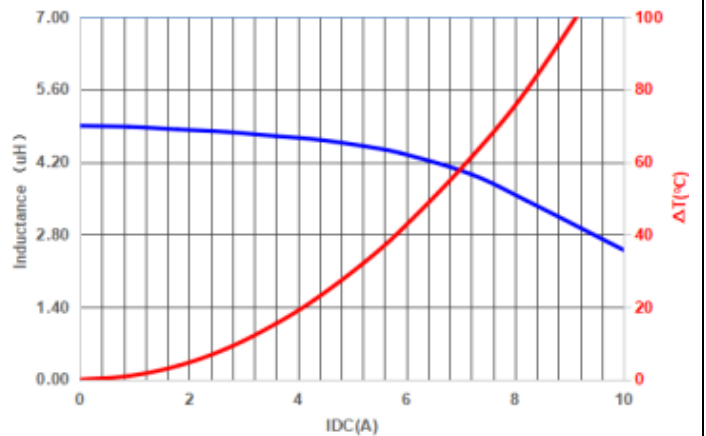

# Molded SMD Power Inductor



ASPIAIG-F5030 Series

Request Samples

Check Inventory

5.5 x 5.3 x 2.9 mm  
 RoHS/RoHS II Compliant  
 MSL Level = 1

## Mechanical Specifications

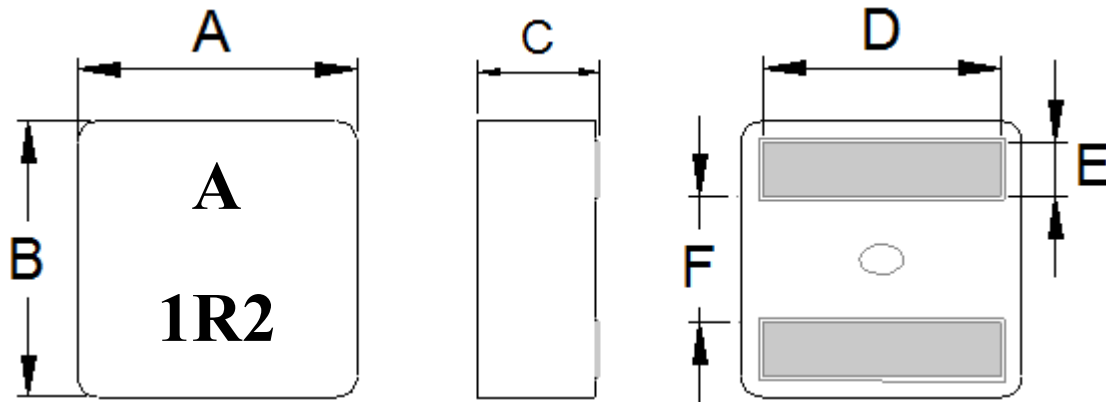

Series	A	B	C	D	E	F
ASPIAIG-F5030	6.0 ± 0.2	5.7 ± 0.2	2.9 ± 0.2	4.3 ± 0.3	1.1 ± 0.2	2.3 ± 0.25

## Recommended Land Pattern

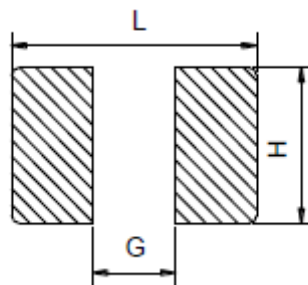

L Typ.	G Typ.	H Typ.
4.5	2.0	4.7

Dimension: mm

# Molded SMD Power Inductor



ASPIAIG-F5030 Series

Request Samples



Check Inventory



5.5 x 5.3 x 2.9 mm  
RoHS/RoHS II Compliant  
MSL Level = 1

## Part Identification

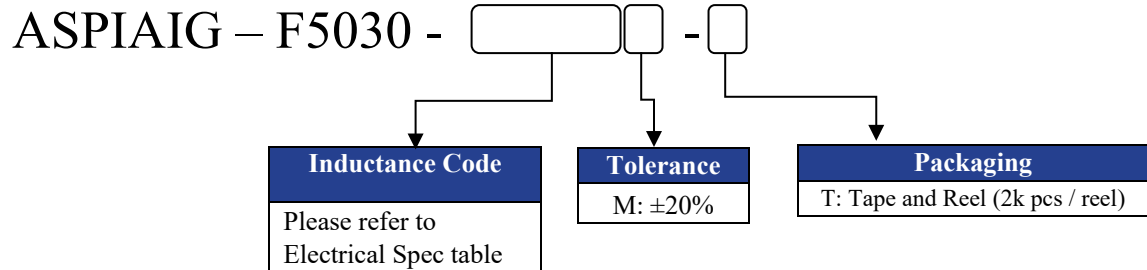

## Marking

Marking Method: Ink

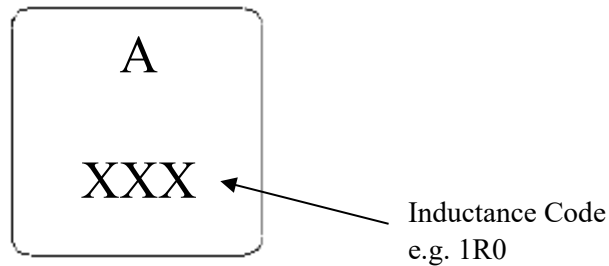

## Materials

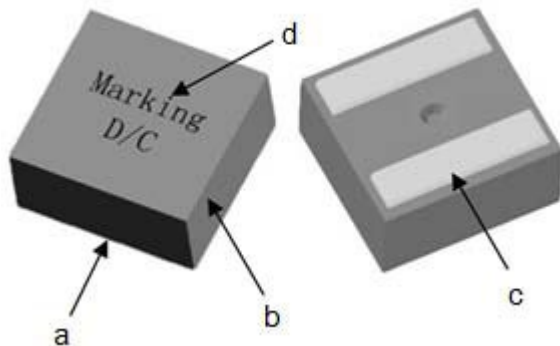

	Components	Material
a	Core	Alloy powder
b	Wire	220 deg. C Flat Wire
c	Solder	100% Pb free solder
d	Ink	Halogen-free ketone

# Molded SMD Power Inductor



ASPIAIG-F5030 Series

Request Samples



Check Inventory



5.5 x 5.3 x 2.9 mm  
RoHS/RoHS II Compliant  
MSL Level = 1

## Reflow Profile

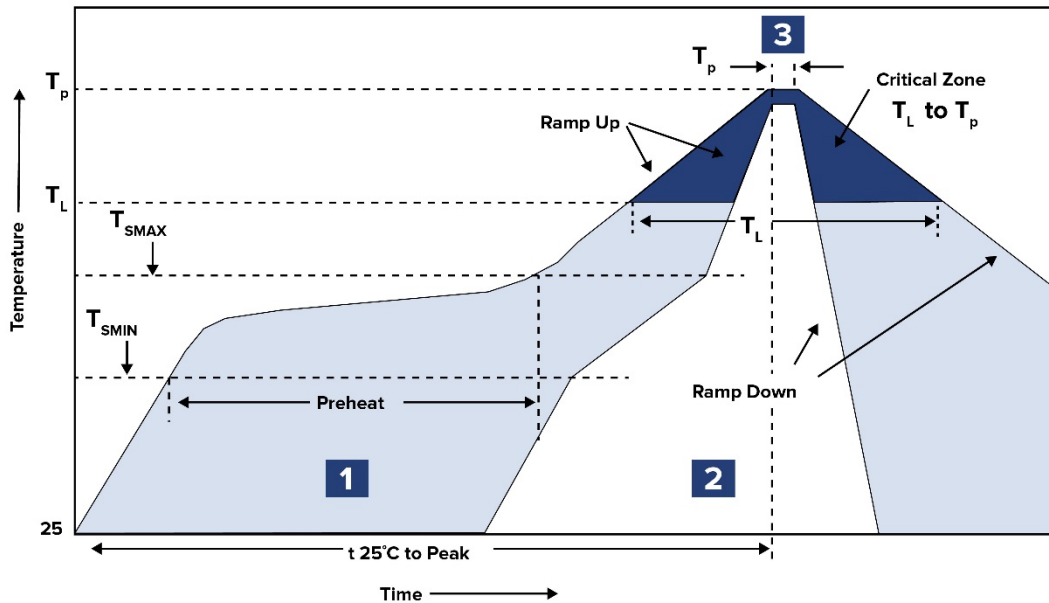

Zone	Description	Temperature	Times
1	Preheat	$T_{SMIN} \sim T_{SMAX}$ 150°C ~ 200°C	60 ~ 180 sec.
2	Reflow	$T_L$ 217°C	60 ~ 150 sec.
3	Peak heat	$T_P$ 260°C	10 sec. MAX

# Molded SMD Power Inductor



**ASPIAIG-F5030 Series**

Request Samples



Check Inventory



**5.5 x 5.3 x 2.9 mm**  
**RoHS/RoHS II Compliant**  
**MSL Level = 1**

## Packaging (Tape & Reel)

**ASPIAIG-F5030: 2000pcs / reel**

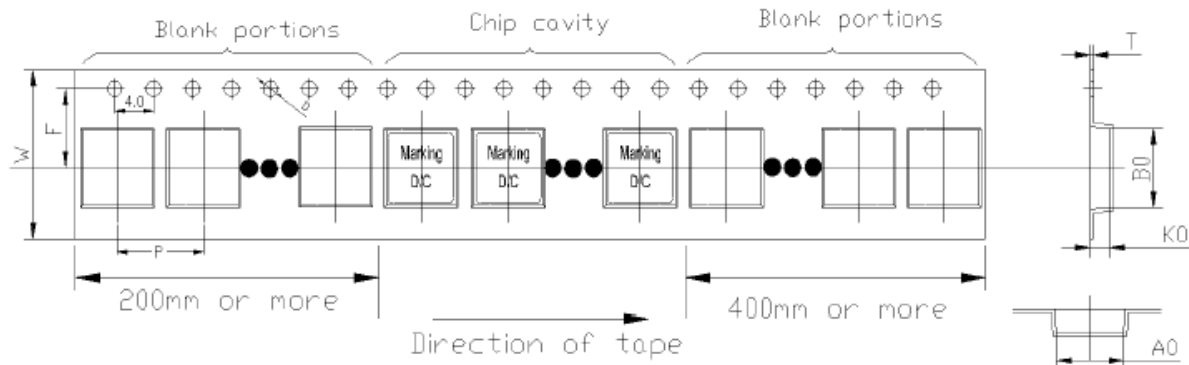

Series	W	F	P	D	A <sub>0</sub>	B <sub>0</sub>	T	K <sub>0</sub>
ASPIAIG-F5030	16.0±0.3	7.5±0.1	8.0±0.1	1.5±0.1	5.8±0.1	5.6 ±0.1	0.35±0.05	3.3±0.1

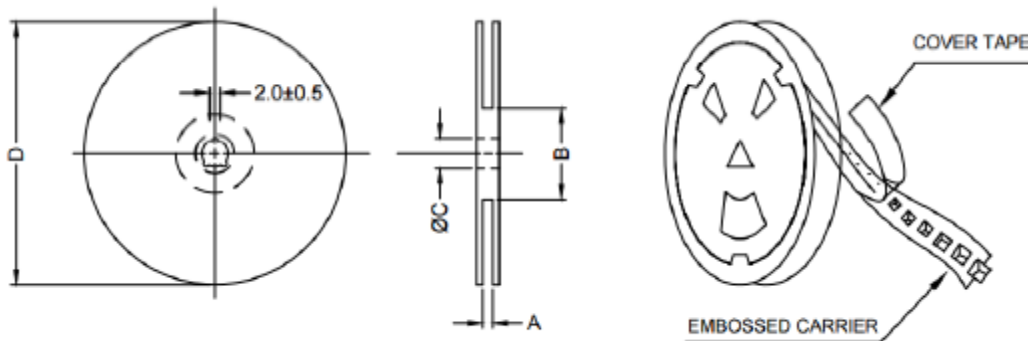

A	B	C	D
16.4+2/-0	100 ± 2	13.0+0.5/-0.2	330

**Dimension: mm**

**ATTENTION:** Abracon LLC's products are COTS – Commercial-Off-The-Shelf products; suitable for Commercial, Industrial and, where designated, Automotive Applications. Abracon's products are not specifically designed for Military, Aviation, Aerospace, Life-dependent Medical applications or any application requiring high reliability where component failure could result in loss of life and/or property. For applications requiring high reliability and/or presenting an extreme operating environment, written consent and authorization from Abracon LLC is required. Please contact Abracon LLC for more information.



5101 Hidden Creek Ln Spicewood TX 78669  
 Phone: 512-371-6159 | Fax: 512-351-8858  
 For terms and conditions of sales, please visit:  
[www.abracon.com](http://www.abracon.com)

**REVISION A : 11/10/2021**

ABRACON IS  
 ISO9001-2015  
 CERTIFIED